

REV	DATE	DESCRIPTION
00	21APR2021	INITIAL REVISION

- NOTES:
- (⊥) ALL VERTICAL SUPPORTS ARE PERPENDICULAR.
 - FLATNESS OF .5MM IS APPLIED BY DEFAULT.
 - ⊲ WELD BEAD OF 2MM RADIUS IS FOLLOWED.
 - ▽▽ SURFACE FINISH MEDIUM TO SMOOTH IS USED.
 - ALL TUBES ARE AS PER APL APOLLO STANDARD. CHANGES MAY EFFECT THE LOAD CAPACITY.
 - ALL HORIZONTAL AND VERTICAL TUBES ARE PERPENDICULAR TO EACH OTHER WITH ±1 DEG.
 - FINE WELDING IS REQUIRED AS PER MENTIONED DETAILS AND FINISHING.
 - HIGHER CURRENT WELDING MAY AFFECT THE BRITTLNESS OF MATERIAL WHICH LATER MAY RAISE TO WEAKENING OF STRUCTURE.
 - FABRICATORS ARE ALLOWED TO USE FITTINGS/FRAMES/SUPPORTS AS NEEDED AND THE SAME MUST BE COMMUNICATED BACK TO ENGINEERING TEAM.
 - BOP COMPONENT WEIGHTS ARE FOR REFERENCE ONLY AND SUBJECTED TO CHANGE PER PURCHASED COMPONENTS.

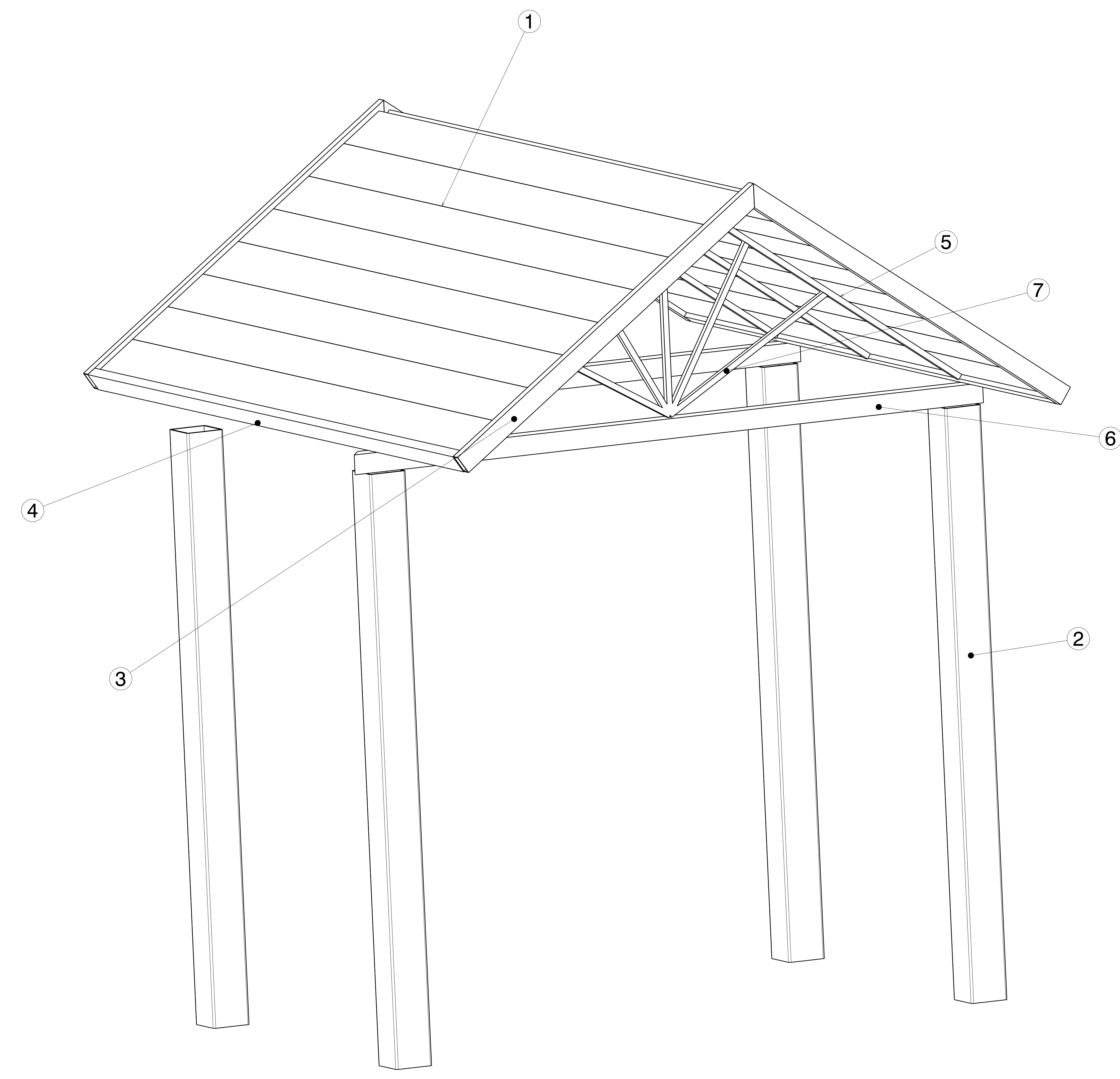

Isometric view
Scale: 1:5

ITEM NO.	PART NUMBER	DESCRIPTION	QTY.	Wt (Kg)/Each
9	SHS FRAME 6	15 X 15 X 0.8 X 541	1	0.19
8	SHS FRAME 5	15 X 15 X 0.8 X 445	2	0.15
7	SHS FRAME 4	15 X 15 X 0.8 X 525	2	0.18
6	SHS FRAME 3	50 X 50 X 1.6 X 1765	2	3.4
5	SHS FRAME 2	15 X 15 X 0.8 X 1000	6	0.35
4	RHS FRAME 2	50 X 25 X 2 X 2000	2	4.45
3	RHS FRAME 1	50 X 25 X 2 X 1050	4	2.30
2	SHS FRAME 1	100 X 100 X 4 X 1500	4	17.9
1	PLANK 1	125 X 25 X 2 X 2000	16	9.2

This drawing is our property. It can't be reproduced or communicated without our written agreement. www.p2p.ind.in		APL APOLLO TUBES LTD.	
DRAWN BY XX		DATE 21APR2021	
CHECKED BY P2P Analysis & Solutions		DATE 21APR2021	
DESIGNED BY P2P Analysis & Solutions		DATE 21APR2021	
DRAWING TITLE SHED		SIZE A0	DRAWING NUMBER P2P APR 21-14
UNLESS OTHERWISE SPECIFIED DIMENSION ARE IN MM		SCALE As Indicated	WEIGHT (kg) xxxx
VIEWS: THIRD ANGLE PROJECTION		SHEET 1 OF 3	

UNLESS OTHERWISE SPECIFIED DIMENSION ARE IN MM
VIEWS:
THIRD ANGLE
PROJECTION

REV	DATE	DESCRIPTION
00	21APR2021	INITIAL REVISION

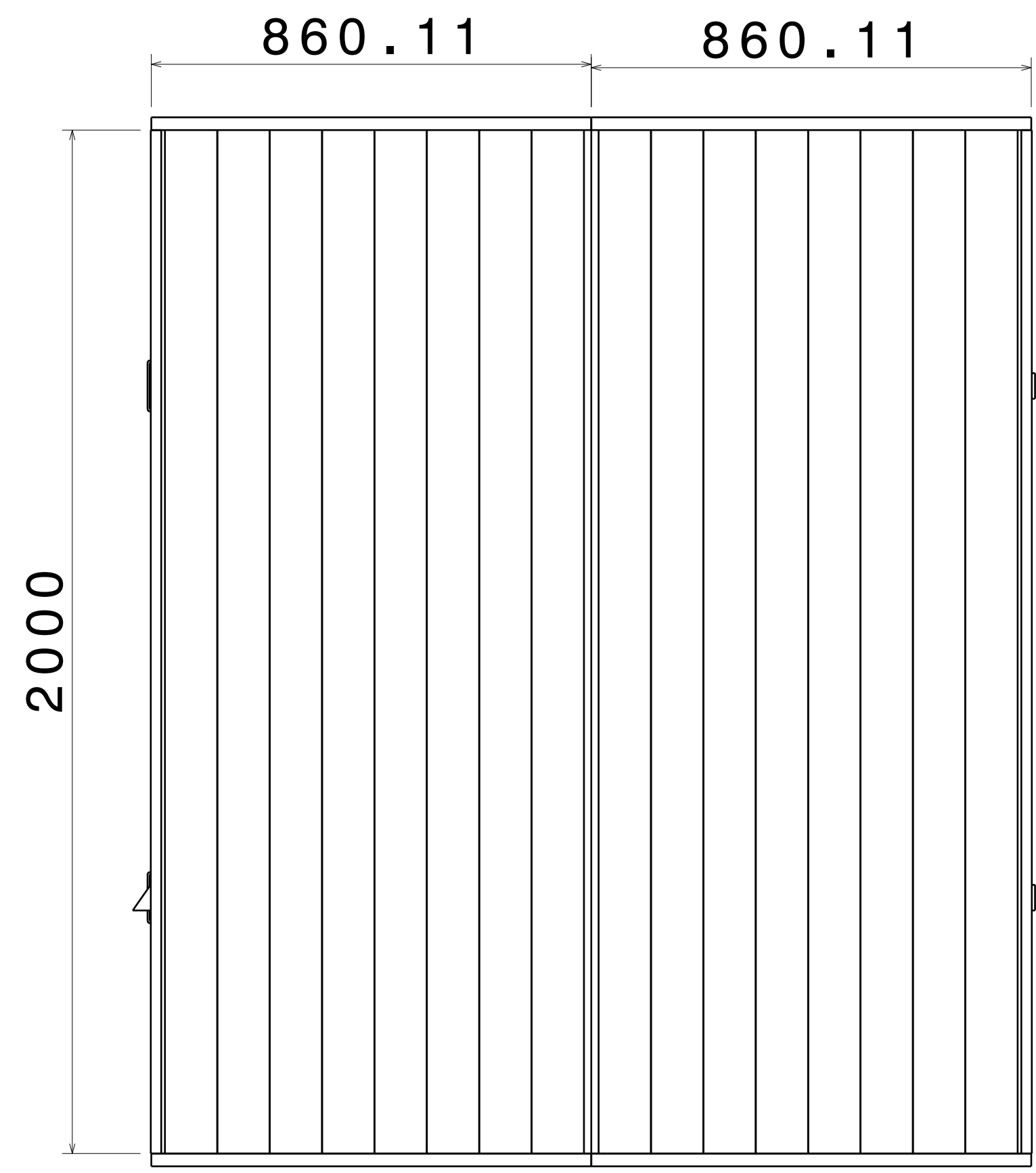

Top view
Scale: 1:10

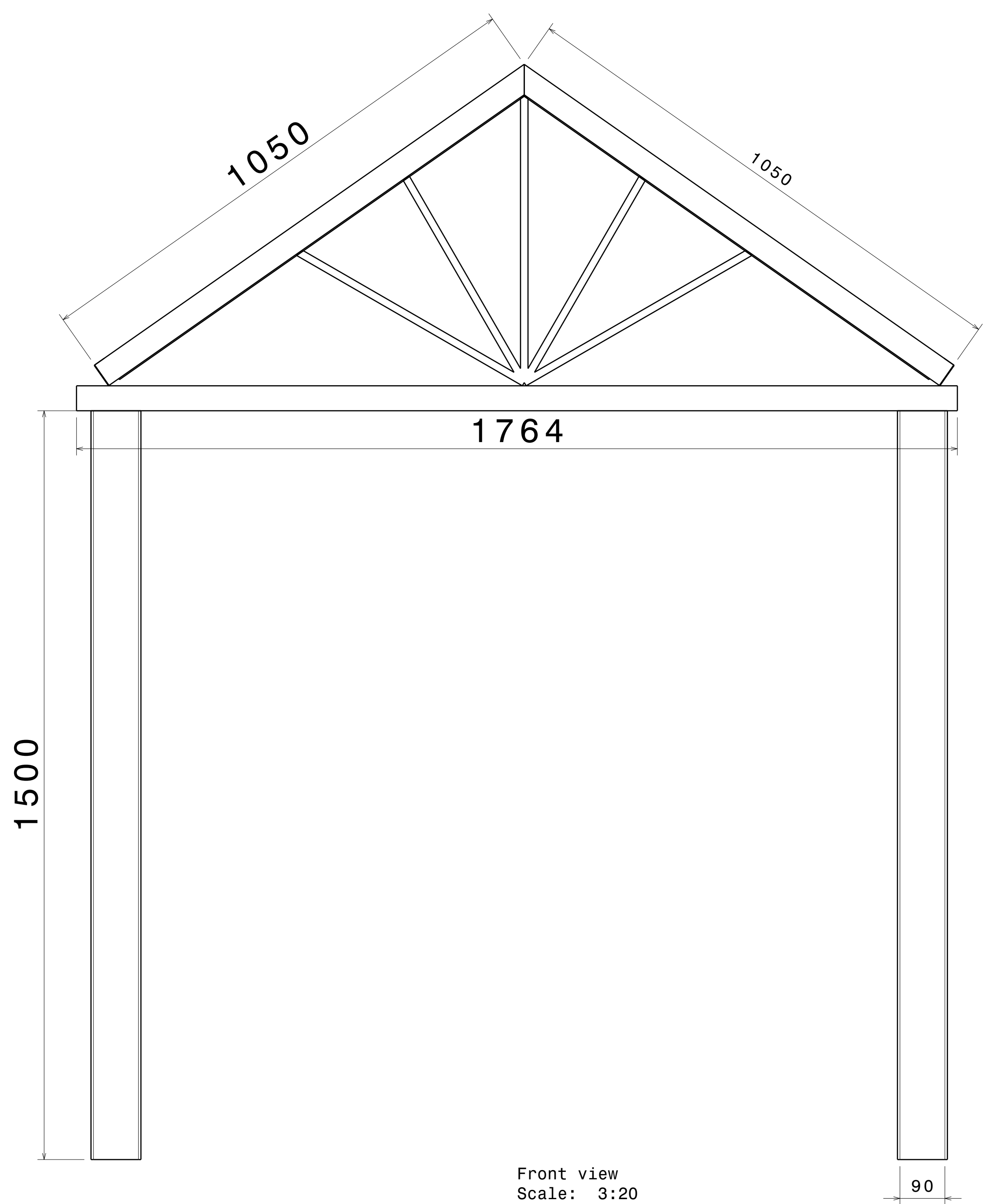

Front view
Scale: 3:20

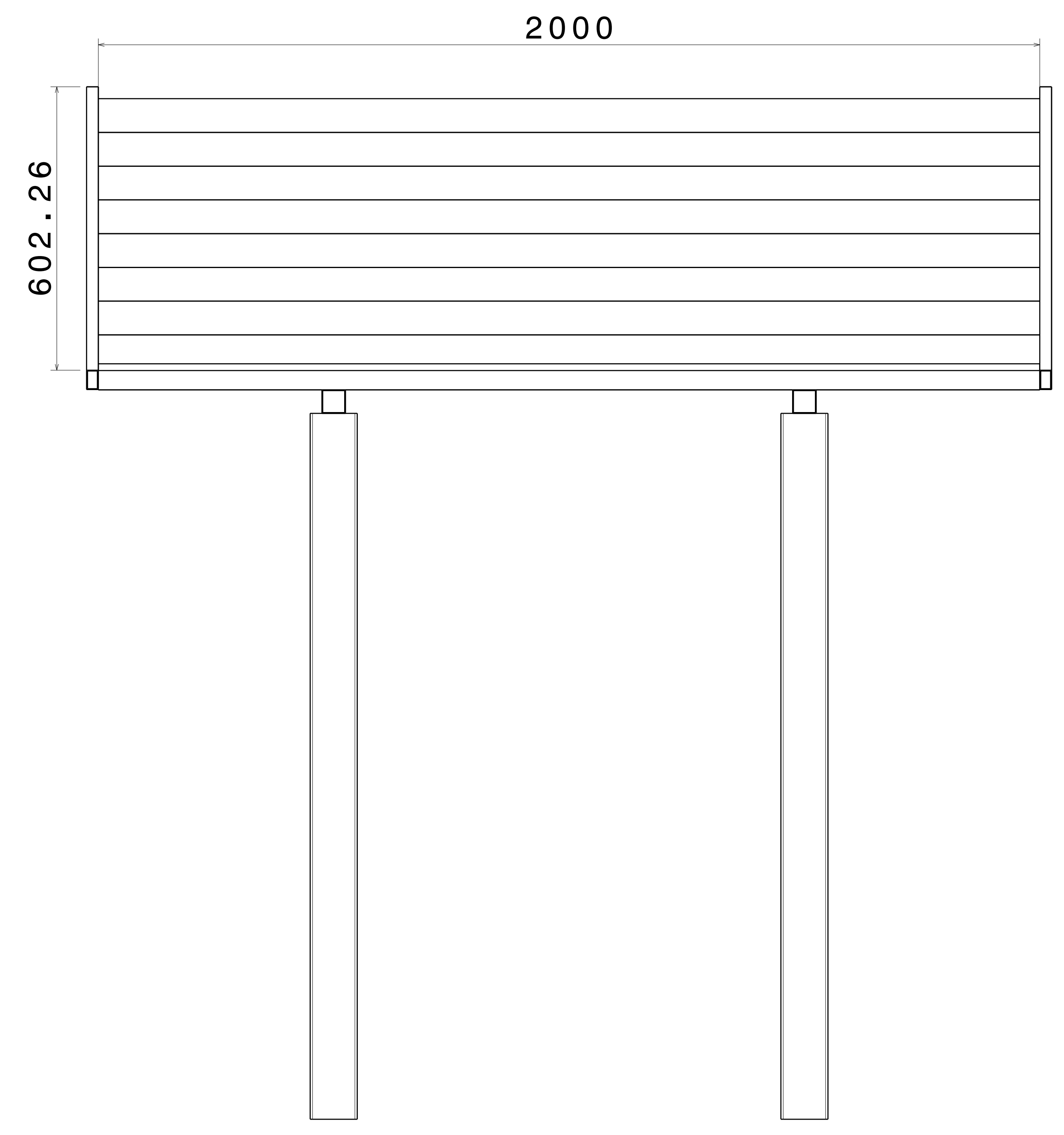

Right view
Scale: 3:20

UNLESS OTHERWISE SPECIFIED DIMENSION ARE IN MM
VIEWS: THIRD ANGLE PROJECTION

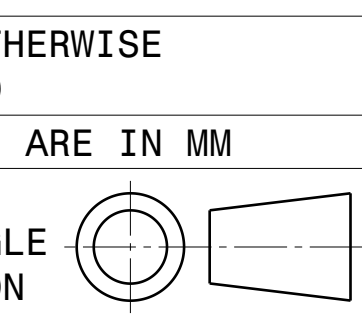

This drawing is our property. It can't be reproduced or communicated without our written agreement.
www.p2p.ind.in

DRAWN BY: SB
CHECKED BY: P2P Analysis & Solutions
DESIGNED BY: P2P Analysis & Solutions

DATE: 21APR2021		DRAWING TITLE: SHED	
SIZE: A0	DRAWING NUMBER: P2P APR 21-14	REV: 00	
SCALE: NONE	WEIGHT (kg): XXX	SHEET 2 OF 3	



REV	DATE	DESCRIPTION
00	21APR2021	INITIAL REVISION

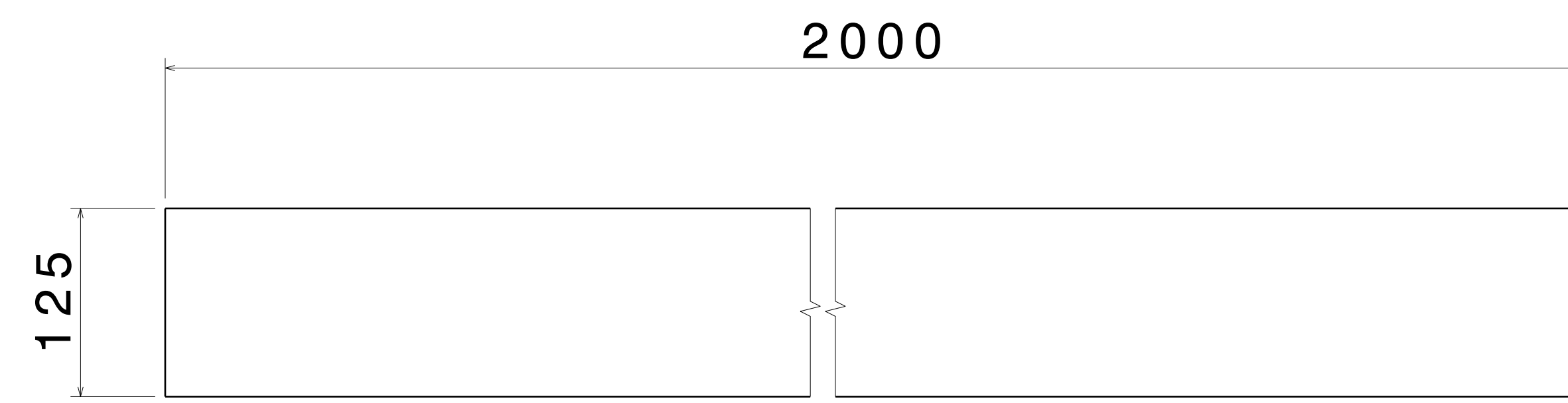

ITEM 1

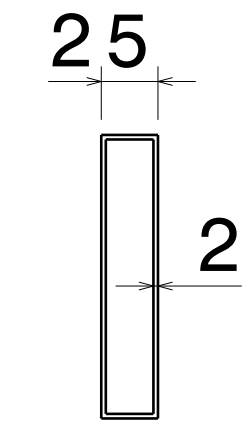

Right view
Scale: 3:10

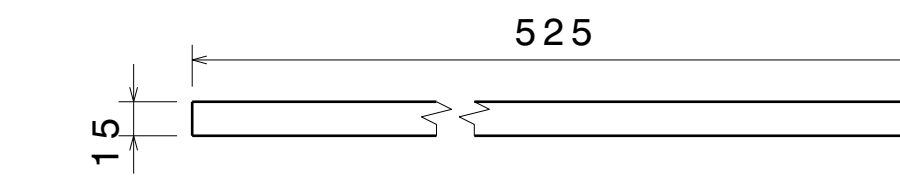

ITEM 7

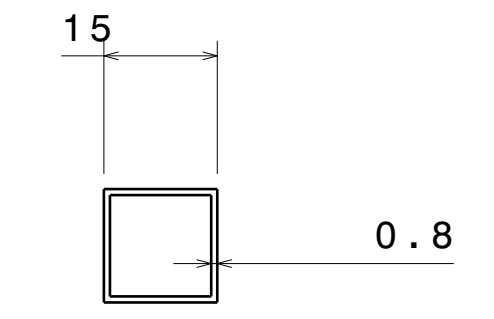

SAME FOR
ITEM 7, 8 & 9

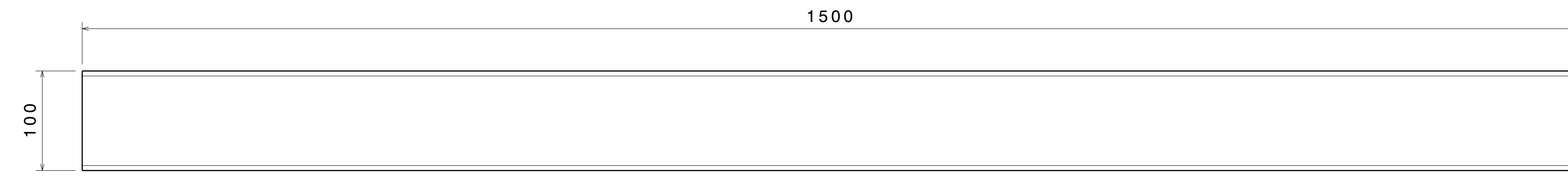

ITEM 2

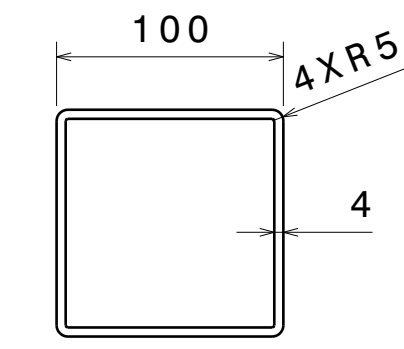

Right view
Scale: 3:10

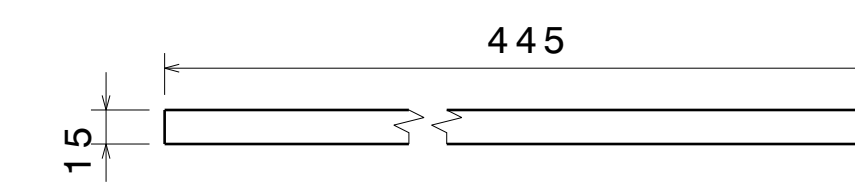

ITEM 8

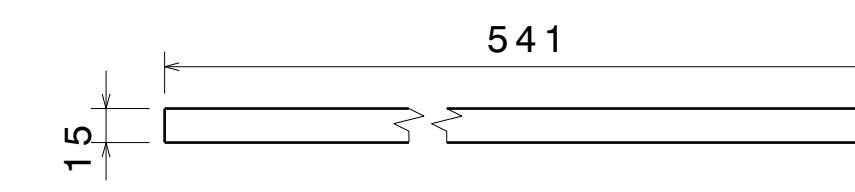

ITEM 9

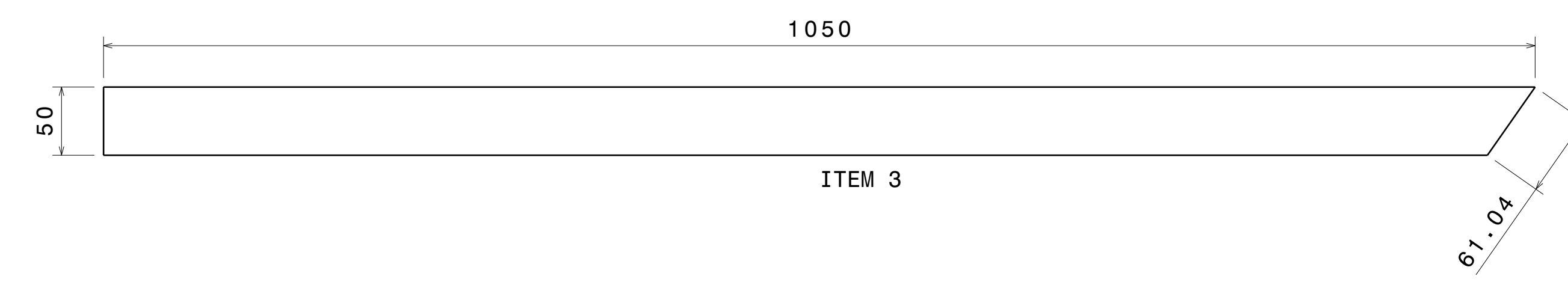

ITEM 3

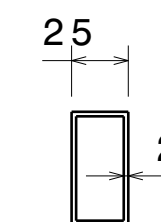

Right view
Scale: 3:10

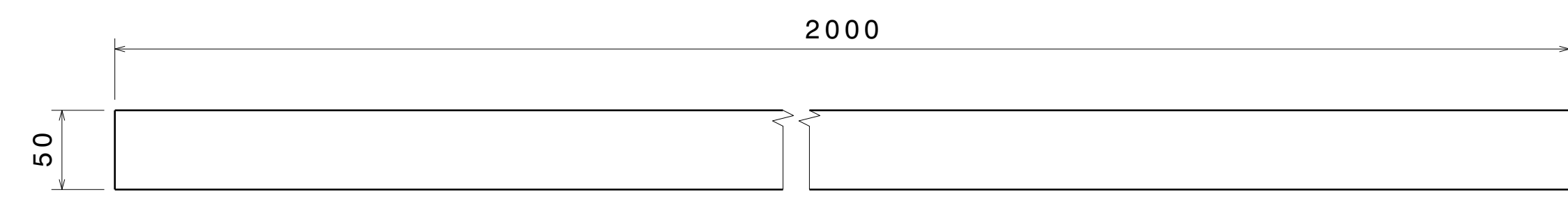

ITEM 4

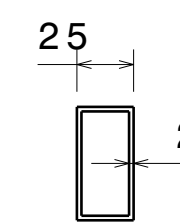

Right view
Scale: 3:10

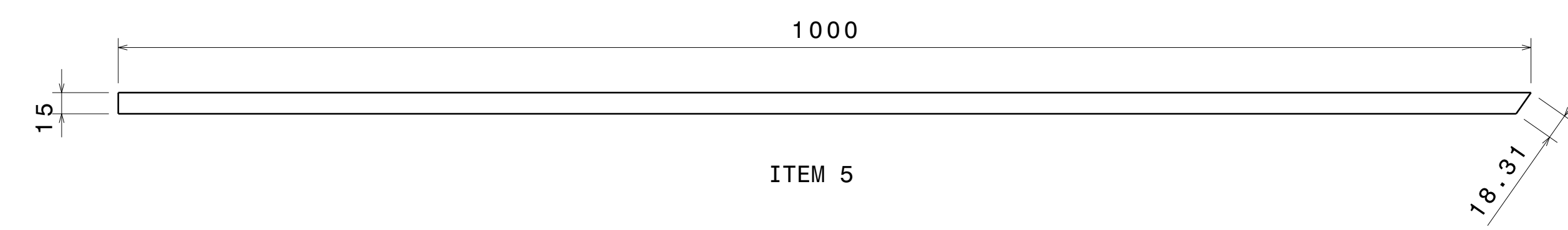

ITEM 5

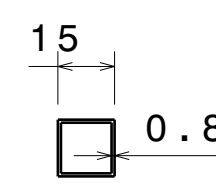

Right view
Scale: 1:2

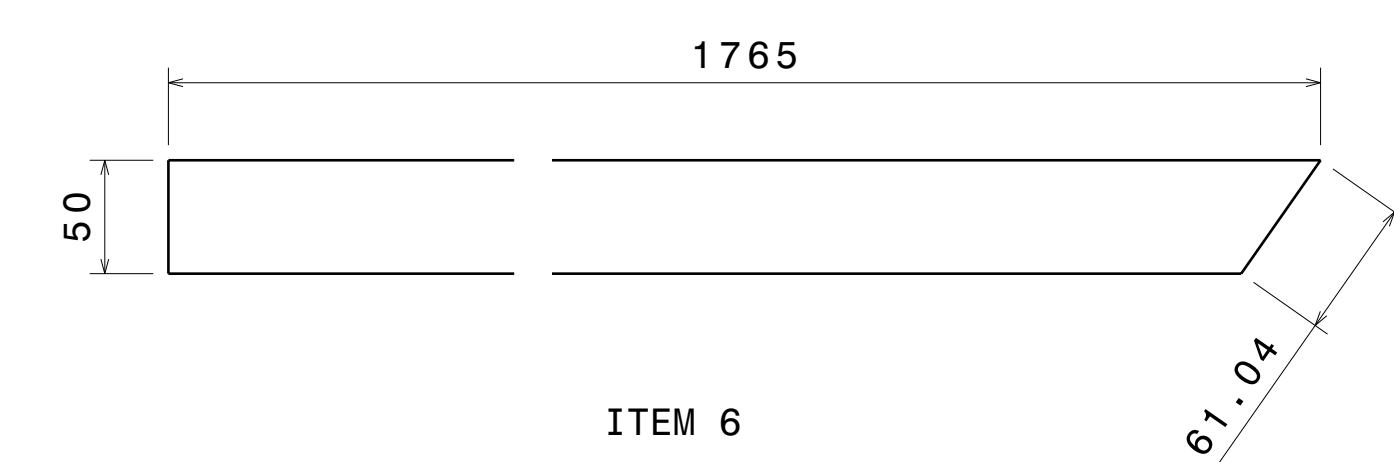

ITEM 6

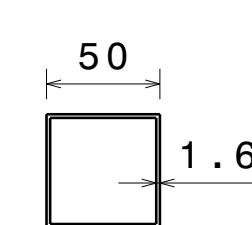

Right view
Scale: 3:10

UNLESS OTHERWISE SPECIFIED DIMENSION ARE IN MM
VIEWS: THIRD ANGLE PROJECTION

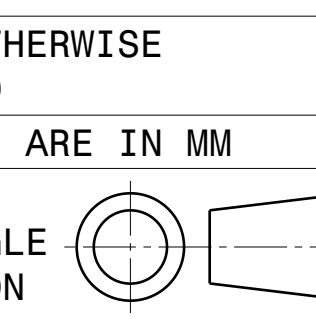

This drawing is our property. It can't be reproduced or communicated without our written agreement.
www.p2p.ind.in

DRAWN BY	SB	DATE	21APR2021
CHECKED BY	P2P Analysis & Solutions	DATE	21APR2021
DESIGNED BY	P2P Analysis & Solutions	DATE	21APR2021

APL APOLLO TUBES LTD.	
DRAWING TITLE	
SHED	
SIZE	A0
DRAWING NUMBER	P2P_APR_21-14
REV	00
SCALE	NONE
WEIGHT (kg)	XXX
SHEET 3 OF 3	