

REV/DATE	DESCRIPTION
00 / 3DEC2020	INITIAL REVISION

- NOTES:
- (⊥) ALL VERTICAL SUPPORTS ARE PERPENDICULAR.
  - FLATNESS OF .5MM IS APPLIED BY DEFAULT.
  - ⊲ WELD BEAD OF 2MM RADIUS IS FOLLOWED.
  - ▽ SURFACE FINISH MEDIUM TO SMOOTH IS USED.
  - ALL TUBES ARE AS PER APL APOLLO STANDARD. CHANGES MAY EFFECT THE LOAD CAPACITY.
  - ALL HORIZONTAL AND VERTICAL TUBES ARE PERPENDICULAR TO EACH OTHER WITH ±1 DEG.
  - FINE WELDING IS REQUIRED AS PER MENTIONED DETAILS AND FINISHING.
  - HIGHER CURRENT WELDING MAY AFFECT THE BRITTLENESS OF MATERIAL WHICH LATER MAY RAISE TO WEAKENING OF STRUCTURE.
  - FABRICATORS ARE ALLOWED TO USE FITTINGS/FRAMES/SUPPPORTS AS NEEDED AND THE SAME MUST BE COMMUNICATED BACK TO ENGINEERING TEAM.
  - BOP COMPONENT WEIGHTS ARE FOR REFERENCE ONLY AND SUBJECTED TO CHANGE PER PURCHASED COMPONENTS.

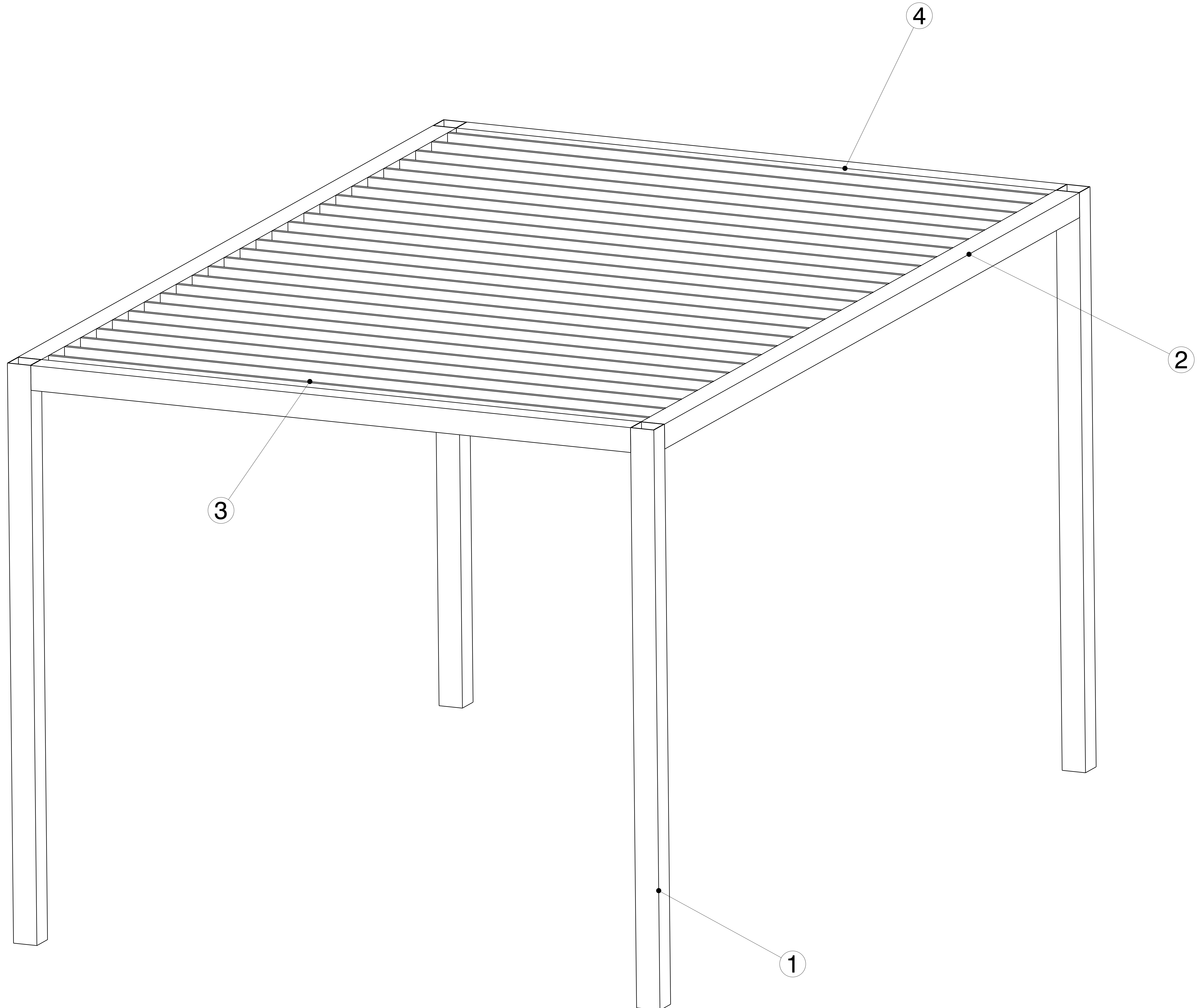

ISOMETRIC VIEW  
SCALE:1:10

ITEM NO.	PART NUMBER	DESCRIPTION	QTY.	Wt (kg)/Each
4	SHS FRAME 3	150 X 150 X 4 X 3850	2	70.69
3	RHS PLANK 1	150 X 25 X 1.6 X 3850	26	16.64
2	SHS FRAME 2	150 X 150 X 4 X 5850	2	107.41
1	SHS FRAME 1	150 X 150 X 4 X 3500	4	64.26

This drawing is our property. It can't be reproduced or communicated without our written agreement.		<b>APL APOLLO TUBES LTD.</b> 	
DRAWN BY		DATE	
VM		3DEC2020	
CHECKED BY		DATE	
P2P Analysis & Solutions		3DEC2020	
DESIGNED BY		DATE	
P2P Analysis & Solutions		3DEC2020	
DRAWING TITLE		DEC 20 3	
SIZE	DRAWING NUMBER	REV	
A0	P2P DEC 20 3	00	
SCALE	WEIGHT(kg)	Okg	SHEET 1 OF 3
As Indicated			

UNLESS OTHERWISE SPECIFIED DIMENSION ARE IN MM  
VIEWS: THIRD ANGLE PROJECTION

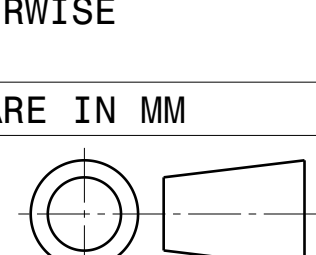

REV	DATE	DESCRIPTION
00	3DEC2020	INITIAL REVISION



FRONT VIEW  
SCALE: 1:15

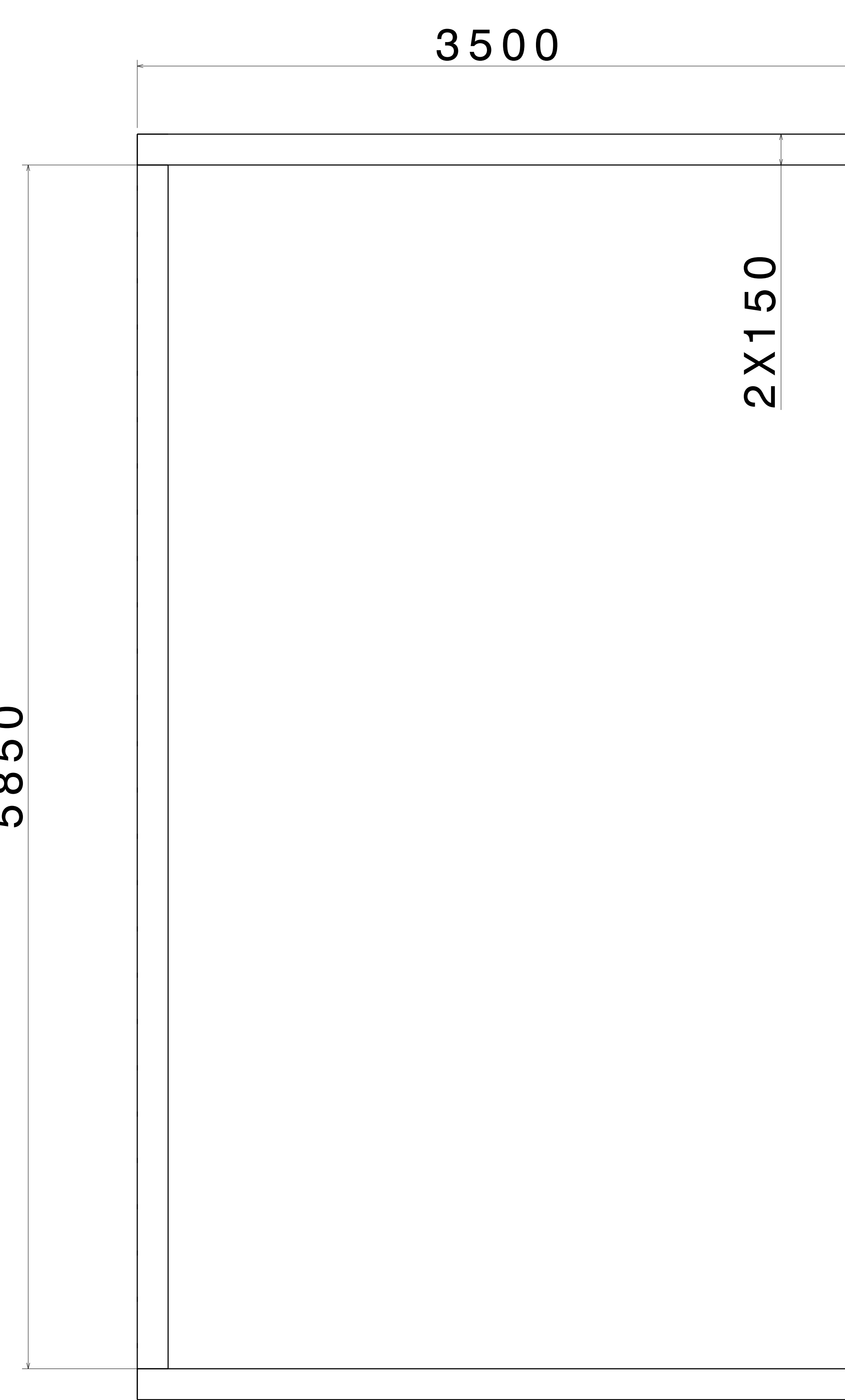

RIGHT VIEW  
SCALE: 1:15

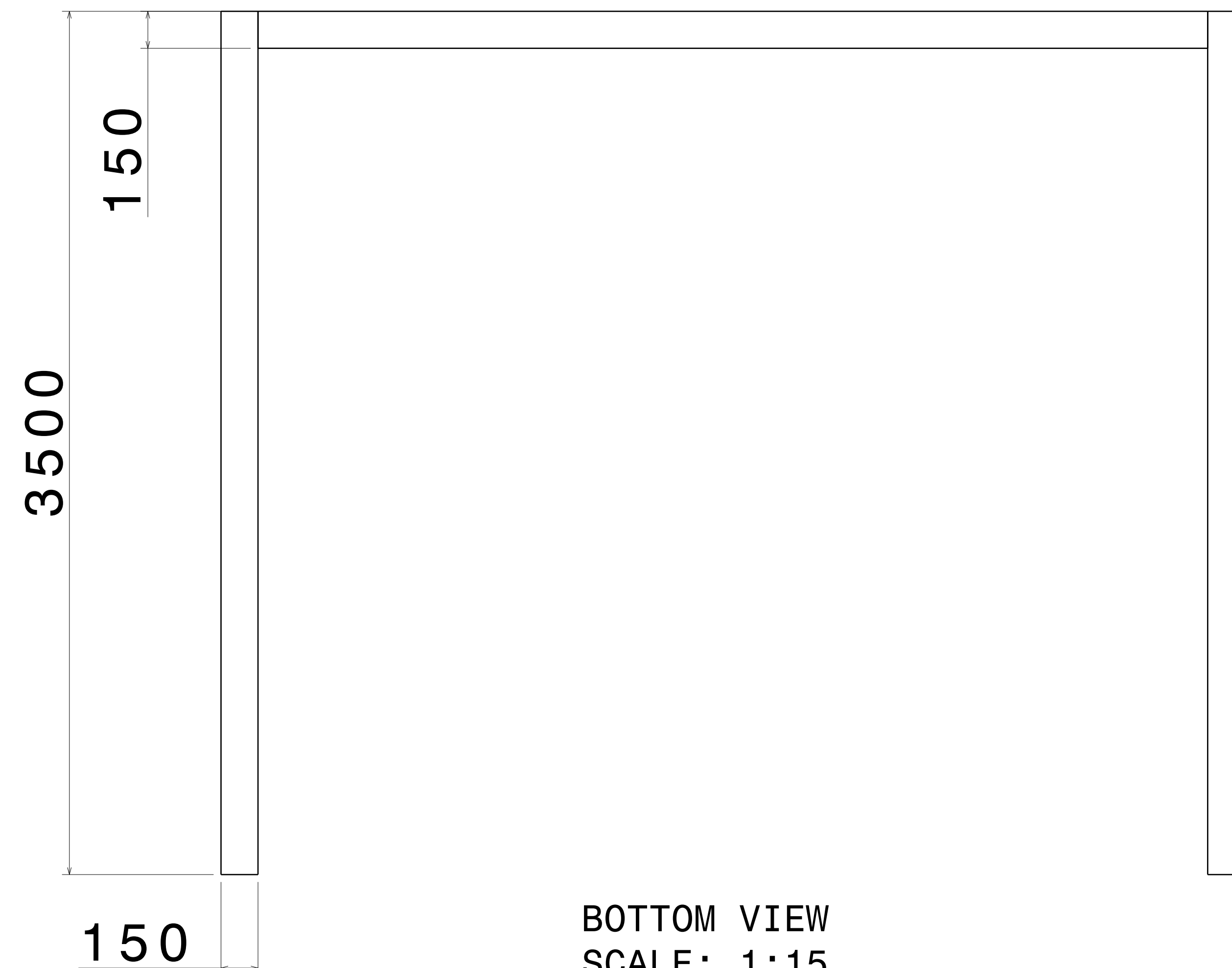

BOTTOM VIEW  
SCALE: 1:15

This drawing is our property. It can't be reproduced or communicated without our written agreement.		APL APOLLO TUBES LTD. 	
DRAWN BY SB		DATE 3DEC2020	
CHECKED BY P2P Analysis & Solutions		DATE 3DEC2020	
DESIGNED BY P2P Analysis & Solutions		DATE 3DEC2020	
SIZE A0	DRAWING NUMBER P2P_DEC 20 3		REV 00
SCALE NONE	WEIGHT (kg)	XXX	SHEET 2 OF 3

UNLESS OTHERWISE SPECIFIED DIMENSION ARE IN MM  
VIEWS: THIRD ANGLE PROJECTION

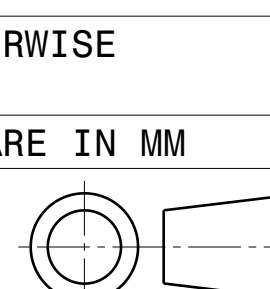

REV	DATE	DESCRIPTION
00	3DEC2020	INITIAL REVISION

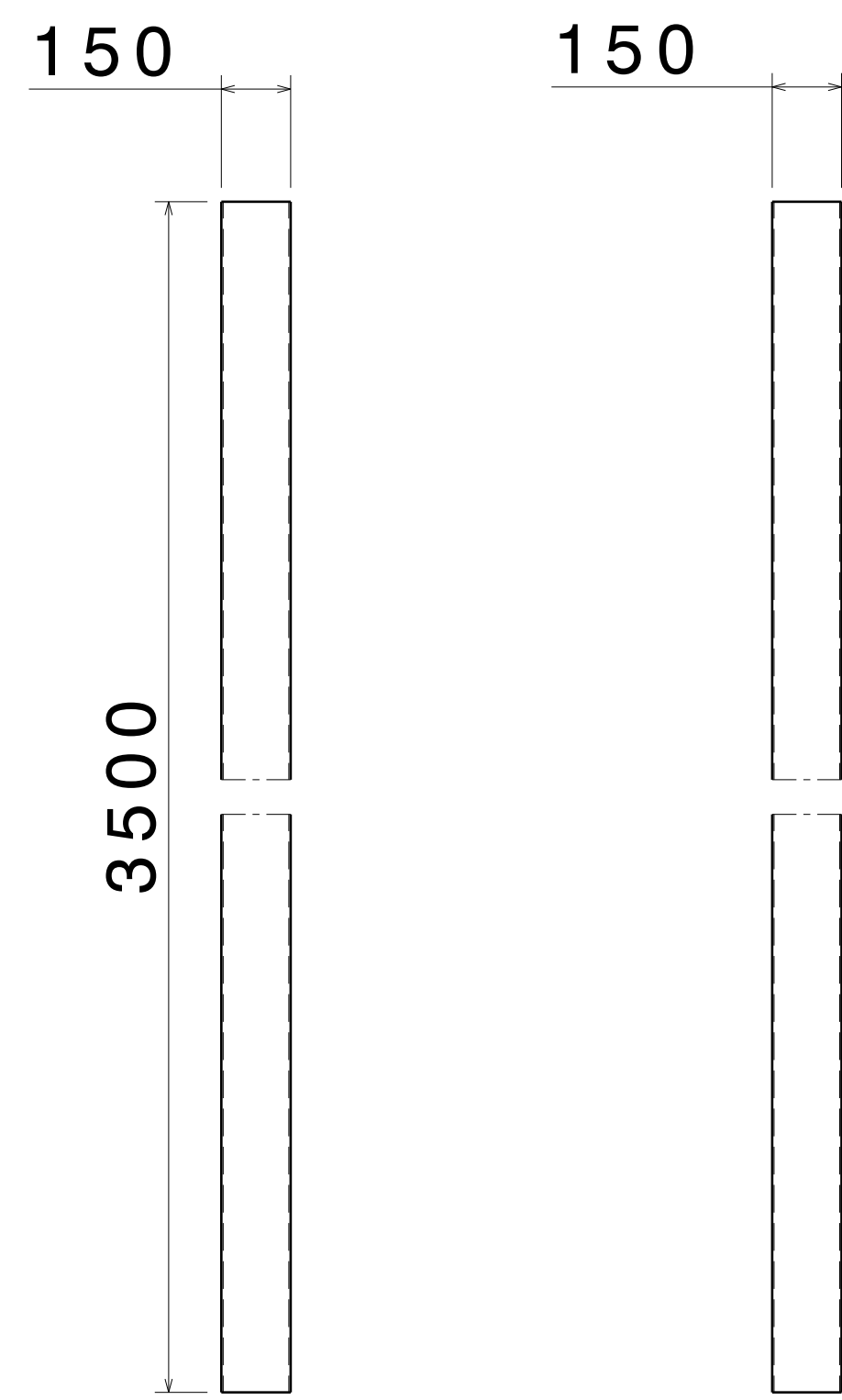

FRONT VIEW RIGHT VIEW  
SCALE: 1:15 SCALE: 1:15  
ITEM 1, SHS FRAME 1  
THICKNESS - 4.0MM

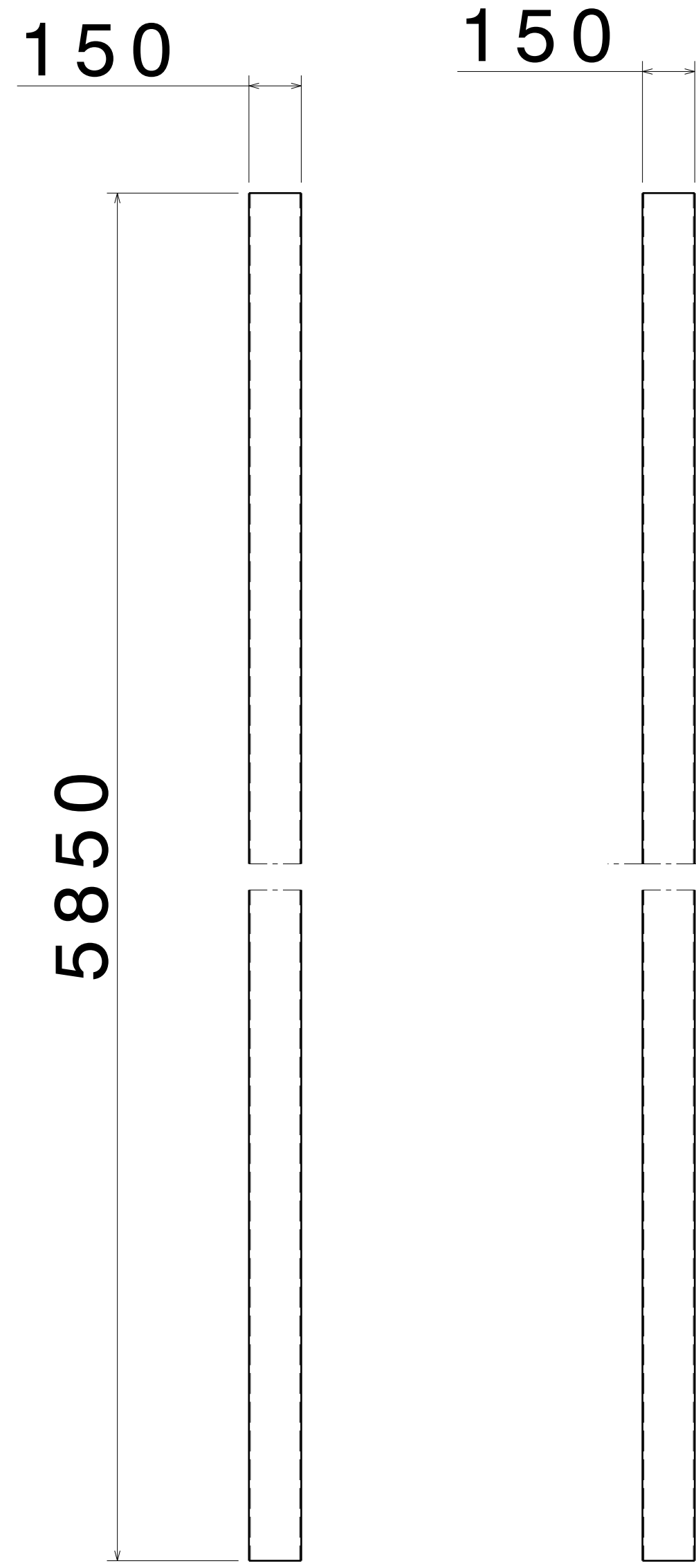

FRONT VIEW RIGHT VIEW  
SCALE: 1:15 SCALE: 1:15  
ITEM 2, SHS FRAME 2  
THICKNESS - 4.0 MM

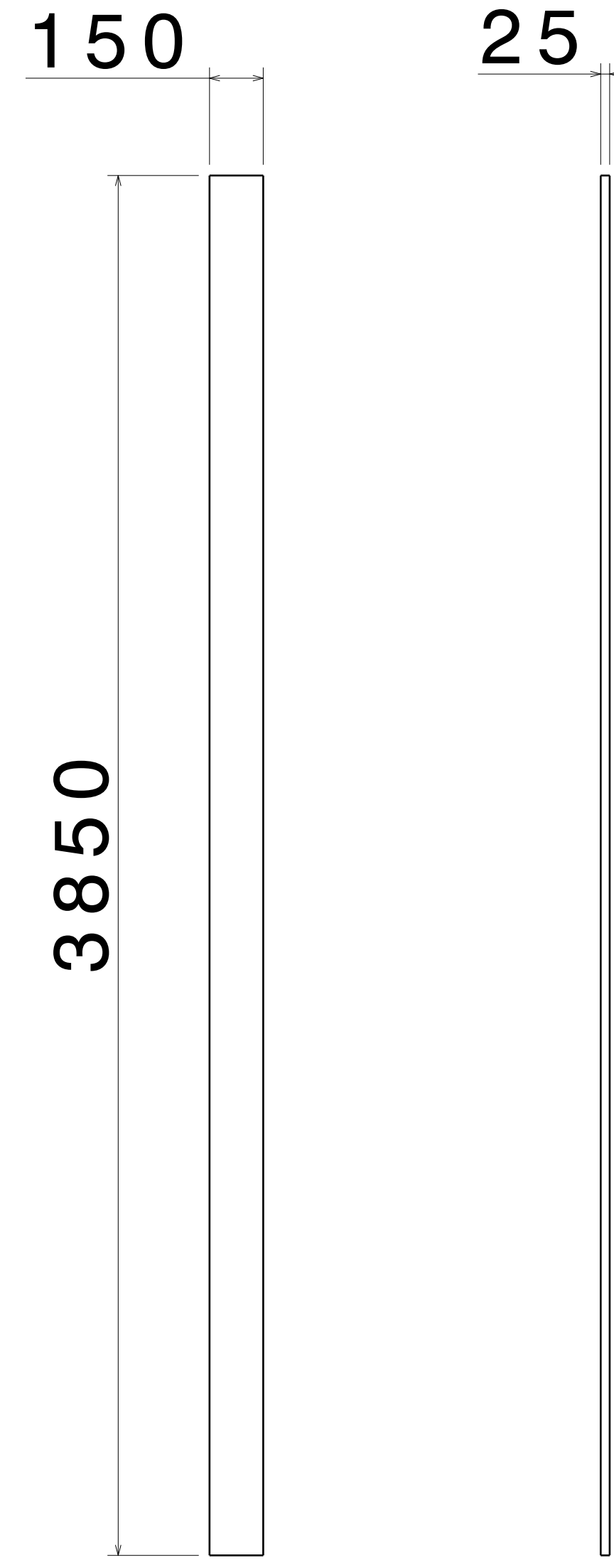

FRONT VIEW RIGHT VIEW  
SCALE: 1:15 SCALE: 1:15  
ITEM 3, RHS PLANK 1  
THICKNESS -1.6 MM

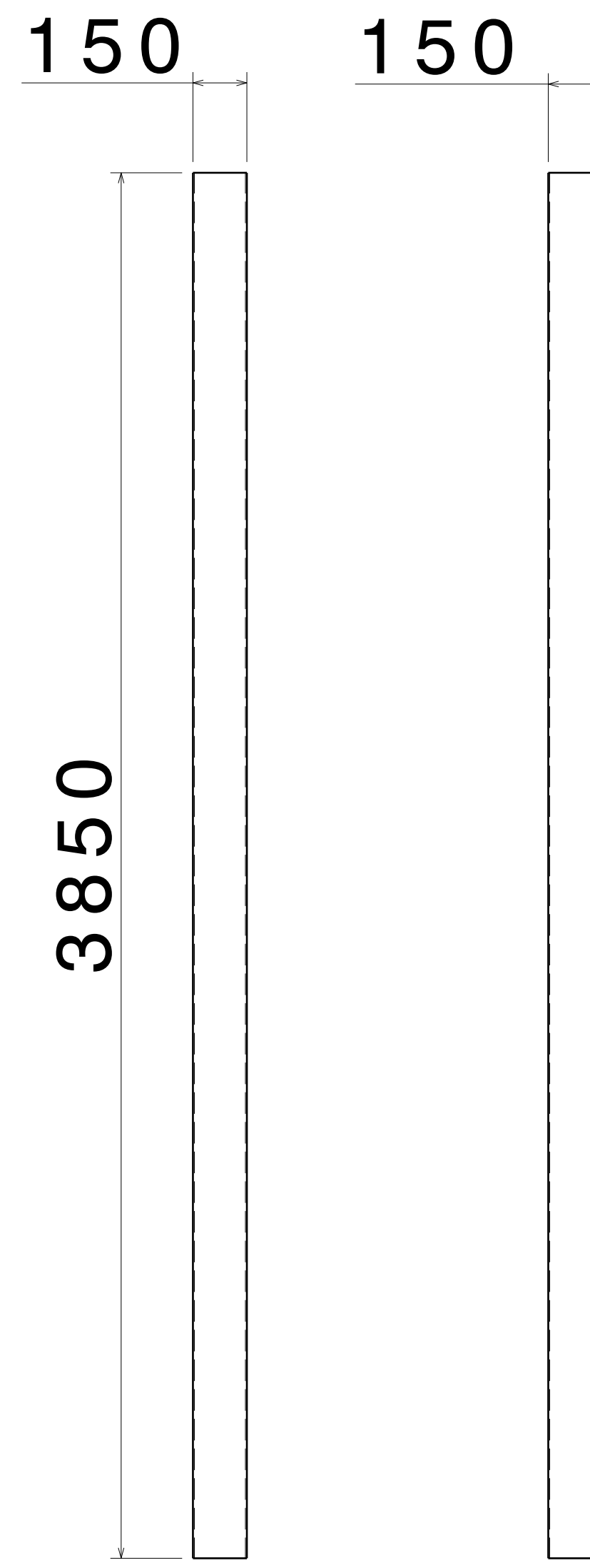

FRONT VIEW RIGHT VIEW  
SCALE: 1:15 SCALE: 1:15  
ITEM 4, SHS FRAME 3  
THICKNESS - 4.0 MM

UNLESS OTHERWISE SPECIFIED DIMENSION ARE IN MM  
VIEWS: THIRD ANGLE PROJECTION

This drawing is our property. It can't be reproduced or communicated without our written agreement.		APL APOLLO TUBES LTD.	
DRAWN BY SB		DATE 3DEC2020	
CHECKED BY P2P Analysis & Solutions		DATE 3DEC2020	
DESIGNED BY P2P Analysis & Solutions		DATE 3DEC2020	
DRAWING TITLE DEC 20 3		SIZE A0	DRAWING NUMBER P2P_DEC 20 3
SCALE NONE		WEIGHT (kg) XXX	REV 00
		SHEET 3 OF 3	