

REV/DATE	DESCRIPTION
00 / 2DEC2020	INITIAL REVISION

- NOTES:
- (⊥) ALL VERTICAL SUPPORTS ARE PERPENDICULAR.
 - FLATNESS OF .5MM IS APPLIED BY DEFAULT.
 - ⊞ WELD BEAD OF 2MM RADIUS IS FOLLOWED.
 - ▽ SURFACE FINISH MEDIUM TO SMOOTH IS USED.
 - ALL TUBES ARE AS PER APL APOLLO STANDARD. CHANGES MAY EFFECT THE LOAD CAPACITY.
 - ALL HORIZONTAL AND VERTICAL TUBES ARE PERPENDICULAR TO EACH OTHER WITH ±1 DEG.
 - FINE WELDING IS REQUIRED AS PER MENTIONED DETAILS AND FINISHING.
 - HIGHER CURRENT WELDING MAY AFFECT THE BRITTLENESS OF MATERIAL WHICH LATER MAY RAISE TO WEAKENING OF STRUCTURE.
 - FABRICATORS ARE ALLOWED TO USE FITTINGS/FRAMES/SUPPORTS AS NEEDED AND THE SAME MUST BE COMMUNICATED BACK TO ENGINEERING TEAM.
 - BOP COMPONENT WEIGHTS ARE FOR REFERENCE ONLY AND SUBJECTED TO CHANGE PER PURCHASED COMPONENTS.

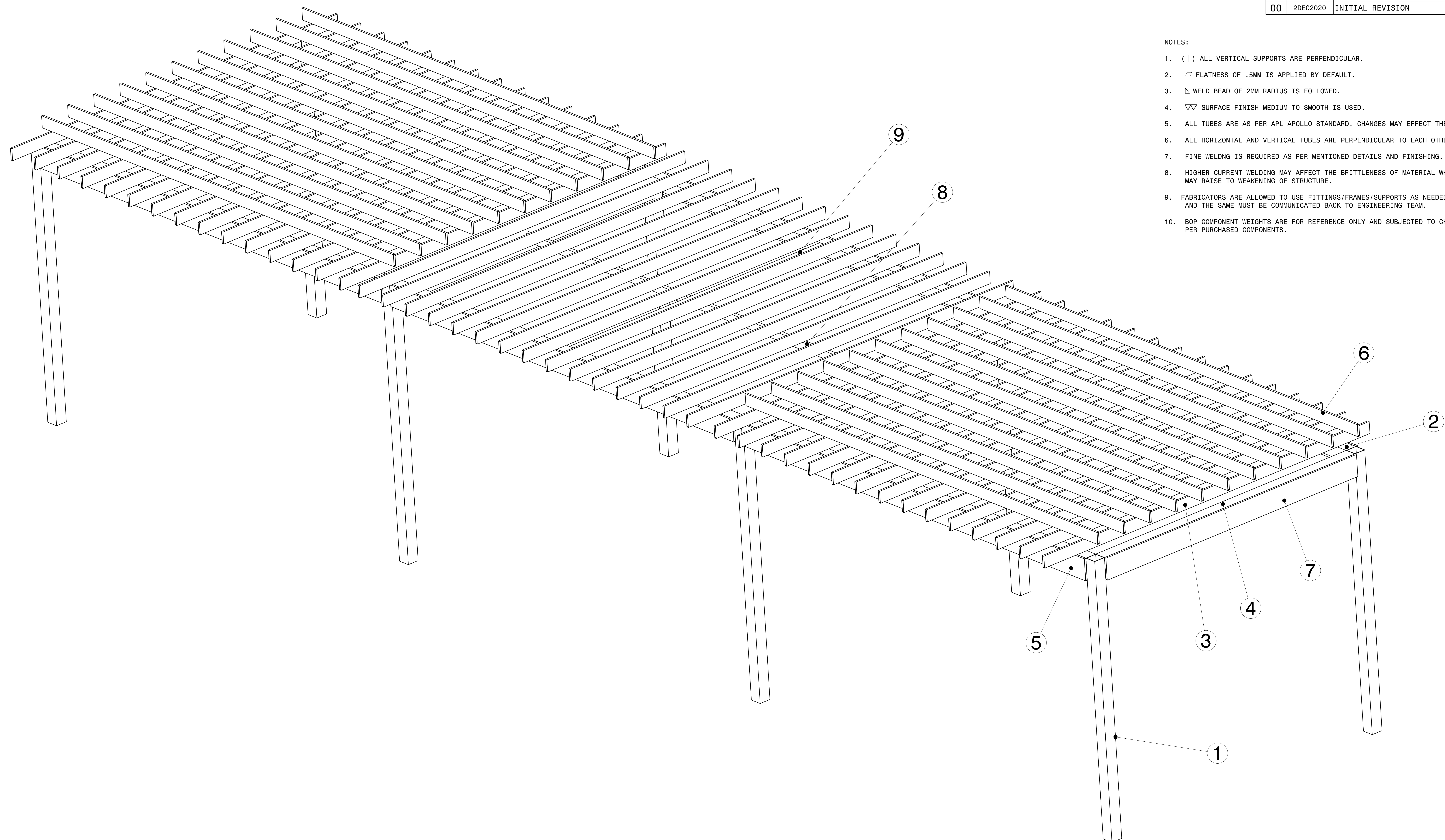

ISOMETRIC VIEW

ITEM NO.	PART NUMBER	DESCRIPTION	QTY.	Wt (kg)/Each
9	RHS FRAME 2	100 X 50 X 3.6 X 3850	1	31.11
8	RHS FRAME 1	100 X 50 X 3.6 X 5825	1	47.07
7	RHS PLANK 4	275 X 25 X 1.6 X 3850	6	28.74
6	RHS PLANK 3	150 X 25 X 1.6 X 6000	22	32.26
5	RHS PLANK 2	275 X 25 X 1.6 X 5850	6	43.67
4	SHS FRAME 3	150 X 150 X 4 X 3850	4	70.69
3	RHS PLANK 1	150 X 25 X 1.6 X 5000	45	21.61
2	SHS FRAME 2	150 X 150 X 4 X 5850	6	107.41
1	SHS FRAME 1	150 X 150 X 4 X 3500	8	64.26

This drawing is our property. It can't be reproduced or communicated without our written agreement.

APL APOLLO TUBES LTD.

DRAWING TITLE: **PATIO DESIGN**

DRAWN BY: VM	DATE: 2DEC2020	SIZE: A0	DRAWING NUMBER: P2P PATIO DESIGN	REV: 00
CHECKED BY: P2P Analysis & Solutions	DATE: 2DEC2020	SCALE: As Indicated	WEIGHT(kg): 0kg	SHEET 1 OF 3
DESIGNED BY: P2P Analysis & Solutions	DATE: 2DEC2020			

UNLESS OTHERWISE SPECIFIED DIMENSION ARE IN MM
 VIEWS: THIRD ANGLE PROJECTION

REV	DATE	DESCRIPTION
00	2DEC2020	INITIAL REVISION

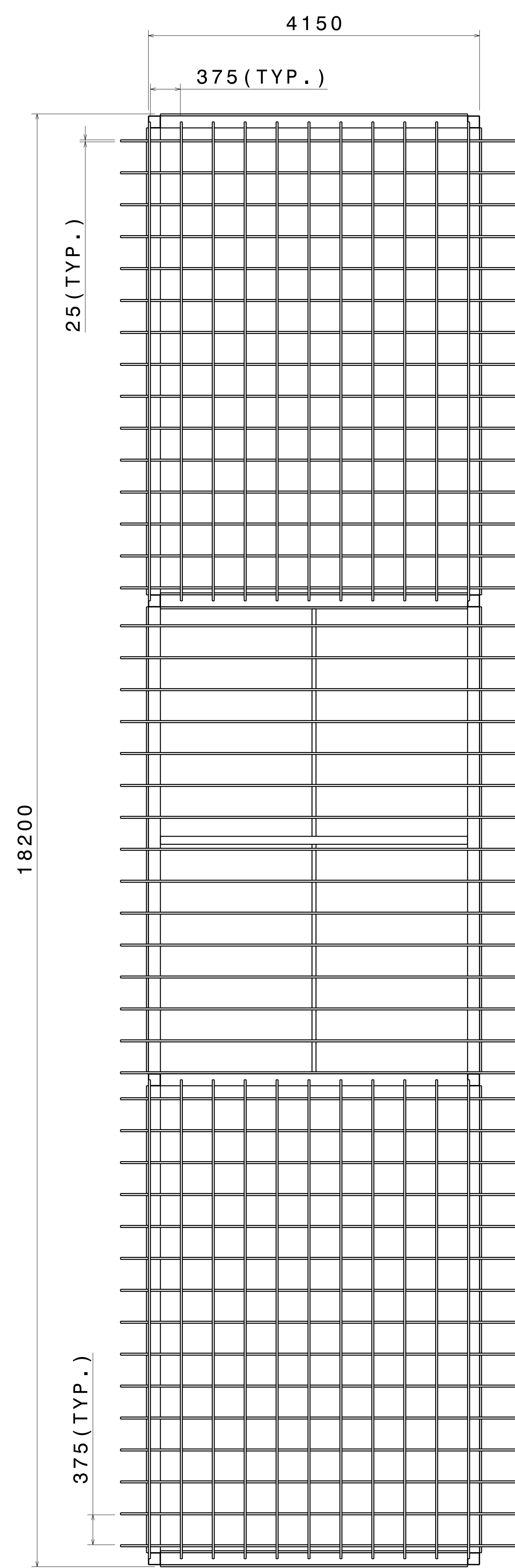

FRONT VIEW

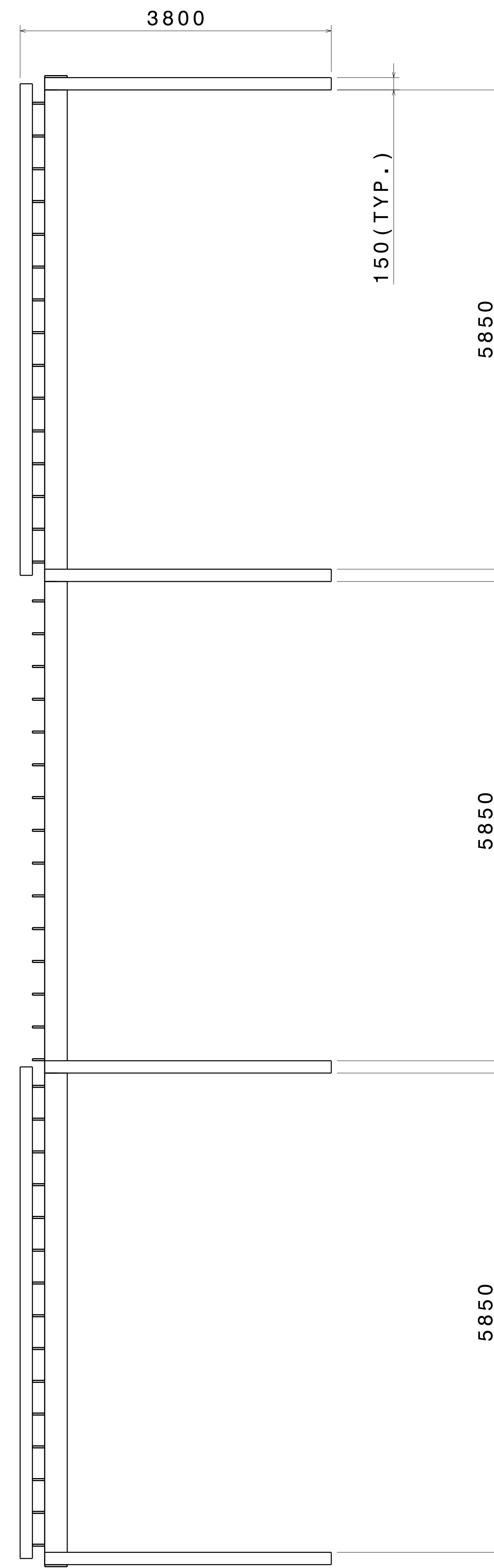

RIGHT VIEW

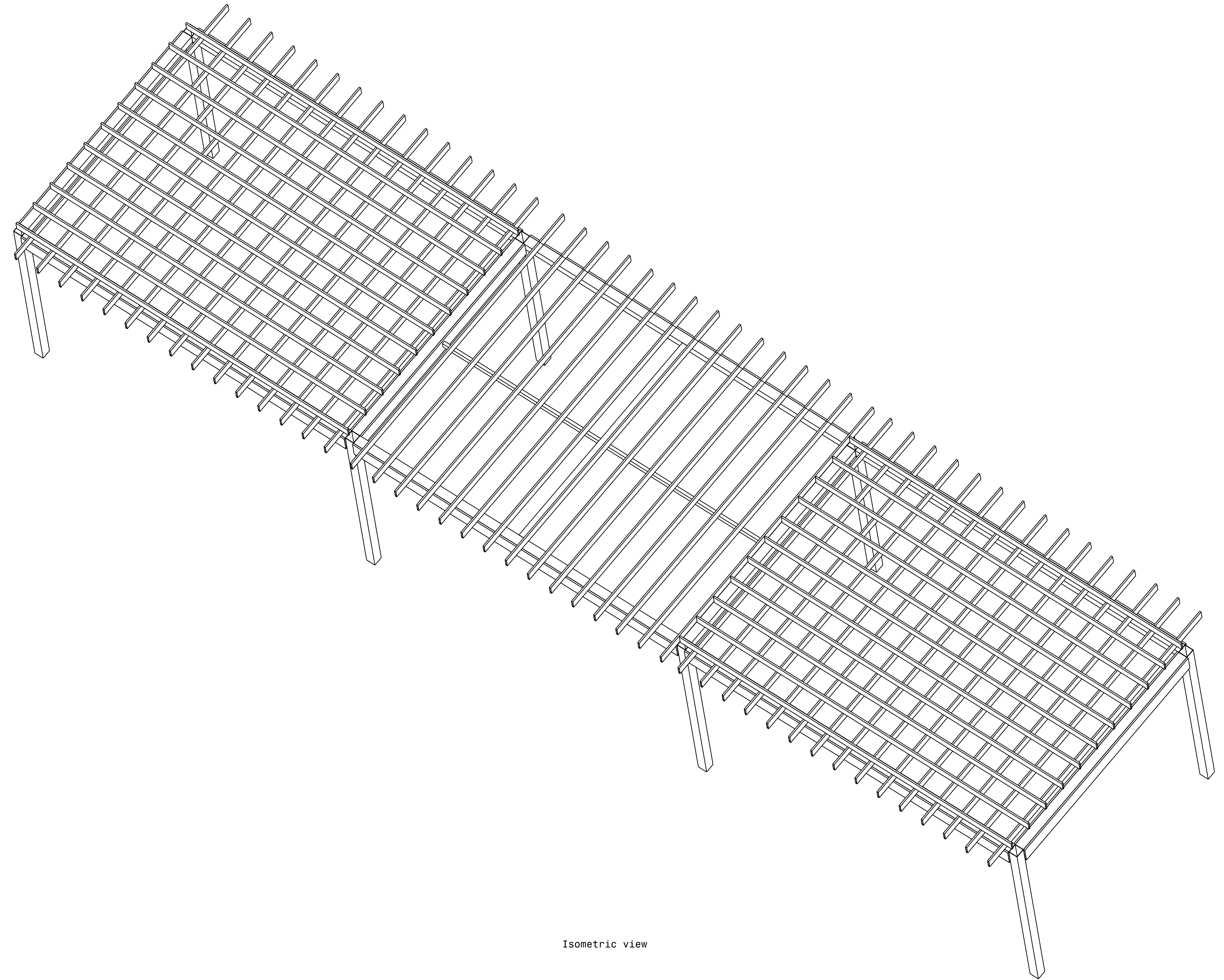

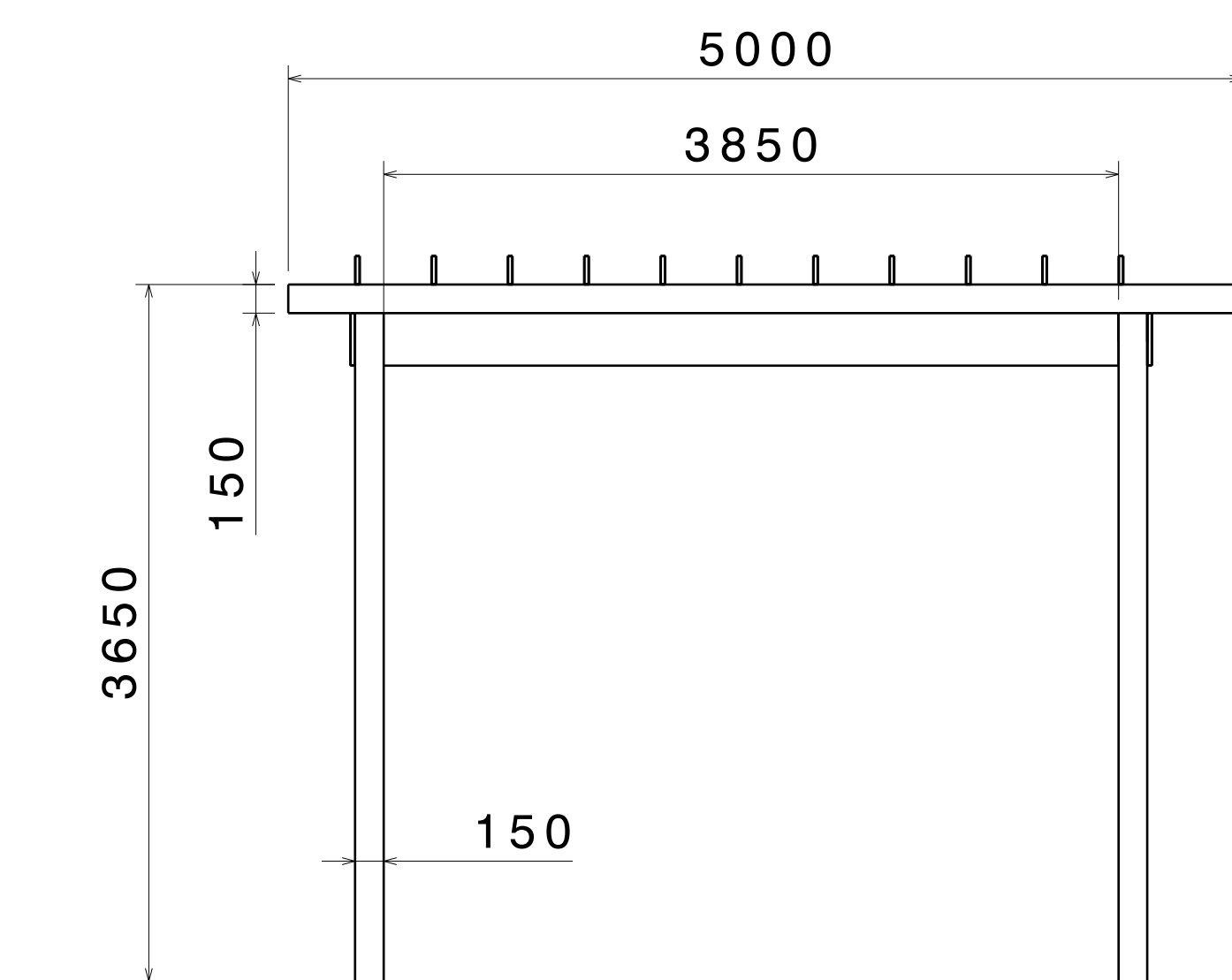

Isometric view

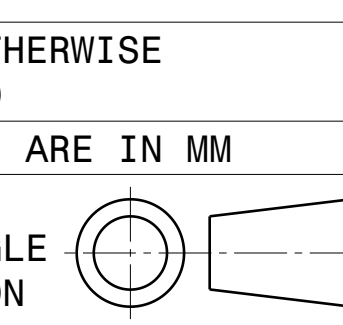

BOTTOM VIEW

UNLESS OTHERWISE SPECIFIED DIMENSION ARE IN MM VIEWS: THIRD ANGLE PROJECTION



This drawing is our property. It can't be reproduced or communicated without our written agreement.		APL APOLLO TUBES LTD. 	
DRAWN BY SB		DRAWING TITLE PATIO DESIGN	
CHECKED BY P2P Analysis & Solutions	DATE 2DEC2020	SIZE A0	DRAWING NUMBER P2P PATIO DESIGN
DESIGNED BY P2P Analysis & Solutions	DATE 2DEC2020	SCALE NONE	WEIGHT (kg) XXX
			SHEET 2 OF 3

REV	DATE	DESCRIPTION
00	2DEC2020	INITIAL REVISION

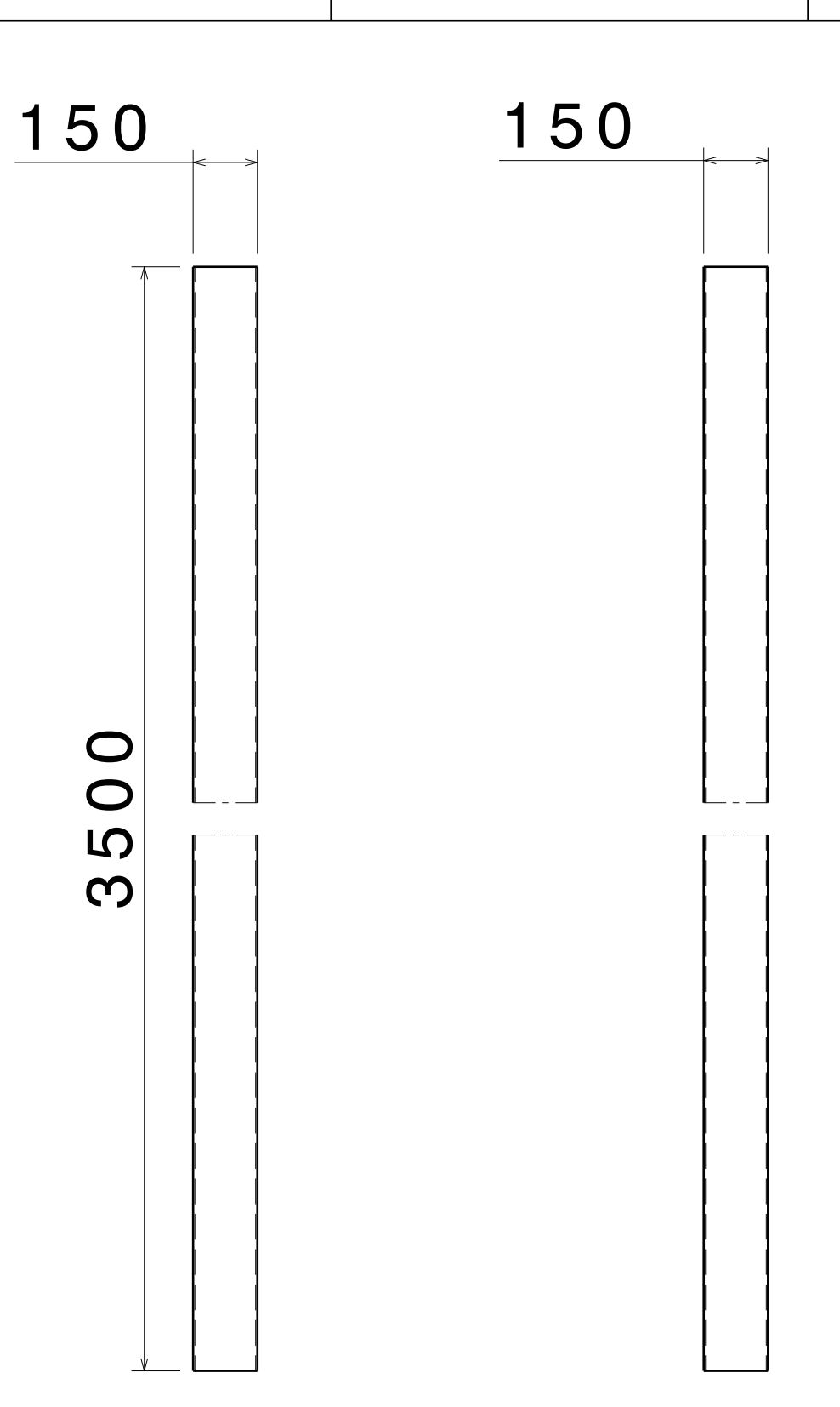

FRONT VIEW RIGHT VIEW
SCALE: 1:15 SCALE: 1:15
ITEM 1, SHS FRAME 1
THICKNESS - 4.0MM

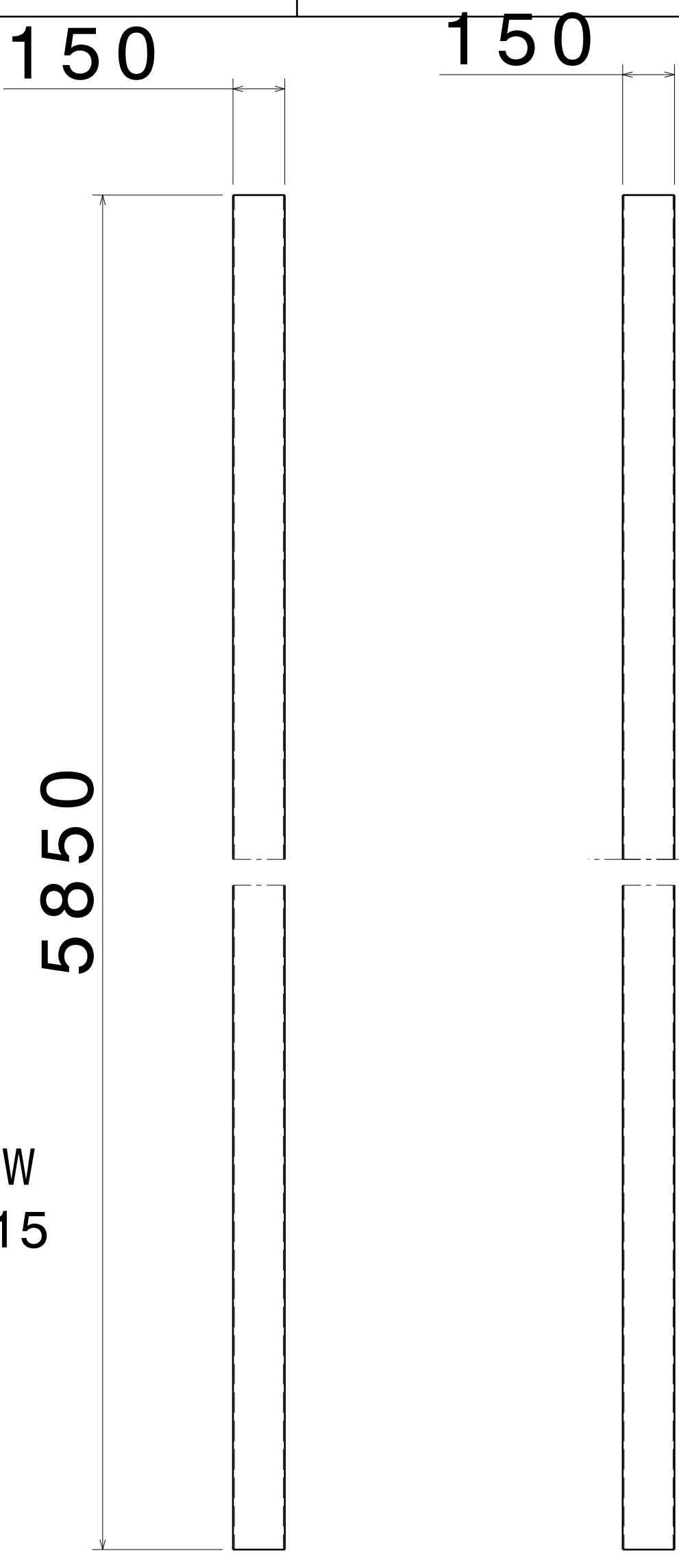

FRONT VIEW RIGHT VIEW
SCALE: 1:15 SCALE: 1:15
ITEM 2, SHS FRAME 2
THICKNESS - 4.0 MM

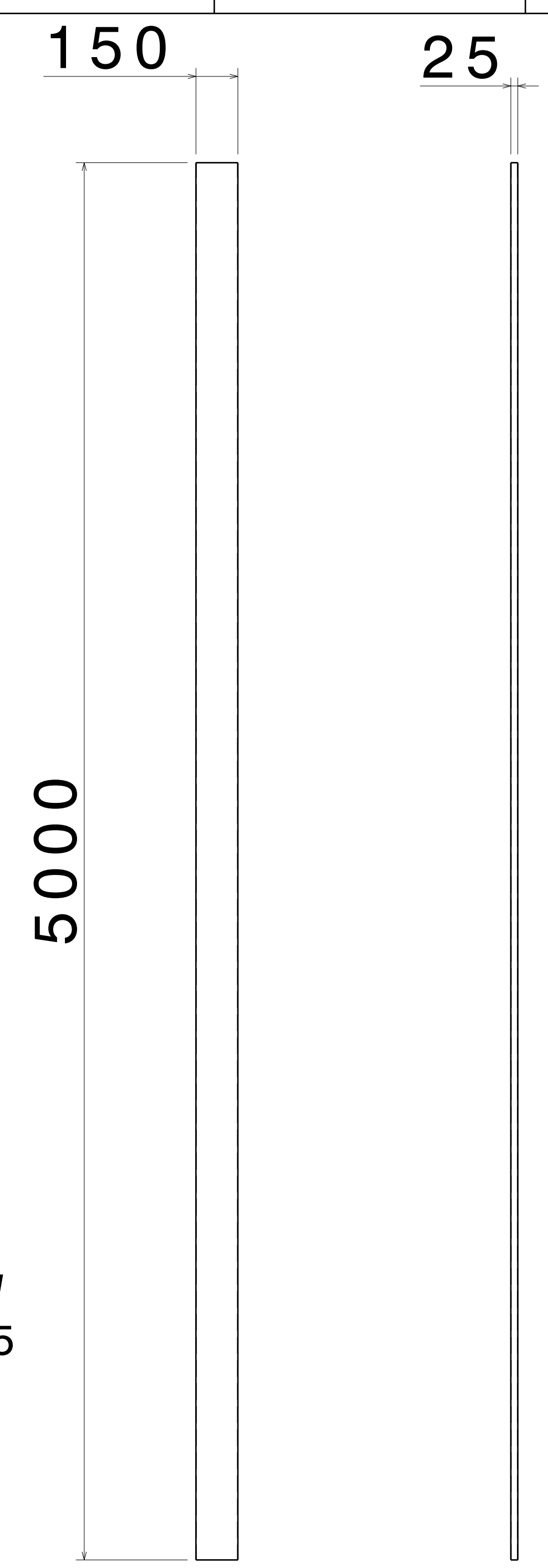

FRONT VIEW RIGHT VIEW
SCALE: 1:15 SCALE: 1:15
ITEM 3, RHS PLANK 1
THICKNESS -1.6 MM

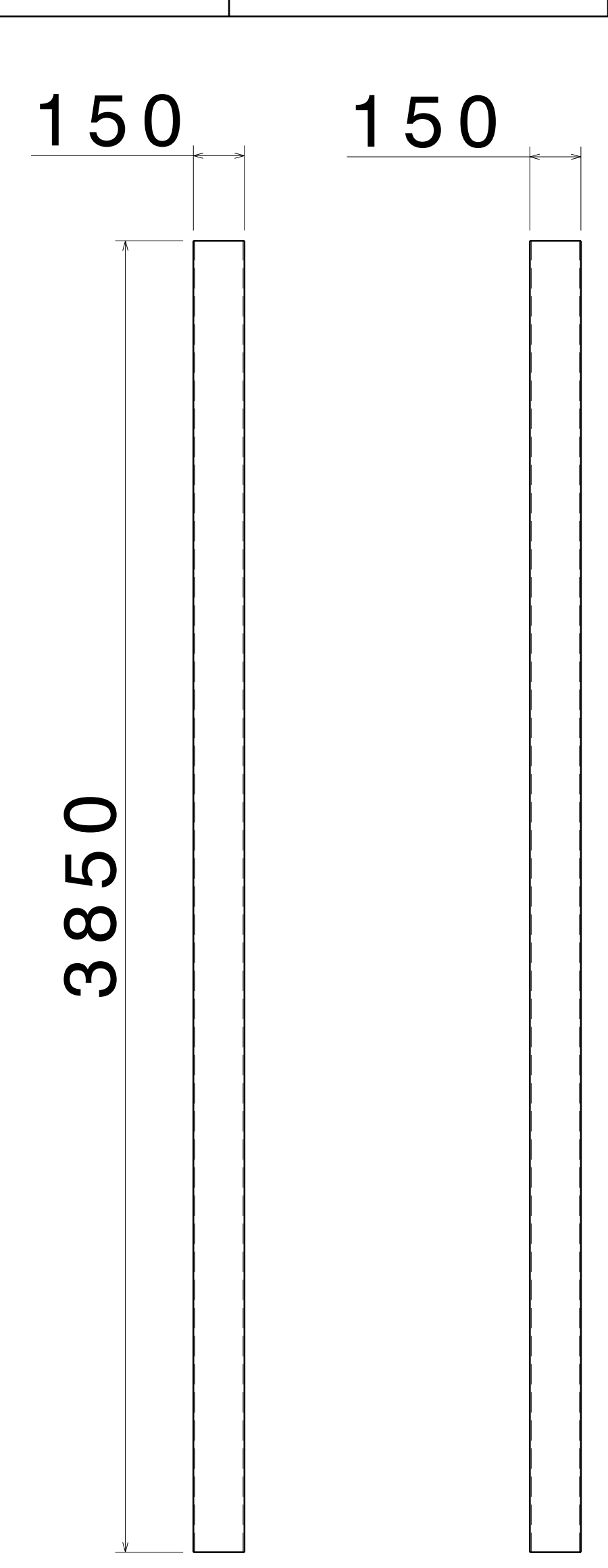

FRONT VIEW RIGHT VIEW
SCALE: 1:15 SCALE: 1:15
ITEM 4, SHS FRAME 3
THICKNESS - 4.0 MM

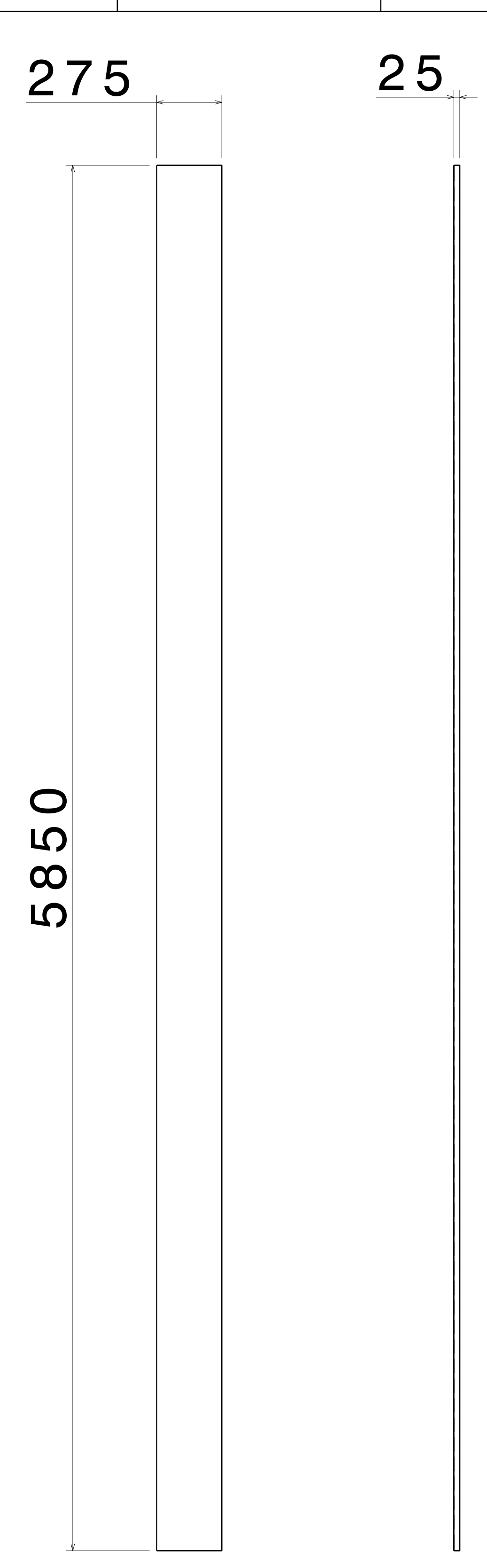

FRONT VIEW RIGHT VIEW
SCALE: 1:15 SCALE: 1:15
ITEM 5, RHS PLANK 2
THICKNESS -1.6 MM

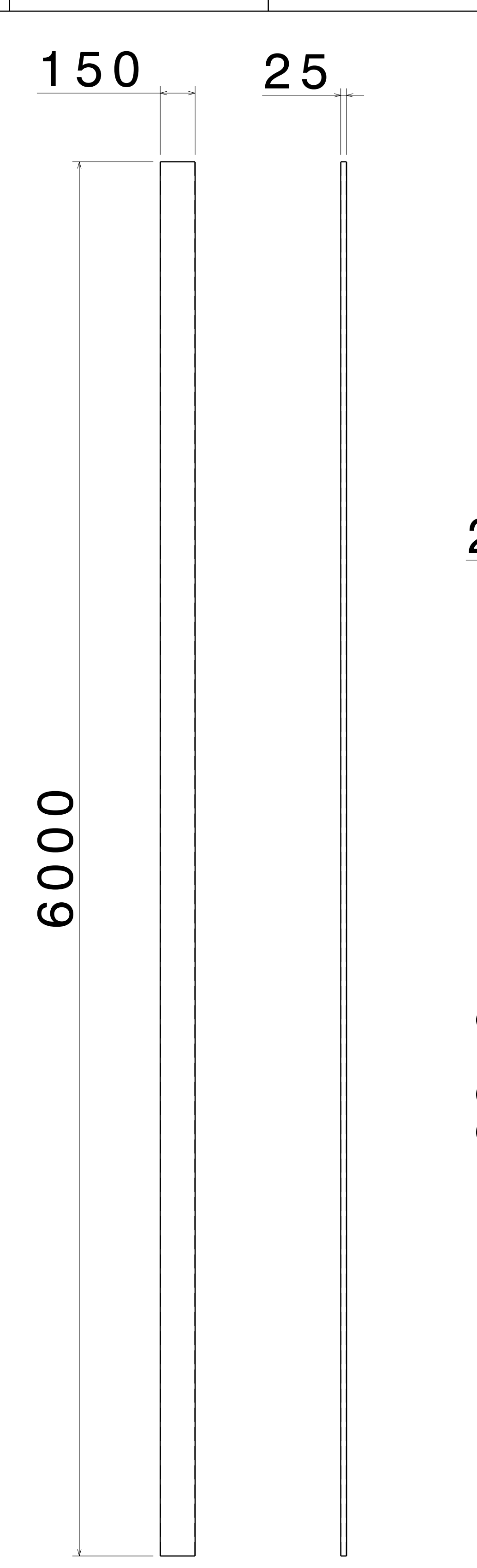

FRONT VIEW RIGHT VIEW
SCALE: 1:15 SCALE: 1:15
ITEM 6, RHS PLANK 3
THICKNESS -1.6 MM

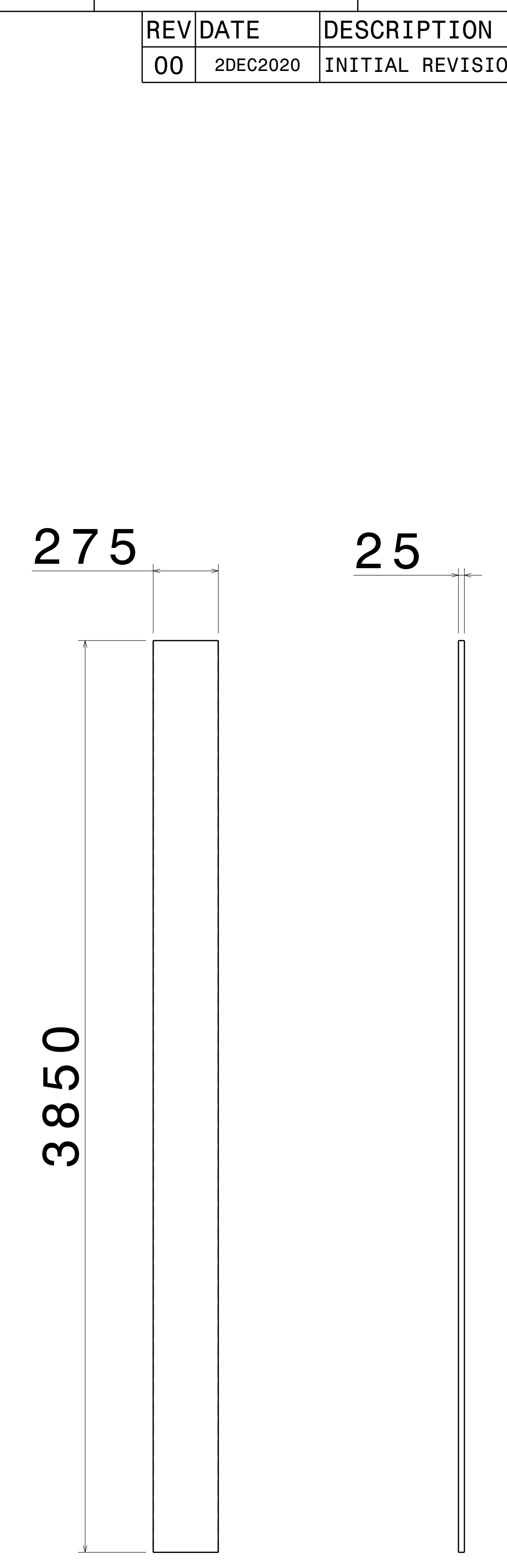

FRONT VIEW RIGHT VIEW
SCALE: 1:15 SCALE: 1:15
ITEM 7, RHS PLANK 4
THICKNESS -1.6 MM

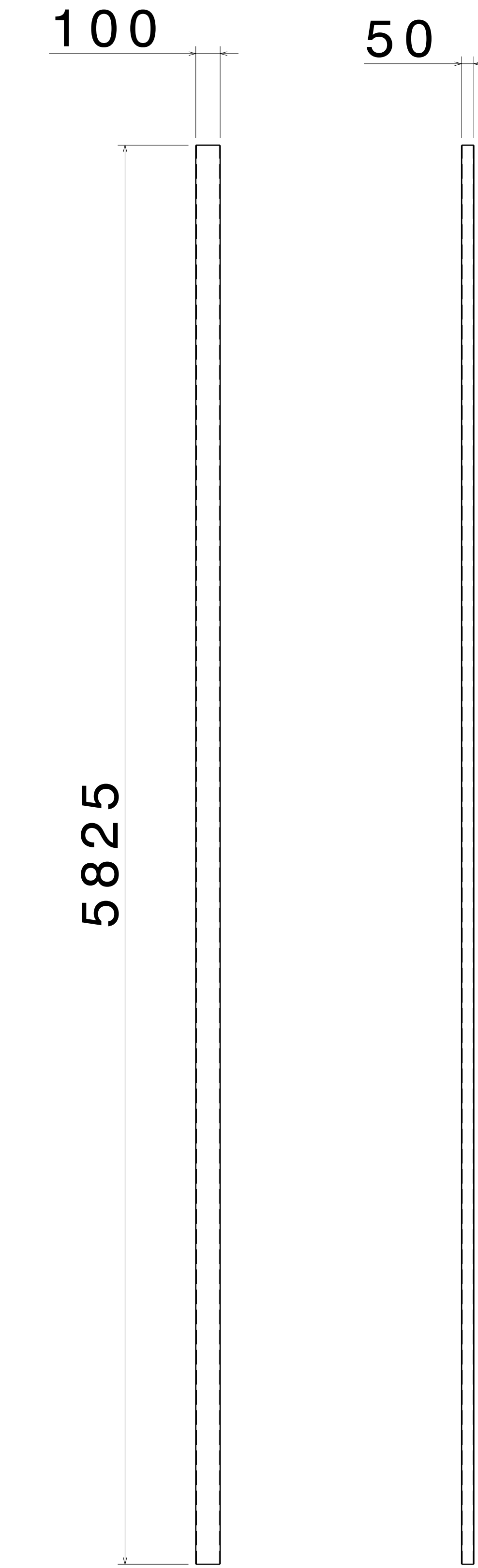

FRONT VIEW RIGHT VIEW
SCALE: 1:15 SCALE: 1:15
ITEM 8, RHS FRAME 1
THICKNESS -3.6 MM

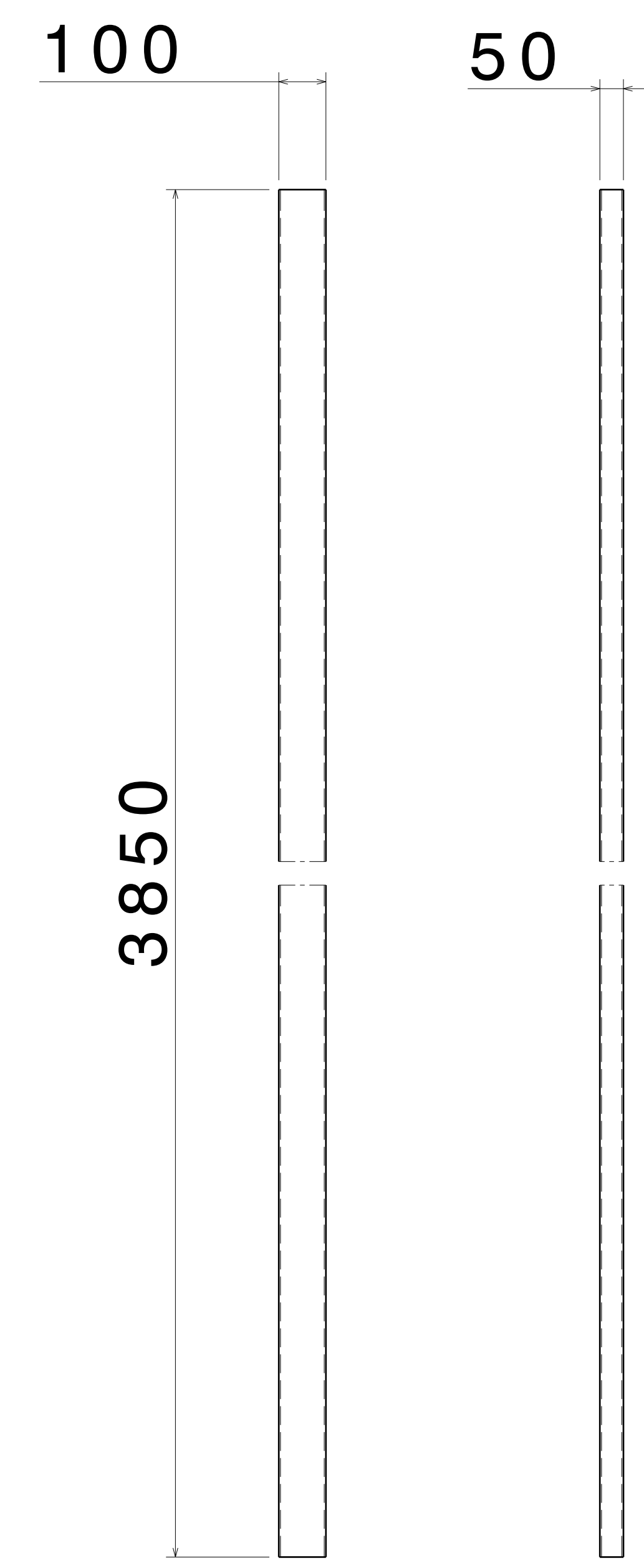

FRONT VIEW RIGHT VIEW
SCALE: 1:15 SCALE: 1:15
ITEM 9, RHS FRAME 2
THICKNESS -3.6 MM

UNLESS OTHERWISE SPECIFIED DIMENSION ARE IN MM
VIEWS: THIRD ANGLE PROJECTION

This drawing is our property. It can't be reproduced or communicated without our written agreement.		APL APOLLO TUBES LTD.	
DRAWN BY SB		DRAWING TITLE PATIO DESIGN	
CHECKED BY P2P Analysis & Solutions	DATE 2DEC2020	SIZE A0	DRAWING NUMBER P2P PATIO DESIGN
DESIGNED BY P2P Analysis & Solutions	DATE 2DEC2020	SCALE NONE	WEIGHT (kg) XXX
		SHEET 3 OF 3	