

REV/DATE	DESCRIPTION
00 / 15FEB2021	INITIAL REVISION

- NOTES:
- (⊥) ALL VERTICAL SUPPORTS ARE PERPENDICULAR.
  - FLATNESS OF .5MM IS APPLIED BY DEFAULT.
  - ⊲ WELD BEAD OF 2MM RADIUS IS FOLLOWED.
  - ▽▽ SURFACE FINISH MEDIUM TO SMOOTH IS USED.
  - ALL TUBES ARE AS PER APL APOLLO STANDARD. CHANGES MAY EFFECT THE LOAD CAPACITY.
  - ALL HORIZONTAL AND VERTICAL TUBES ARE PERPENDICULAR TO EACH OTHER WITH ±1 DEG.
  - FINE WELDING IS REQUIRED AS PER MENTIONED DETAILS AND FINISHING.
  - HIGHER CURRENT WELDING MAY AFFECT THE BRITTLNESS OF MATERIAL WHICH LATER MAY RAISE TO WEAKENING OF STRUCTURE.
  - FABRICATORS ARE ALLOWED TO USE FITTINGS/FRAMES/SUPPORTS AS NEEDED AND THE SAME MUST BE COMMUNICATED BACK TO ENGINEERING TEAM.
  - BOP COMPONENT WEIGHTS ARE FOR REFERENCE ONLY AND SUBJECTED TO CHANGE PER PURCHASED COMPONENTS.

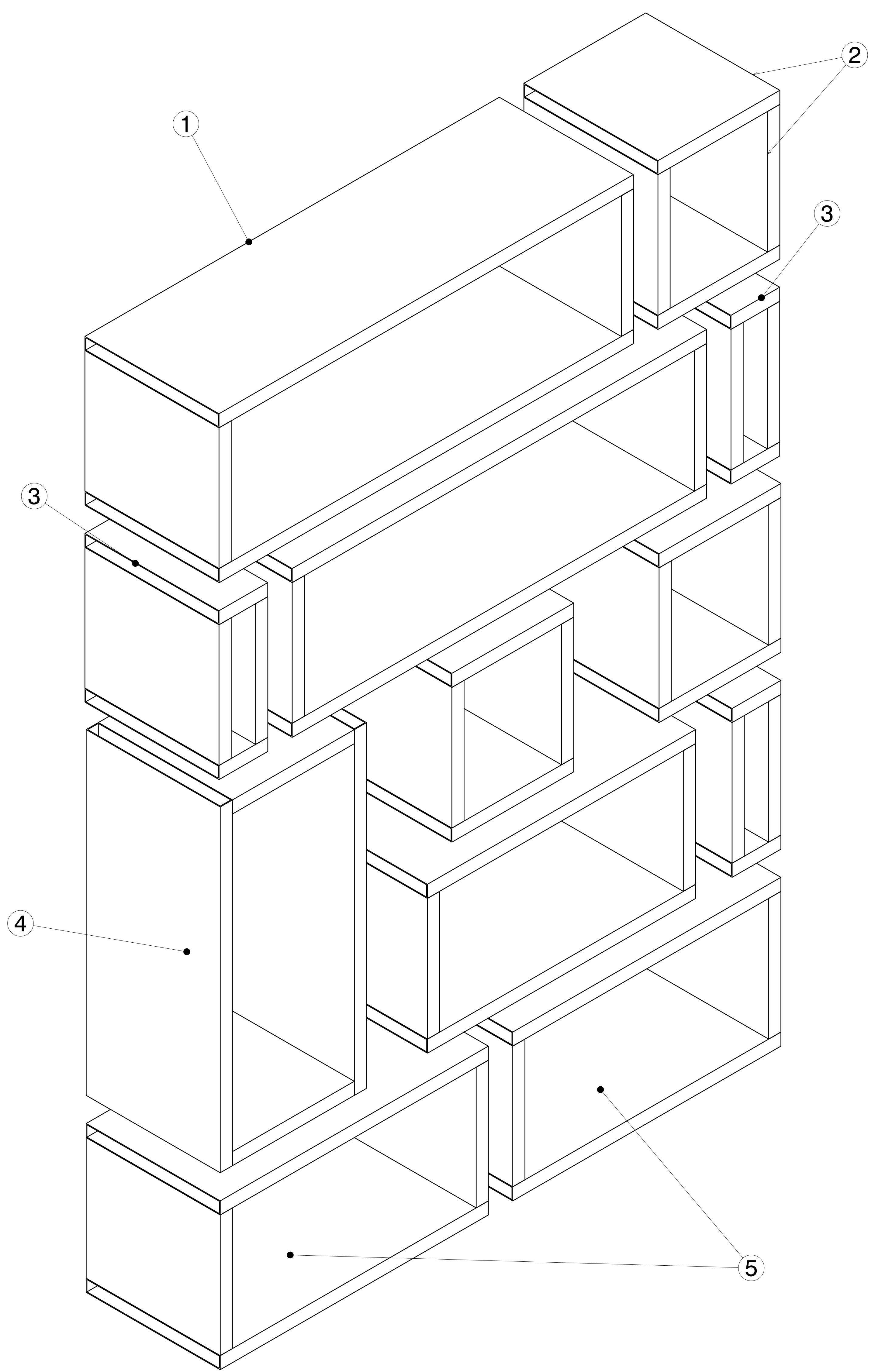

Isometric view 1

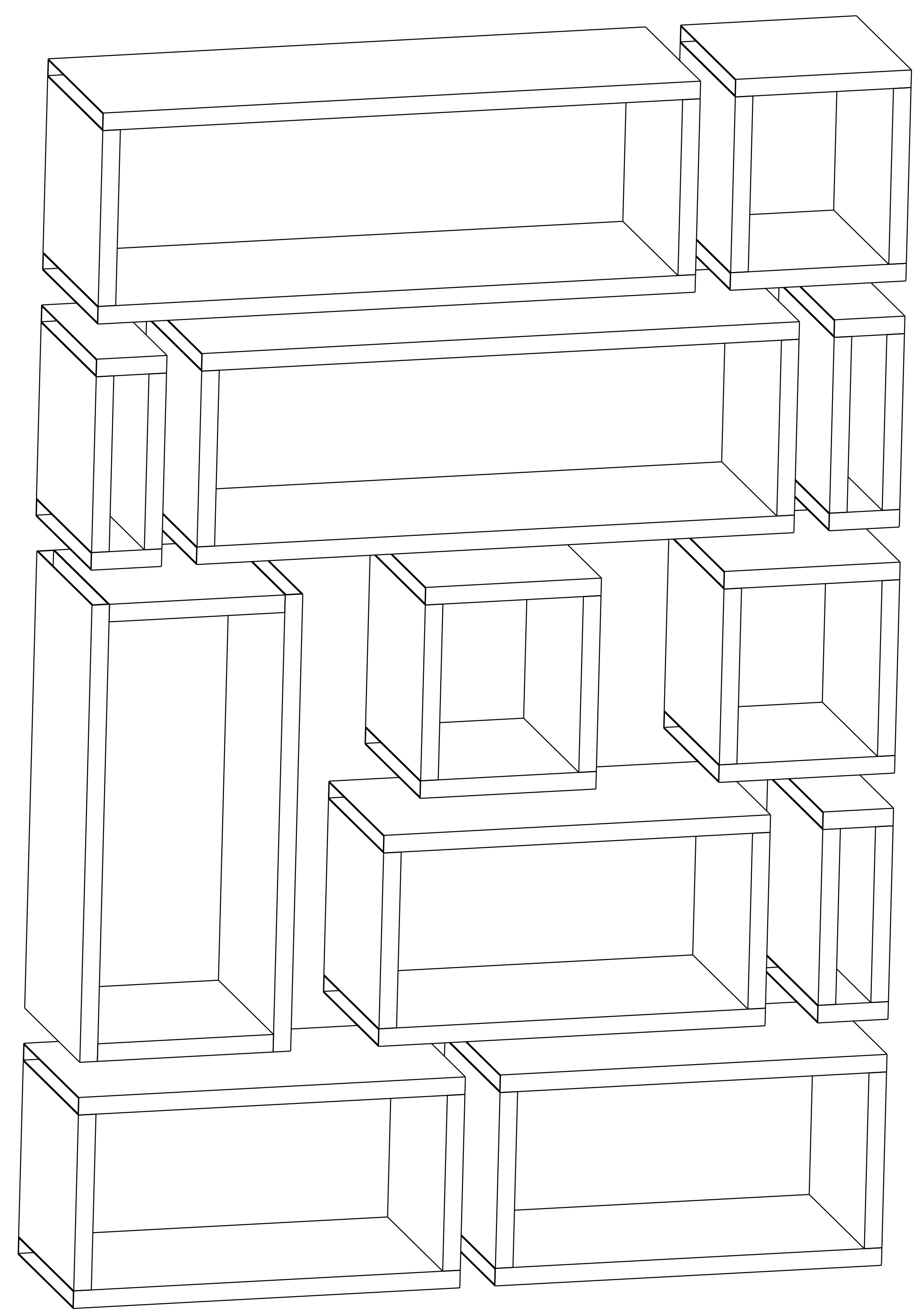

Isometric view 2

ITEM NO.	PART NUMBER	DESCRIPTION	QTY.	Wt (kg)/Each
5	PLANK 5	275 X 25 X 1.6 X 550	6	4.1
4	PLANK 4	275 X 25 X 1.6 X 650	2	4.85
3	PLANK 3	275 X 25 X 1.6 X 100	6	0.94
2	PLANK 2	275 X 25 X 1.6 X 200	30	1.87
1	PLANK 1	275 X 25 X 1.6 X 850	4	6.35

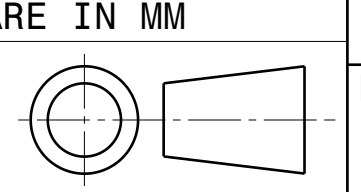
This drawing is our property. It can't be reproduced or communicated without our written agreement.		APL APOLLO TUBES LTD. 	
DRAWN BY SB		DATE 15FEB2021	
CHECKED BY P2P Analysis & Solutions		DATE 15FEB2021	
DESIGNED BY P2P Analysis & Solutions		DATE 15FEB2021	
DRAWING TITLE SHELF		SIZE A0	DRAWING NUMBER P2P FEB 21-06
UNLESS OTHERWISE SPECIFIED DIMENSION ARE IN MM		SCALE As Indicated	WEIGHT (kg) 0kg
VIEWS: THIRD ANGLE PROJECTION 		REV 00	
		SHEET 1 OF 3	

UNLESS OTHERWISE SPECIFIED DIMENSION ARE IN MM

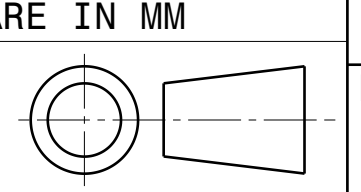
VIEWS:  
THIRD ANGLE PROJECTION 

REV	DATE	DESCRIPTION
00	15FEB2021	INITIAL REVISION

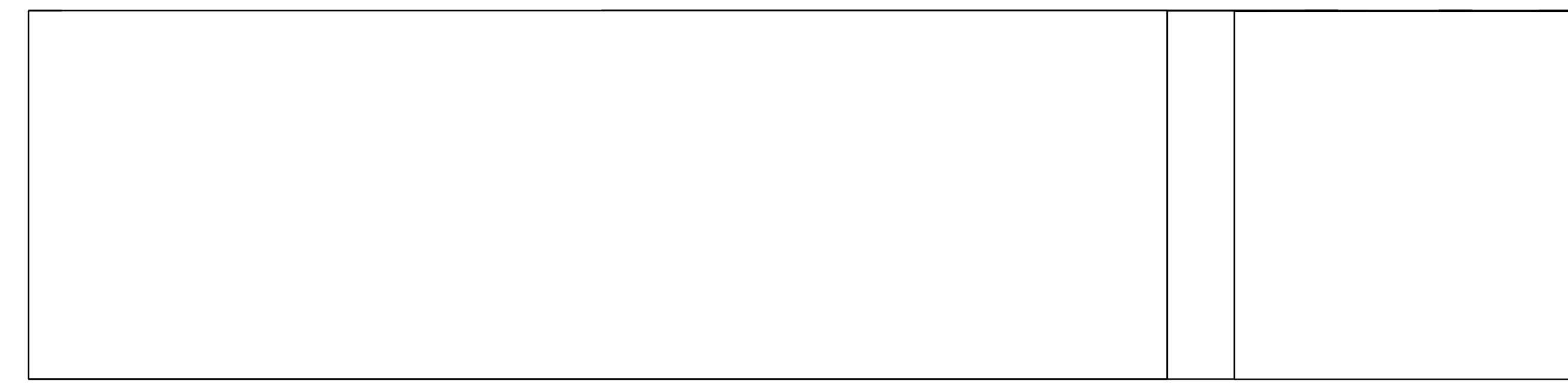

Top view  
Scale: 3:10

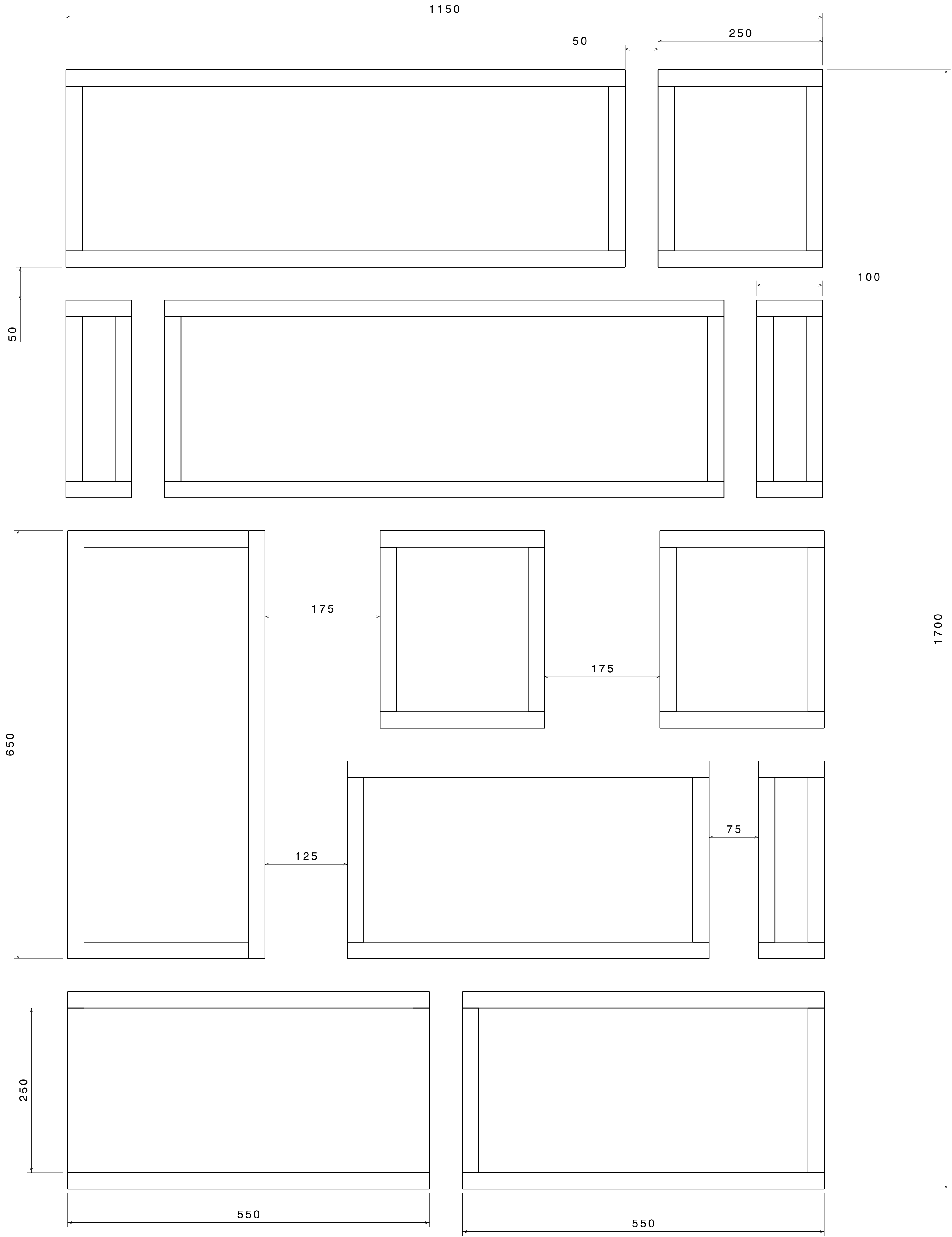

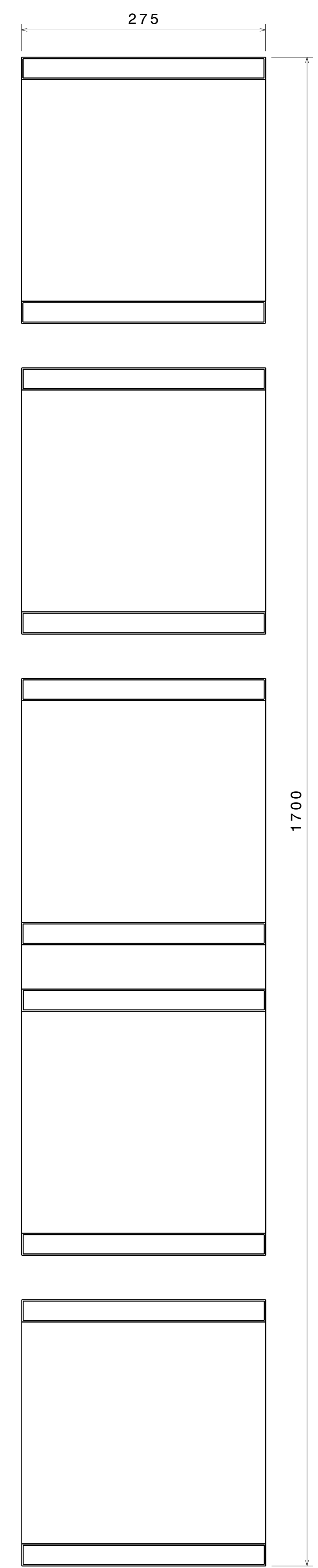

Front view  
Scale: 3:10

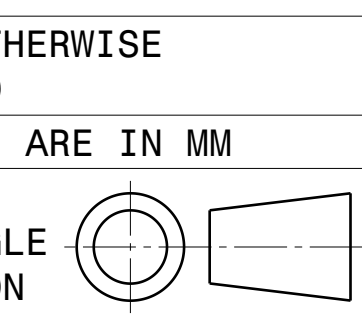

Right view  
Scale: 3:10

UNLESS OTHERWISE SPECIFIED DIMENSION ARE IN MM  
VIEWS: THIRD ANGLE PROJECTION



This drawing is our property. It can't be reproduced or communicated without our written agreement.		APL APOLLO TUBES LTD. 	
DRAWN BY SB		DATE 15FEB2021	
CHECKED BY P2P Analysis & Solutions		DATE 15FEB2021	
DESIGNED BY P2P Analysis & Solutions		DATE 15FEB2021	
SIZE A0	DRAWING NUMBER P2P FEB 21-06		REV 00
SCALE NONE	WEIGHT (kg) XXX	SHEET 2 OF 3	

DRAWING TITLE  
**SHELF**

REV	DATE	DESCRIPTION
00	15FEB2021	INITIAL REVISION

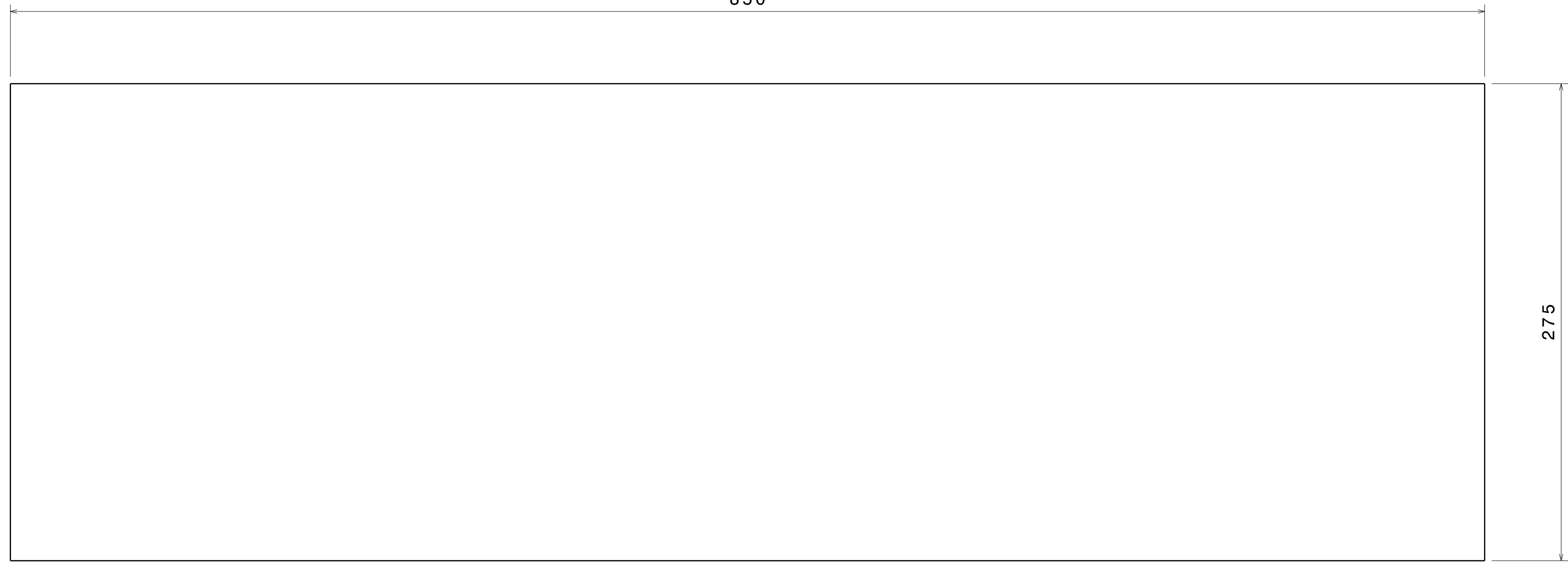

ITEM 1

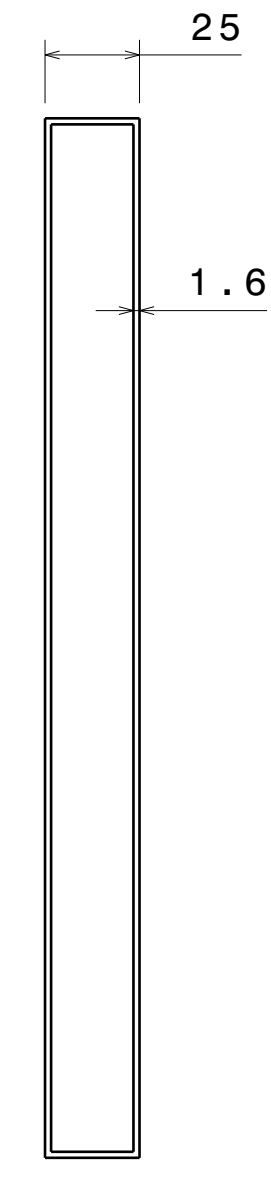

Right view  
Scale: 1:2

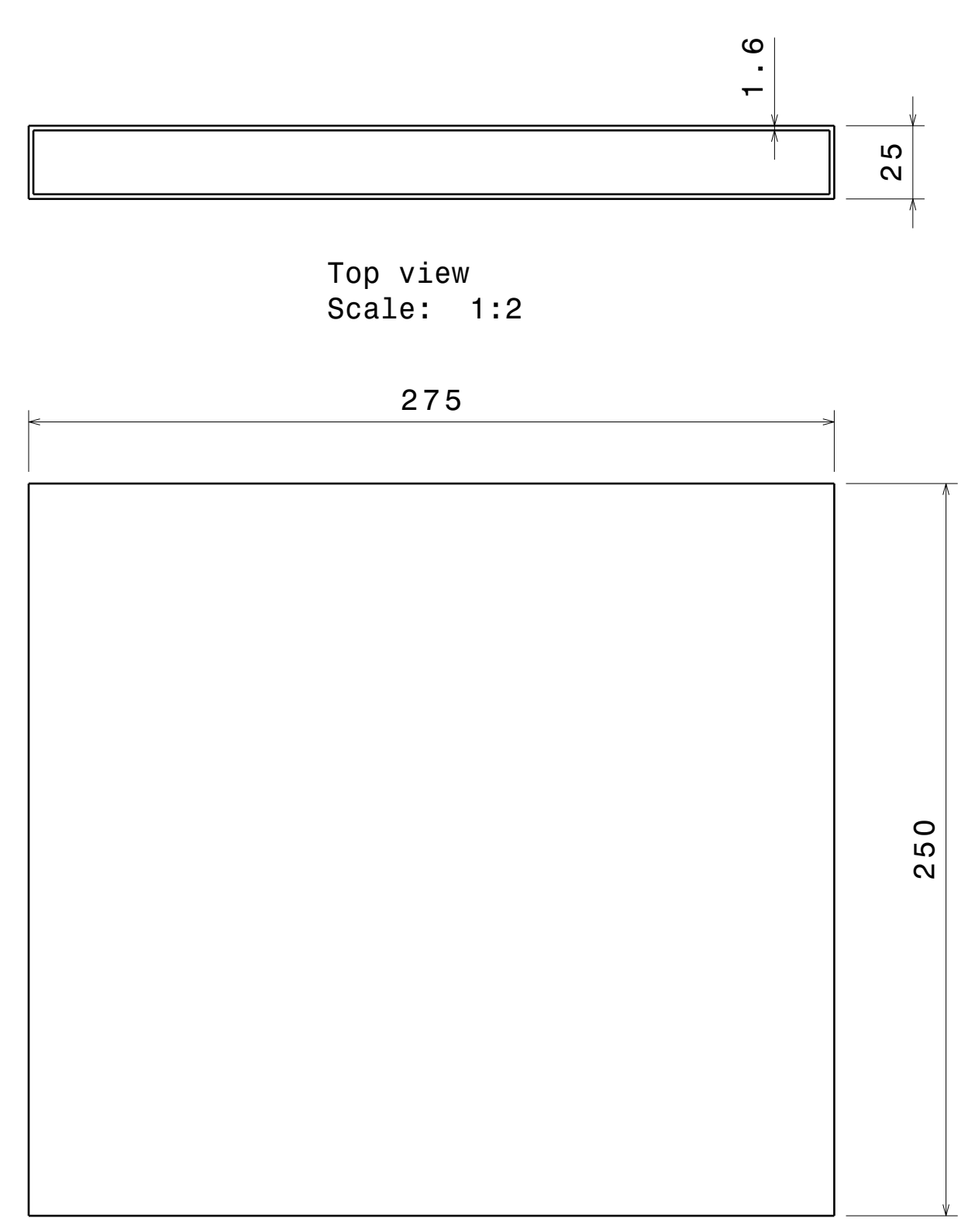

Top view  
Scale: 1:2

ITEM 2

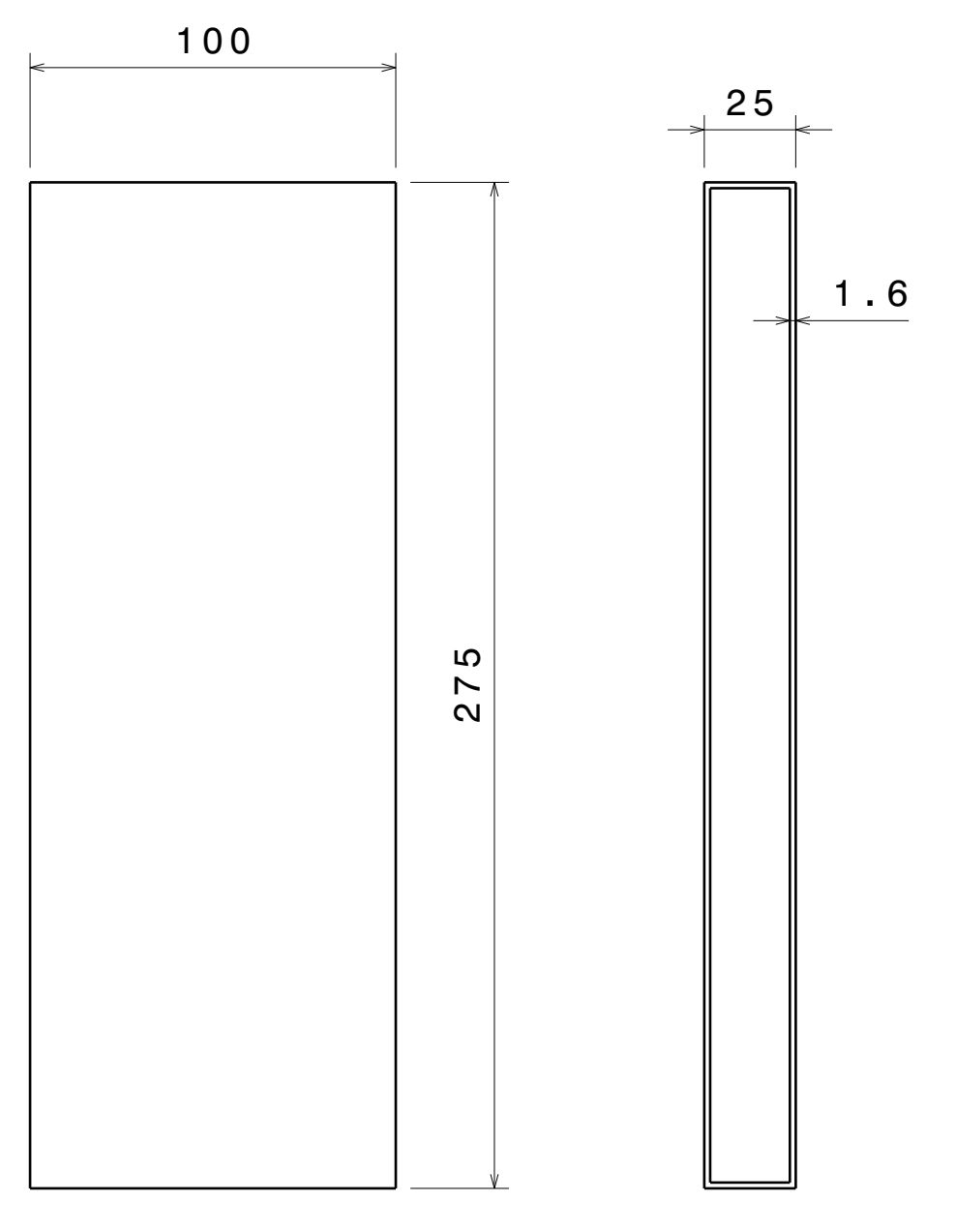

ITEM 3

Right view  
Scale: 1:2



ITEM 4

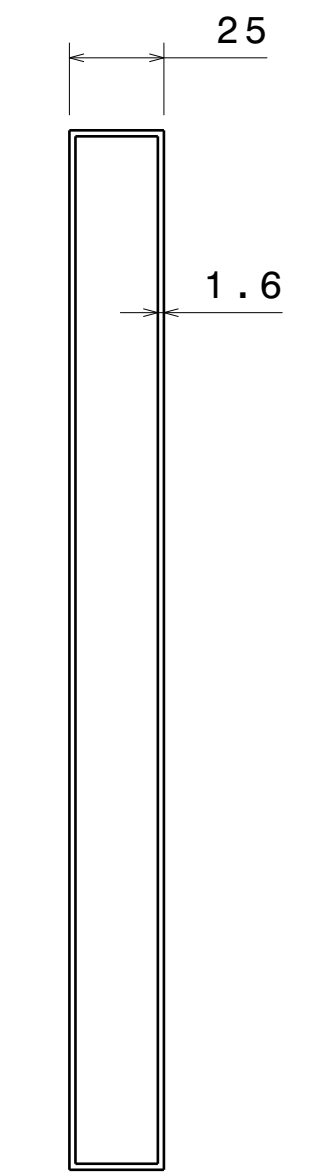

Right view  
Scale: 1:2



ITEM 5

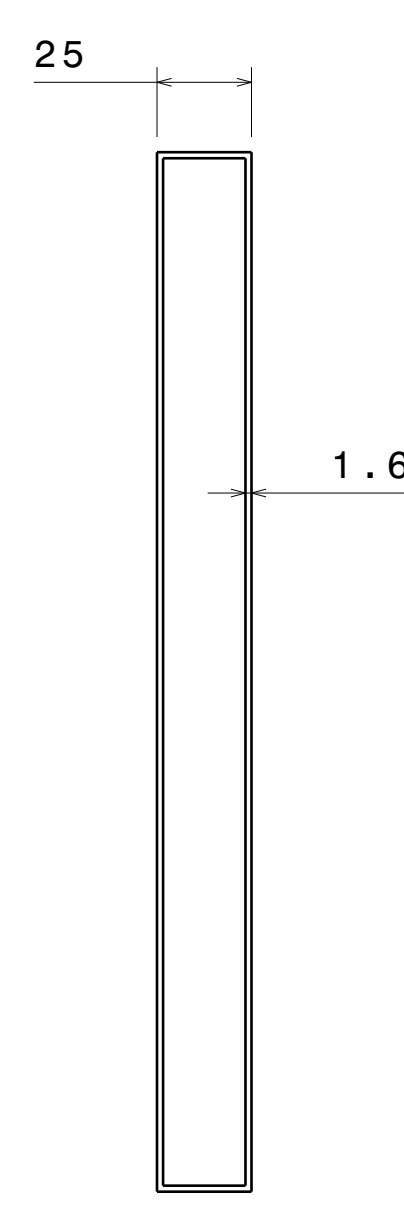

Right view  
Scale: 1:2

UNLESS OTHERWISE SPECIFIED DIMENSION ARE IN MM  
VIEWS: THIRD ANGLE PROJECTION

This drawing is our property. It can't be reproduced or communicated without our written agreement.		APL APOLLO TUBES LTD.	
DRAWN BY SB		DATE 15FEB2021	
CHECKED BY P2P Analysis & Solutions		DATE 15FEB2021	
DESIGNED BY P2P Analysis & Solutions		DATE 15FEB2021	
SIZE A0	DRAWING NUMBER P2P FEB 21-06		REV 00
SCALE NONE	WEIGHT (kg) XXX	SHEET 3 OF 3	

DRAWING TITLE  
SHELF