

REV	DATE	DESCRIPTION
00	20FEB2021	INITIAL REVISION

- NOTES:
- (⊥) ALL VERTICAL SUPPORTS ARE PERPENDICULAR.
  - FLATNESS OF .5MM IS APPLIED BY DEFAULT.
  - ⊥ WELD BEAD OF 2MM RADIUS IS FOLLOWED.
  - ▽▽ SURFACE FINISH MEDIUM TO SMOOTH IS USED.
  - ALL TUBES ARE AS PER APL APOLLO STANDARD. CHANGES MAY EFFECT THE LOAD CAPACITY.
  - ALL HORIZONTAL AND VERTICAL TUBES ARE PERPENDICULAR TO EACH OTHER WITH ±1 DEG.
  - FINE WELDING IS REQUIRED AS PER MENTIONED DETAILS AND FINISHING.
  - HIGHER CURRENT WELDING MAY AFFECT THE BRITTLENESS OF MATERIAL WHICH LATER MAY RAISE TO WEAKENING OF STRUCTURE.
  - FABRICATORS ARE ALLOWED TO USE FITTINGS/FRAMES/SUPPORTS AS NEEDED AND THE SAME MUST BE COMMUNICATED BACK TO ENGINEERING TEAM.
  - BOP COMPONENT WEIGHTS ARE FOR REFERENCE ONLY AND SUBJECTED TO CHANGE PER PURCHASED COMPONENTS.

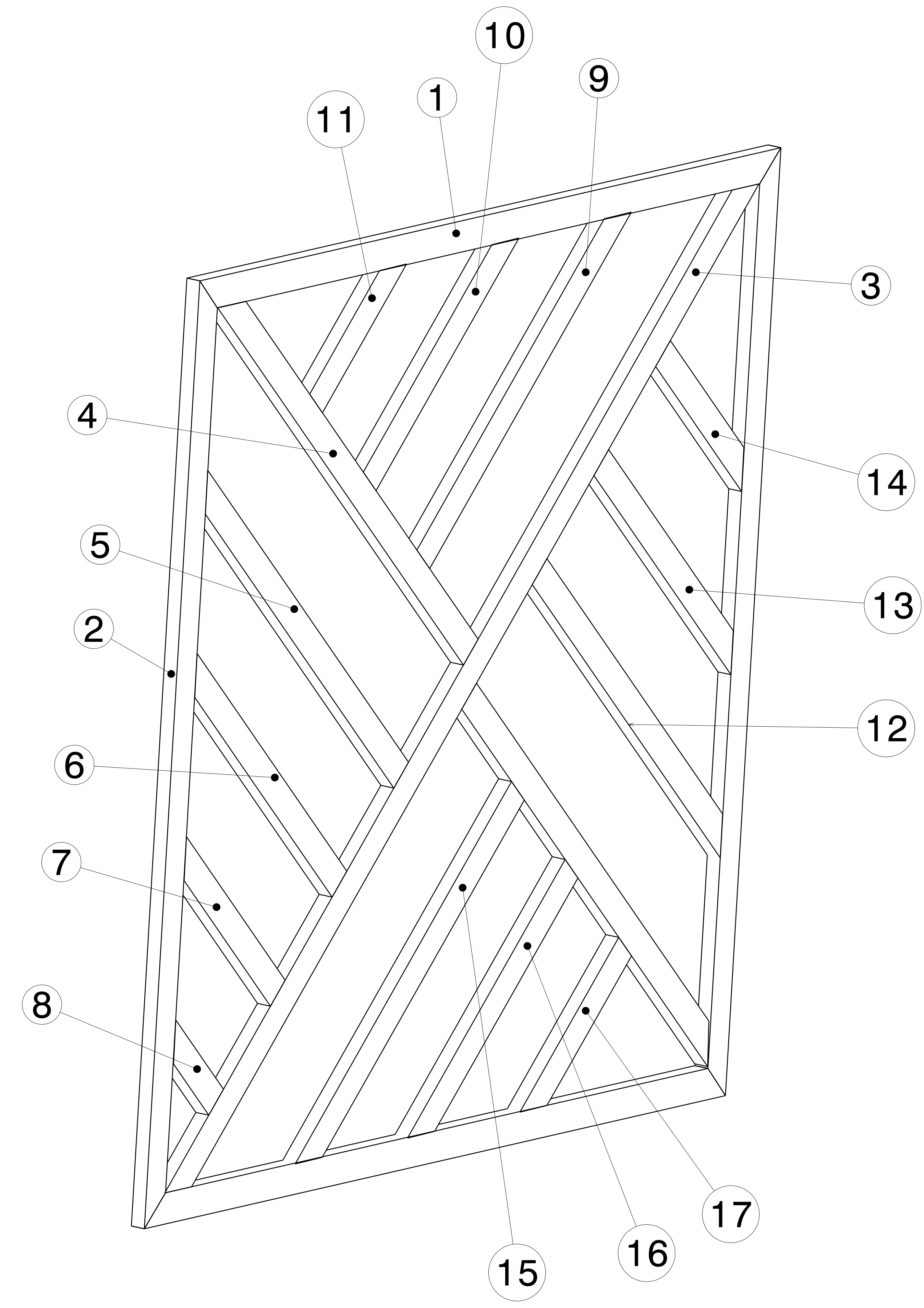

Isometric view  
Scale: 1:4

ITEM NO.	PART NUMBER	DESCRIPTION	QTY.	Wt (Kg)/Each
17	RHS FRAME 17	50 X 25 X 2 X 337	1	0.60
16	RHS FRAME 16	50 X 25 X 2 X 537	1	1.0
15	RHS FRAME 15	50 X 25 X 2 X 737	1	1.50
14	RHS FRAME 14	50 X 25 X 2 X 337	1	0.60
13	RHS FRAME 13	50 X 25 X 2 X 537	1	1.0
12	RHS FRAME 12	50 X 25 X 2 X 737	1	0.70
11	RHS FRAME 11	50 X 25 X 2 X 287	1	0.55
10	RHS FRAME 10	50 X 25 X 2 X 487	1	0.65
9	RHS FRAME 9	50 X 25 X 2 X 687	1	0.20
8	RHS FRAME 8	50 X 25 X 2 X 187	1	0.25
7	RHS FRAME 7	50 X 25 X 2 X 387	1	0.75
6	RHS FRAME 6	50 X 25 X 2 X 587	1	0.25
5	RHS FRAME 5	50 X 25 X 2 X 787	1	0.25
4	RHS FRAME 4	50 X 25 X 2 X 964	2	2.25
3	RHS FRAME 3	50 X 25 X 2 X 1950	1	2.5
2	RHS FRAME 2	50 X 25 X 2 X 1500	2	3.20
1	RHS FRAME 1	50 X 25 X 2 X 1500	2	3.20

This drawing is our property. It can't be reproduced or communicated without our written agreement.		APL APOLLO TUBES LTD.	
DRAWING TITLE			
WINDOW			
DRAWN BY	DATE	SIZE	DRAWING NUMBER
RR	20FEB2021	A0	P2P FEB 21-10
CHECKED BY	DATE	SCALE	REV
P2P Analysis & Solutions	20FEB2021	As Indicated	00
DESIGNED BY	DATE	WEIGHT (kg)	SHEET 1 OF 3
P2P Analysis & Solutions	20FEB2021	0kg	

UNLESS OTHERWISE SPECIFIED DIMENSION ARE IN MM  
VIEWS: THIRD ANGLE PROJECTION

REV	DATE	DESCRIPTION
00	20FEB2021	INITIAL REVISION

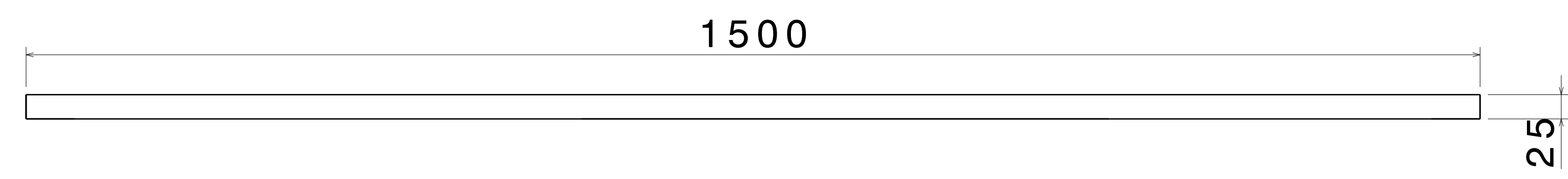

Top view  
Scale: 1:4

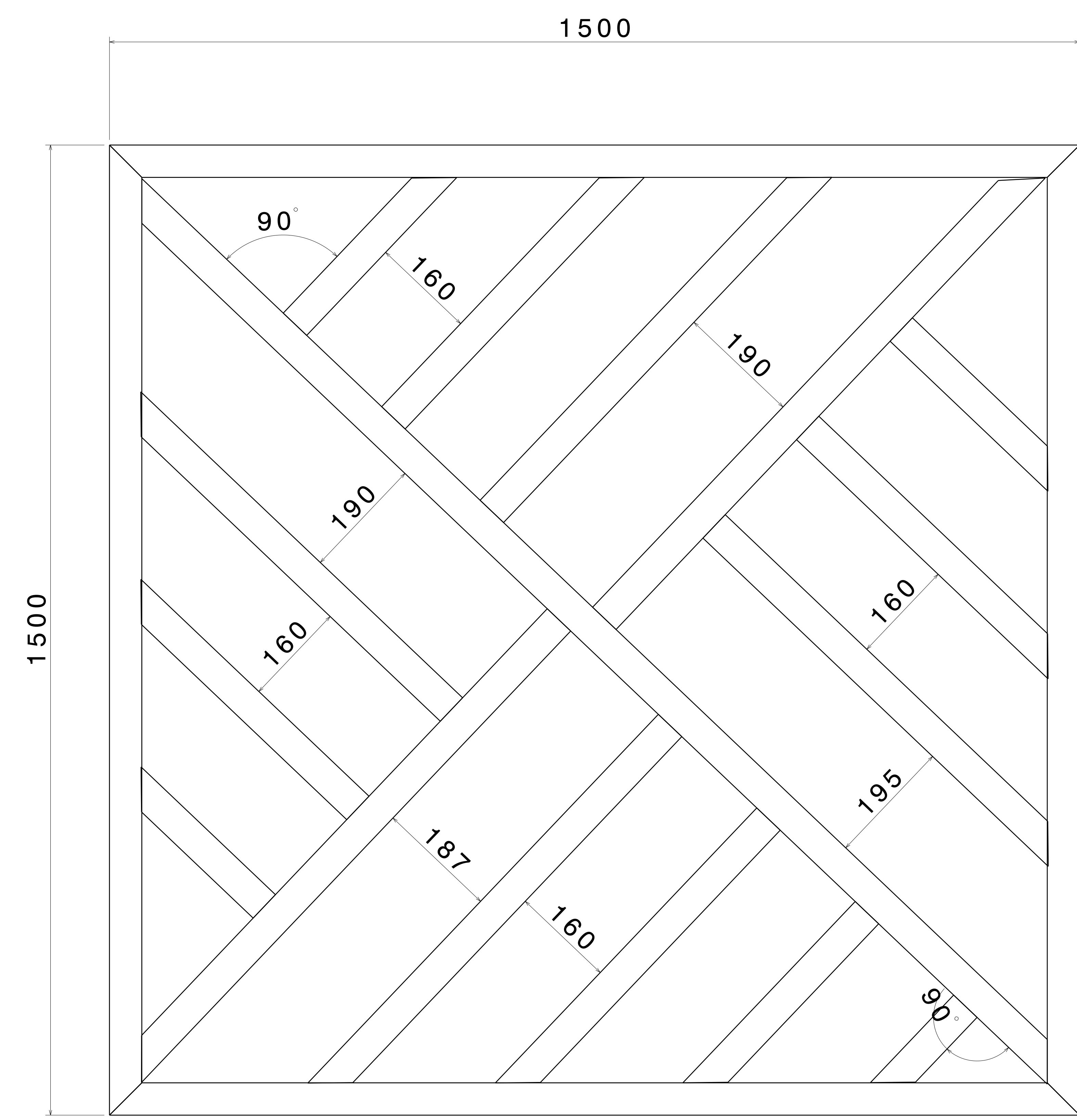

Front view  
Scale: 1:4

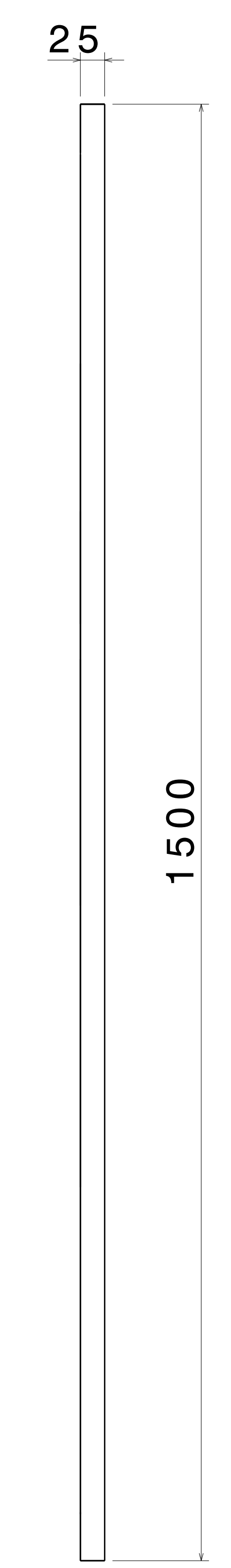

Right view  
Scale: 1:4

UNLESS OTHERWISE SPECIFIED DIMENSION ARE IN MM  
VIEWS: THIRD ANGLE PROJECTION

This drawing is our property. It can't be reproduced or communicated without our written agreement.		APL APOLLO TUBES LTD.	
DRAWN BY SB		DATE 20FEB2021	
CHECKED BY P2P Analysis & Solutions		DATE 20FEB2021	
DESIGNED BY P2P Analysis & Solutions		DATE 20FEB2021	
DRAWING TITLE WINDOW		SIZE A0	DRAWING NUMBER P2P FEB 21-10
SCALE NONE		WEIGHT (kg) XXX	REV 00
			SHEET 2 OF 3

REV	DATE	DESCRIPTION
00	20FEB2021	INITIAL REVISION

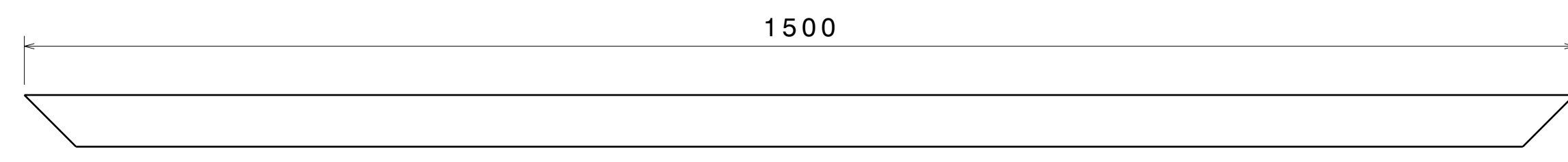

PART 1

Right view  
Scale: 1:5

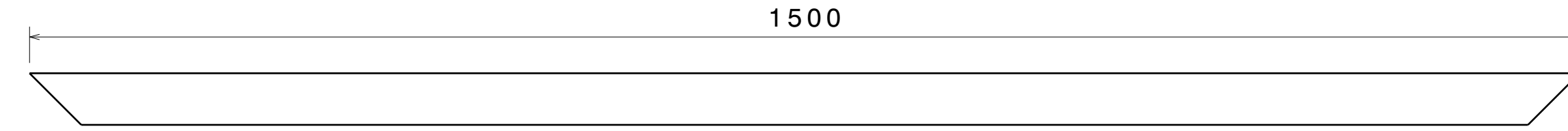

PART 2

Right view  
Scale: 1:5

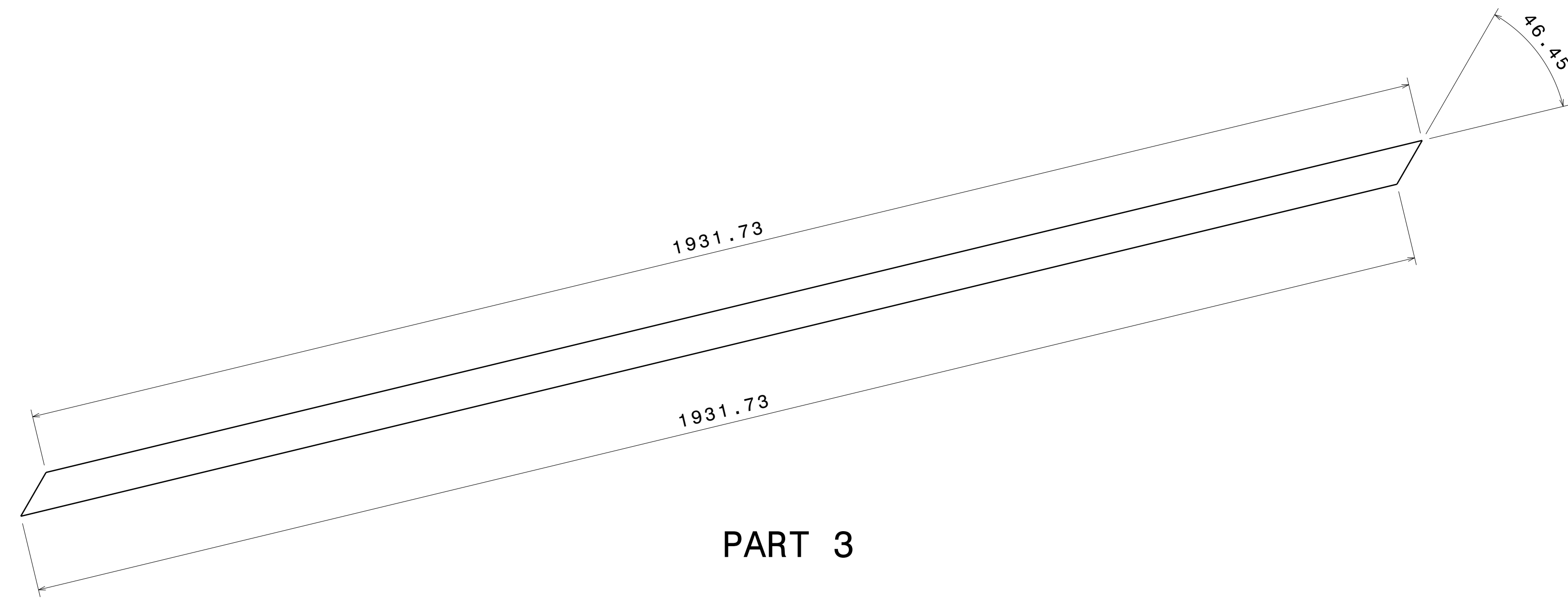

PART 3

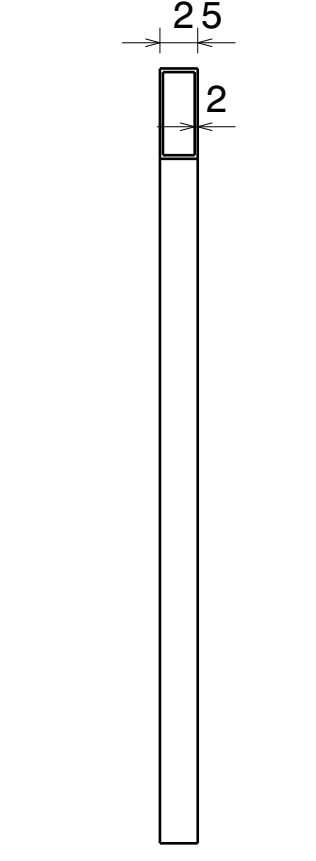

Right view  
Scale: 1:5

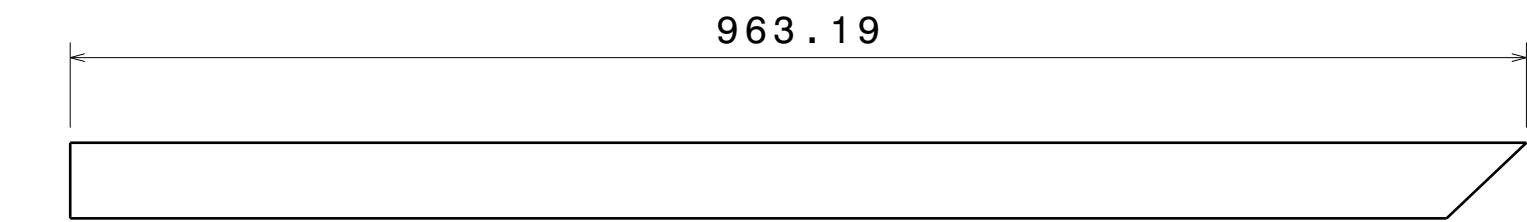

PART 4

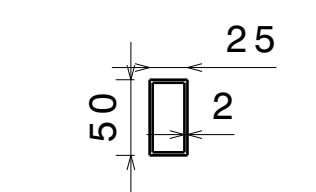

Right view  
Scale: 1:5

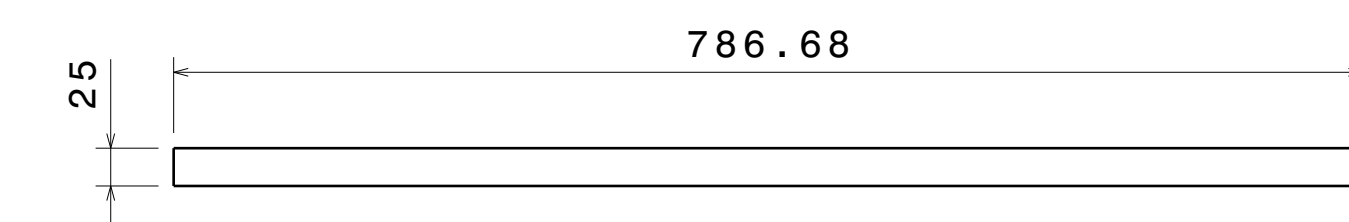

PART 5

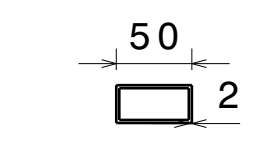

Right view  
Scale: 1:5

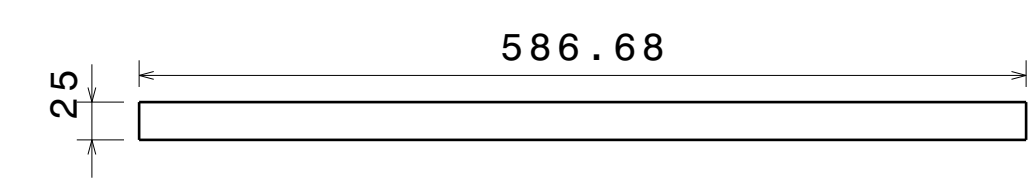

PART 6

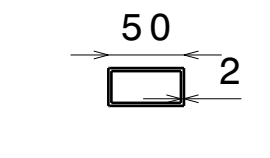

Right view  
Scale: 1:5

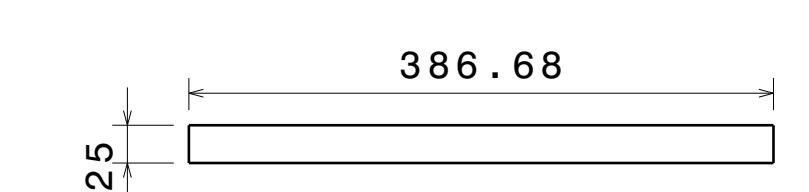

PART 7

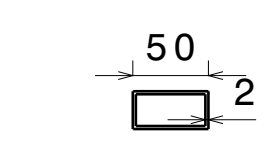

Right view  
Scale: 1:5

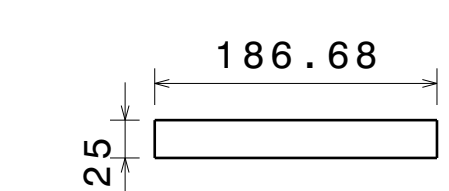

PART 8

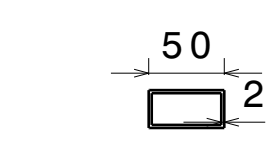

Right view  
Scale: 1:5

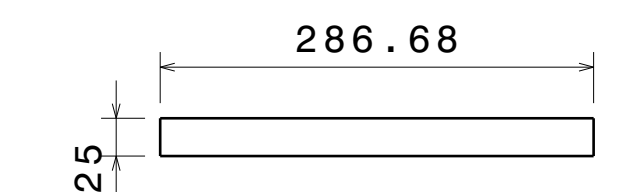

PART 11

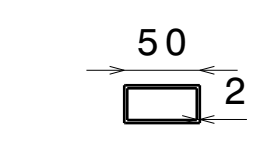

Right view  
Scale: 1:5

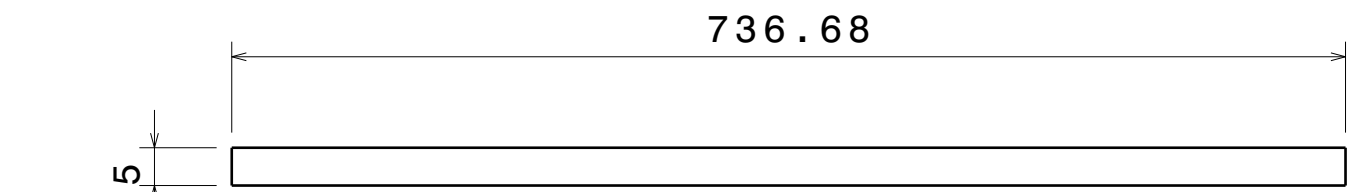

PART 12

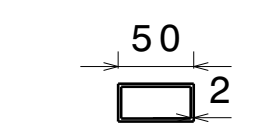

Right view  
Scale: 1:5

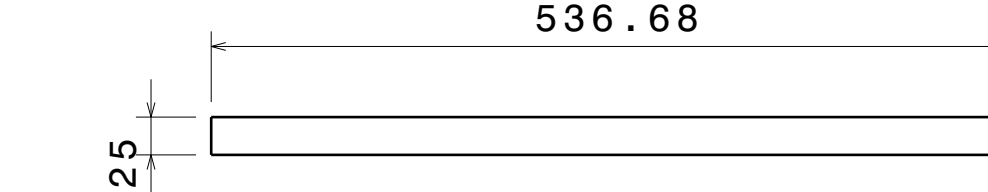

PART 13

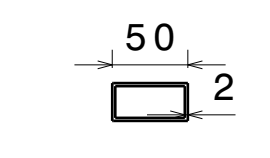

Right view  
Scale: 1:5

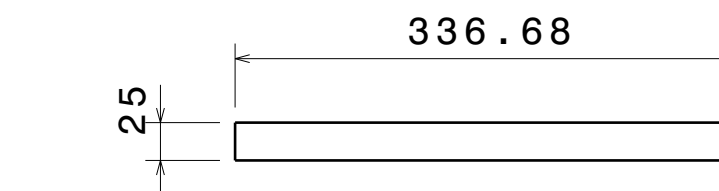

PART 14

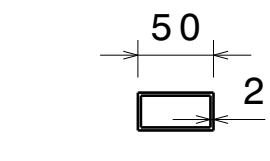

Right view  
Scale: 1:5

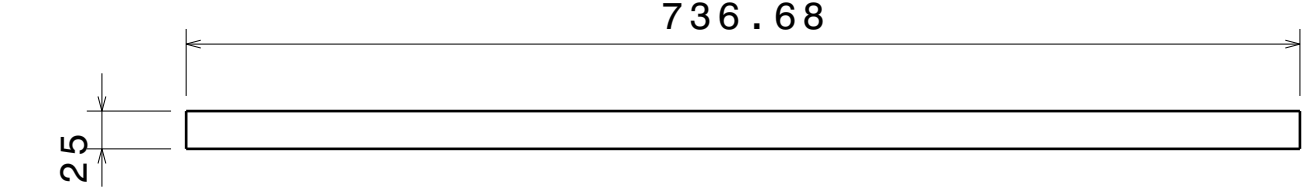

PART 15

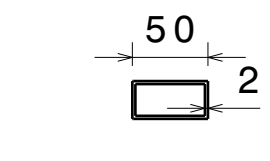

Right view  
Scale: 1:5

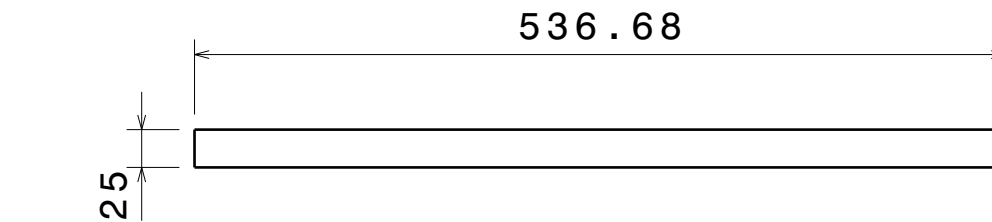

PART 16

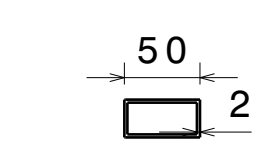

Right view  
Scale: 1:5

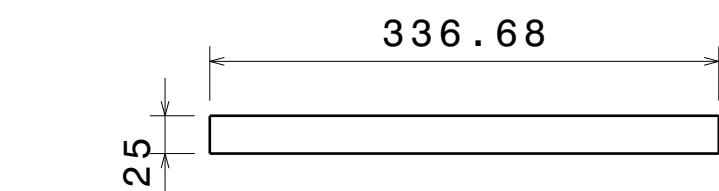

PART 17

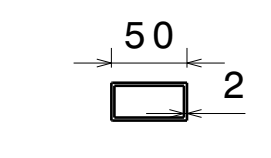

Right view  
Scale: 1:5

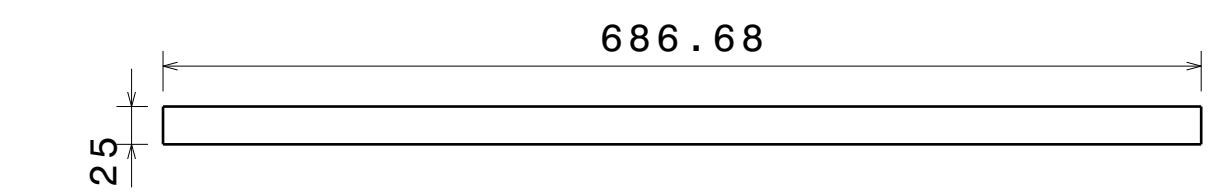

PART 9

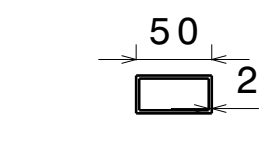

Right view  
Scale: 1:5

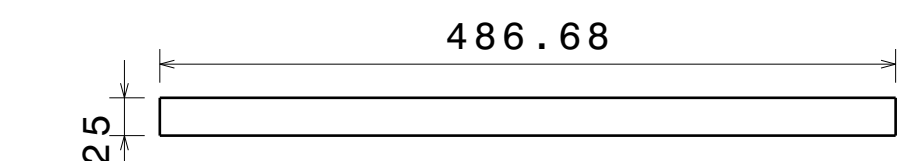

PART 10

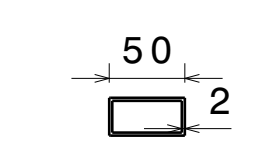

Right view  
Scale: 1:5

UNLESS OTHERWISE SPECIFIED DIMENSION ARE IN MM  
VIEWS: THIRD ANGLE PROJECTION

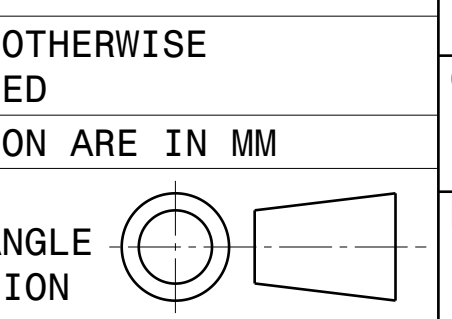

This drawing is our property. It can't be reproduced or communicated without our written agreement.

DRAWN BY	DATE
SB	20FEB2021
CHECKED BY	DATE
P2P Analysis & Solutions	20FEB2021
DESIGNED BY	DATE
P2P Analysis & Solutions	20FEB2021

APL APOLLO TUBES LTD.	
DRAWING TITLE	
WINDOW	
SIZE	DRAWING NUMBER
A0	P2P FEB 21-10
SCALE	NONE WEIGHT (kg) XXX
SHEET 3 OF 3	