

REV/DATE	DESCRIPTION
00 / 22FEB2021	INITIAL REVISION

- NOTES:
- (⊥) ALL VERTICAL SUPPORTS ARE PERPENDICULAR.
  - FLATNESS OF .5MM IS APPLIED BY DEFAULT.
  - ⊞ WELD BEAD OF 2MM RADIUS IS FOLLOWED.
  - ▽▽ SURFACE FINISH MEDIUM TO SMOOTH IS USED.
  - ALL TUBES ARE AS PER APL APOLLO STANDARD. CHANGES MAY EFFECT THE LOAD CAPACITY.
  - ALL HORIZONTAL AND VERTICAL TUBES ARE PERPENDICULAR TO EACH OTHER WITH ±1 DEG.
  - FINE WELDING IS REQUIRED AS PER MENTIONED DETAILS AND FINISHING.
  - HIGHER CURRENT WELDING MAY AFFECT THE BRITTLENESS OF MATERIAL WHICH LATER MAY RAISE TO WEAKENING OF STRUCTURE.
  - FABRICATORS ARE ALLOWED TO USE FITTINGS/FRAMES/SUPPORTS AS NEEDED AND THE SAME MUST BE COMMUNICATED BACK TO ENGINEERING TEAM.
  - BOP COMPONENT WEIGHTS ARE FOR REFERENCE ONLY AND SUBJECTED TO CHANGE PER PURCHASED COMPONENTS.

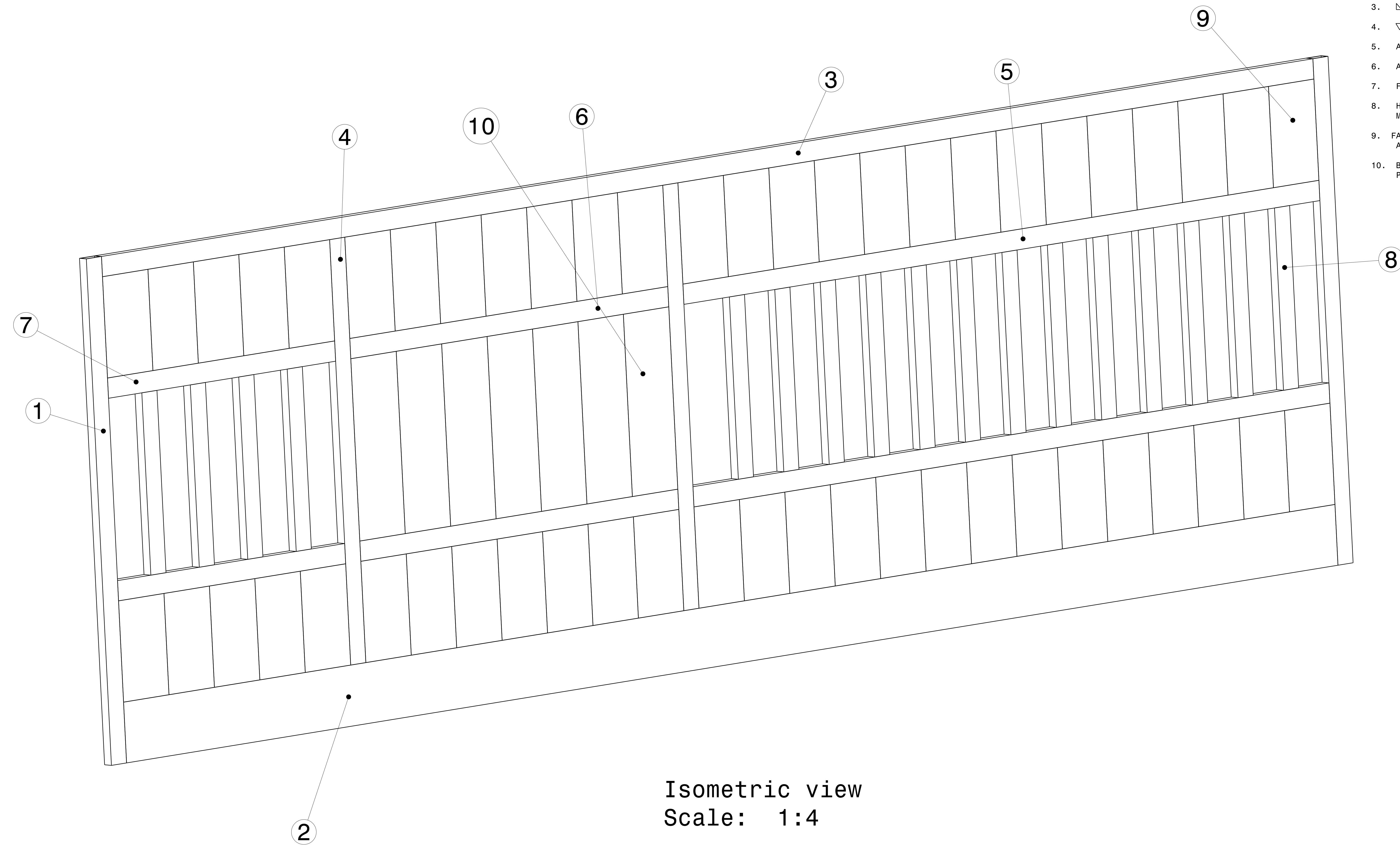

ITEM NO.	PART NUMBER	DESCRIPTION	QTY.	Wt (kg)/Each
10	PLANK 2	150 X 25 X 1.6 X 450	7	1.95
9	PLANK 1	150 X 25 X 1.6 X 250	52	1.10
8	RHS FRAME 8	50 X 25 X 2 X 450	17	1
7	RHS FRAME 7	50 X 25 X 1.6 X 750	2	1.70
6	RHS FRAME 6	50 X 25 X 2 X 1050	2	2.35
5	RHS FRAME 5	50 X 25 X 2 X 2100	2	4.70
4	RHS FRAME 4	50 X 25 X 2 X 1050	2	2.35
3	RHS FRAME 3	50 X 25 X 2 X 4000	1	8.90
2	RHS FRAME 2	150 X 25 X 2 X 4000	1	21.50
1	RHS FRAME 1	50 X 25 X 2 X 1250	2	2.80

This drawing is our property. It can't be reproduced or communicated without our written agreement.

**APL APOLLO TUBES LTD.**

**DRAWING TITLE**  
GATE

DRAWN BY <b>RR</b>	DATE 22FEB2021	SIZE <b>A0</b>	DRAWING NUMBER <b>P2P FEB 21-15</b>	REV <b>00</b>
CHECKED BY P2P Analysis & Solutions	DATE 22FEB2021	SCALE As Indicated	WEIGHT(kg) 0kg	SHEET 1 OF 3
DESIGNED BY P2P Analysis & Solutions	DATE 22FEB2021			

UNLESS OTHERWISE SPECIFIED DIMENSION ARE IN MM  
VIEWS: THIRD ANGLE PROJECTION

REV	DATE	DESCRIPTION
00	22FEB2021	INITIAL REVISION

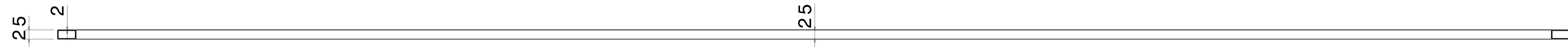

Top view  
Scale: 1:5

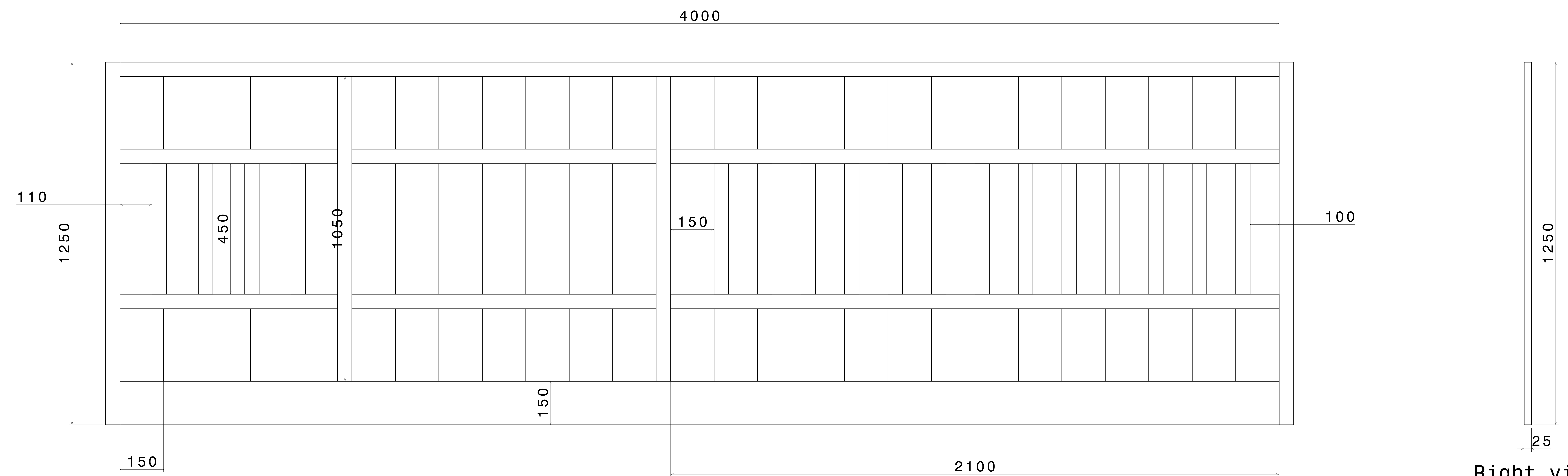

Front view  
Scale: 1:5

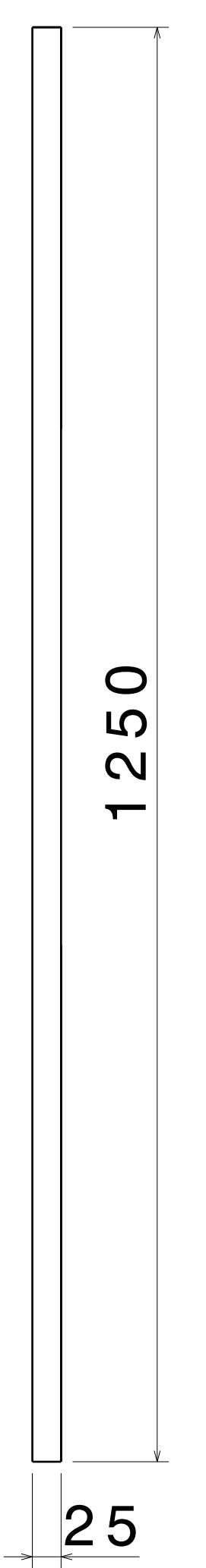

Right view  
Scale: 1:5

UNLESS OTHERWISE SPECIFIED DIMENSION ARE IN MM  
VIEWS: THIRD ANGLE PROJECTION

This drawing is our property. It can't be reproduced or communicated without our written agreement.		APL APOLLO TUBES LTD.	
DRAWN BY SB		DATE 22FEB2021	
CHECKED BY P2P Analysis & Solutions		DATE 22FEB2021	
DESIGNED BY P2P Analysis & Solutions		DATE 22FEB2021	
SIZE A0	DRAWING NUMBER P2P FEB 21-15		REV 00
SCALE NONE	WEIGHT (kg)	XXX	SHEET 2 OF 3

REV	DATE	DESCRIPTION
00	22FEB2021	INITIAL REVISION

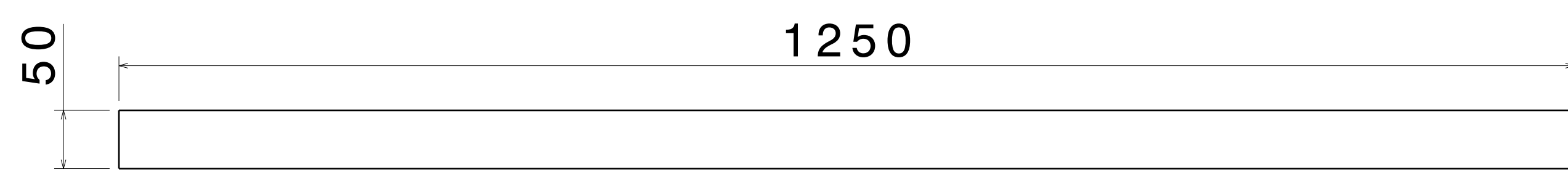

ITEM 1

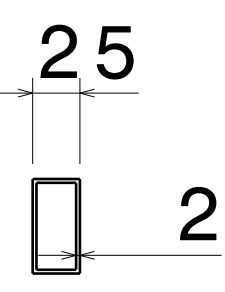

Right view  
Scale: 1:4

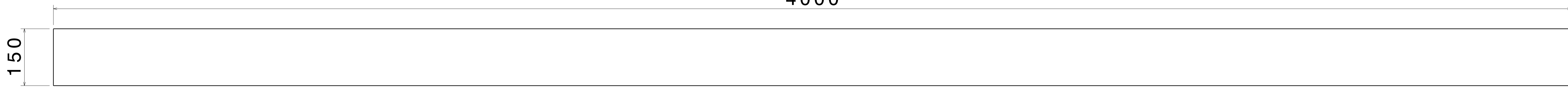

ITEM 2

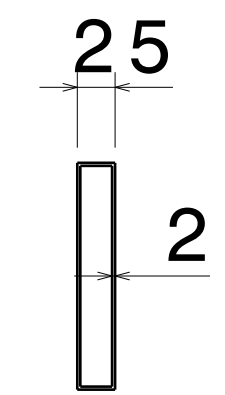

Right view  
Scale: 1:5

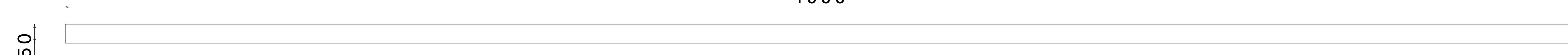

ITEM 3

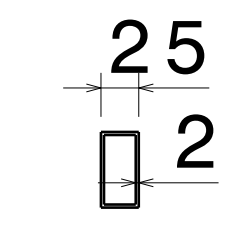

Right view  
Scale: 1:5

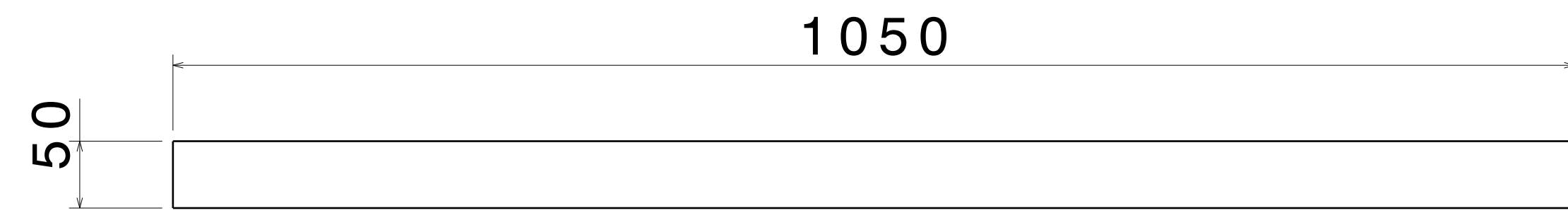

ITEM 4

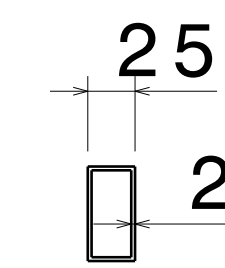

Right view  
Scale: 1:4

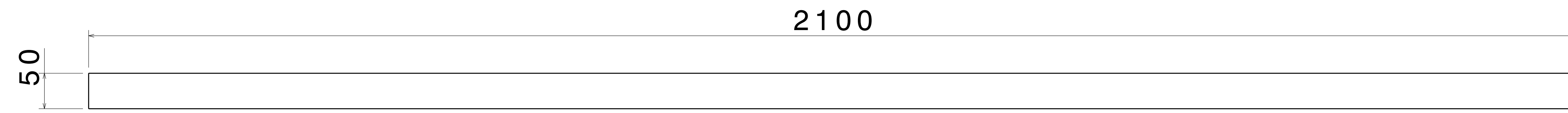

ITEM 5

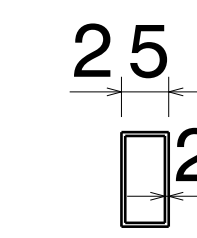

Right view  
Scale: 1:4

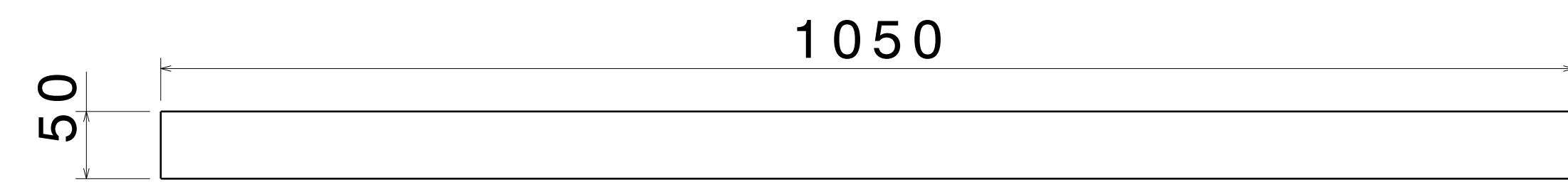

ITEM 6

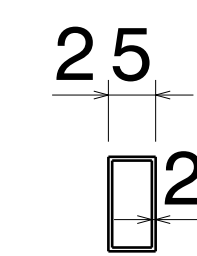

Right view  
Scale: 1:4

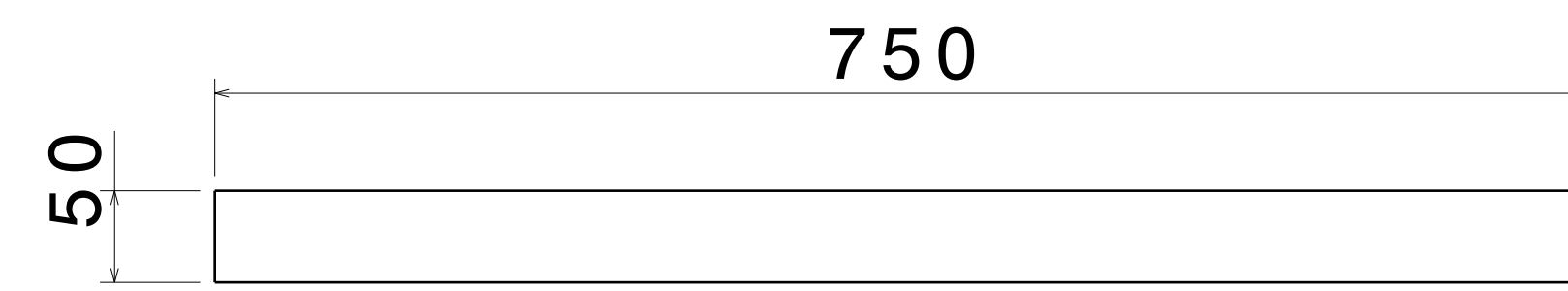

ITEM 7

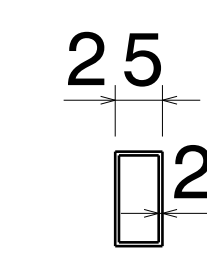

Right view  
Scale: 1:4

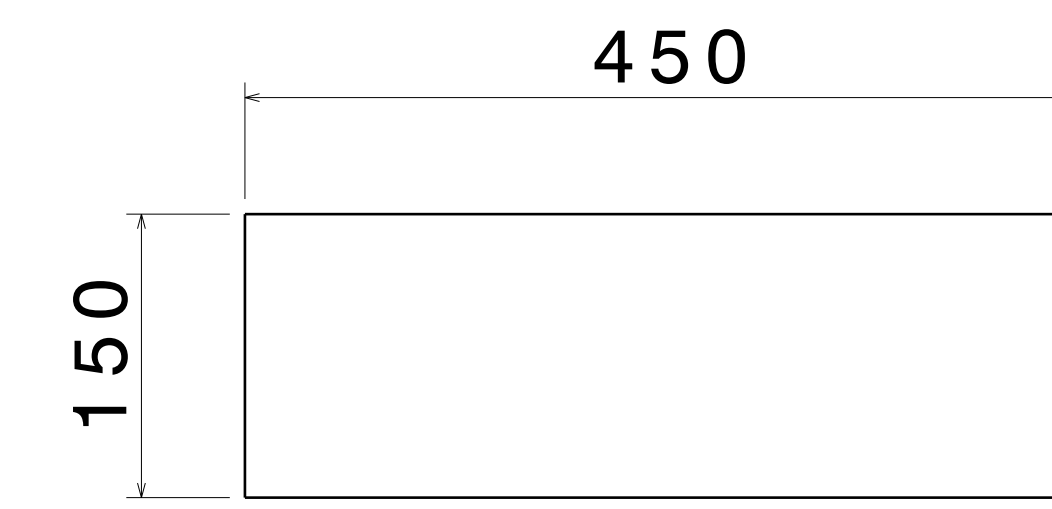

ITEM 10

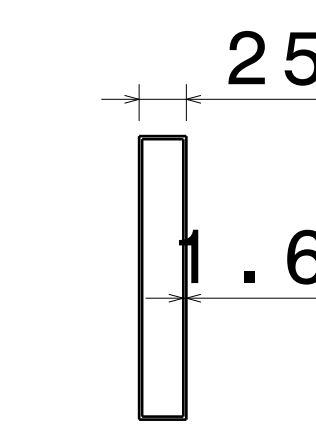

Right view  
Scale: 1:4

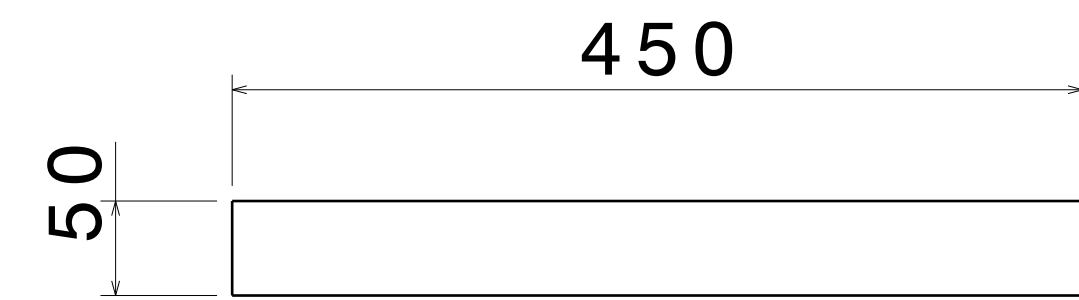

ITEM 8

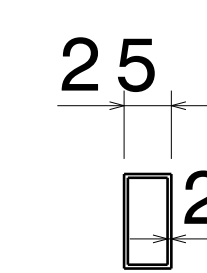

Right view  
Scale: 1:4

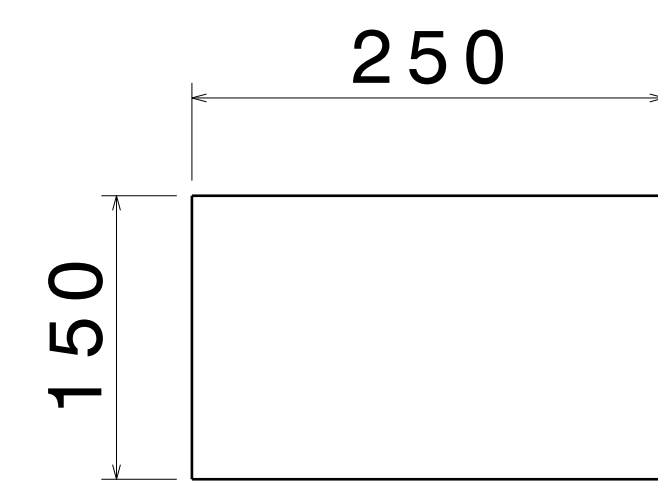

ITEM 9

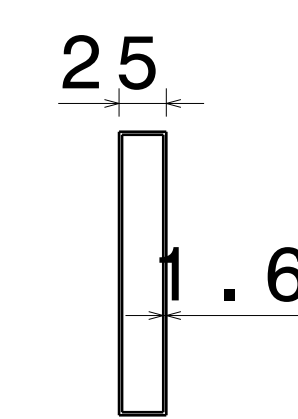

Right view  
Scale: 1:4

UNLESS OTHERWISE SPECIFIED DIMENSION ARE IN MM  
VIEWS: THIRD ANGLE PROJECTION

This drawing is our property. It can't be reproduced or communicated without our written agreement.

APL APOLLO TUBES LTD.

DRAWN BY	DATE
SB	22FEB2021
CHECKED BY	DATE
P2P Analysis & Solutions	22FEB2021
DESIGNED BY	DATE
P2P Analysis & Solutions	22FEB2021

DRAWING TITLE			
GATE			
SIZE	DRAWING NUMBER	REV	
A0	P2P FEB 21-15	00	
SCALE	NONE	WEIGHT (kg)	XXX
			SHEET 3 OF 3