

REV	DATE	DESCRIPTION
00	26FEB2021	INITIAL REVISION

- NOTES:
- (⊥) ALL VERTICAL SUPPORTS ARE PERPENDICULAR.
  - FLATNESS OF .5MM IS APPLIED BY DEFAULT.
  - ⊲ WELD BEAD OF 2MM RADIUS IS FOLLOWED.
  - ▽▽ SURFACE FINISH MEDIUM TO SMOOTH IS USED.
  - ALL TUBES ARE AS PER APL APOLLO STANDARD. CHANGES MAY EFFECT THE LOAD CAPACITY.
  - ALL HORIZONTAL AND VERTICAL TUBES ARE PERPENDICULAR TO EACH OTHER WITH ±1 DEG.
  - FINE WELDING IS REQUIRED AS PER MENTIONED DETAILS AND FINISHING.
  - HIGHER CURRENT WELDING MAY AFFECT THE BRITTLENESS OF MATERIAL WHICH LATER MAY RAISE TO WEAKENING OF STRUCTURE.
  - FABRICATORS ARE ALLOWED TO USE FITTINGS/FRAMES/SUPPORTS AS NEEDED AND THE SAME MUST BE COMMUNICATED BACK TO ENGINEERING TEAM.
  - BOP COMPONENT WEIGHTS ARE FOR REFERENCE ONLY AND SUBJECTED TO CHANGE PER PURCHASED COMPONENTS.

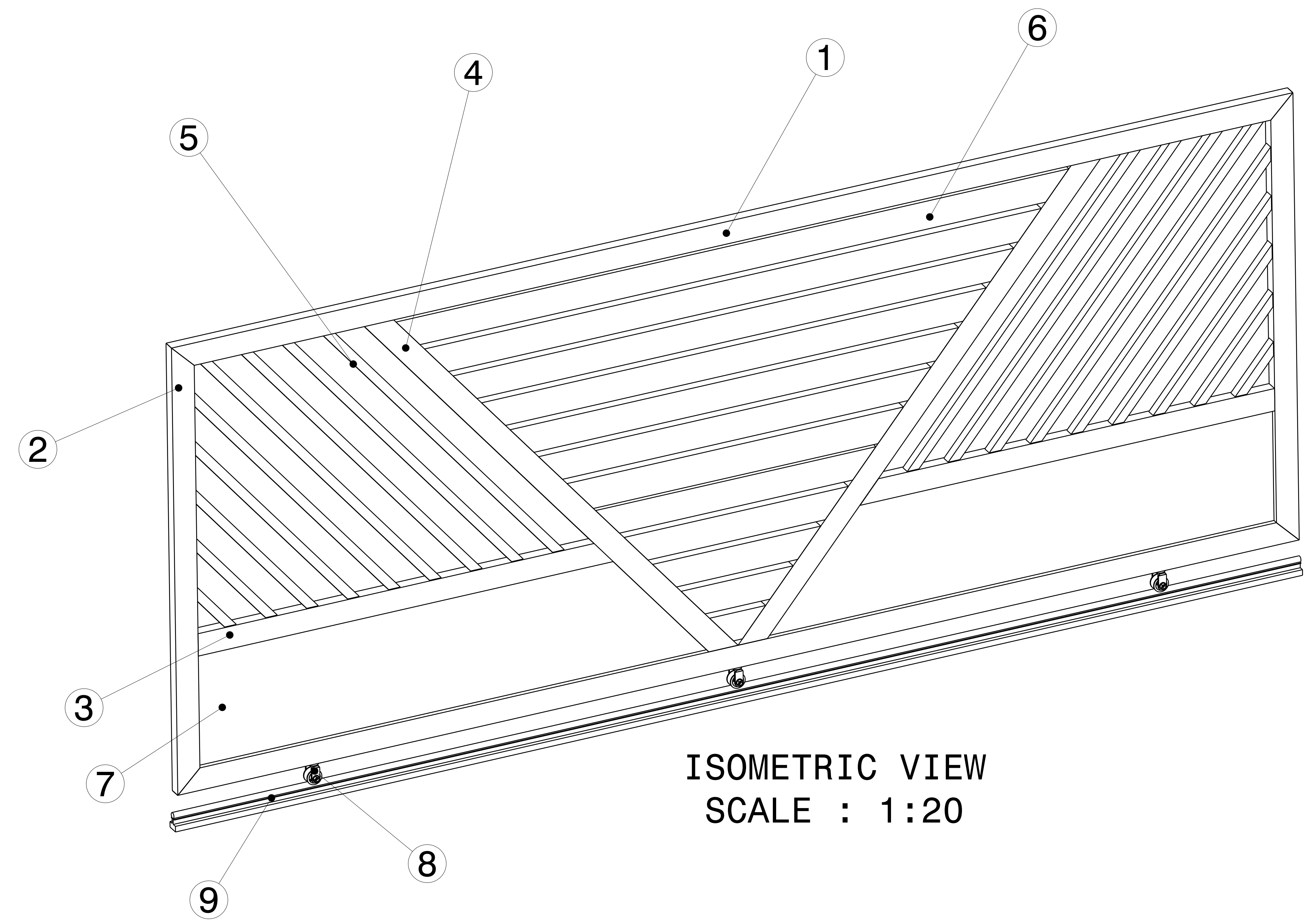

ISOMETRIC VIEW  
SCALE : 1:20

ITEM NO.	PART NUMBER	DESCRIPTION	QTY.	Wt (Kg)/Each
9	BOP RAILING	-----	1	----
8	BOP WHEEL ASSY	-----	3	----
7	BOP LASER CUT PANEL FRAME	4538.9 X 1000 X 5	2	323.78
6	RHS FRAME 5	250 X 100 X 4 X --	12	---
5	SHS FRAME 1	80 X 80 X 2 X --	18	---
4	RHS FRAME 4	200 X 100 X 2 X 4867.3	2	43.73
3	RHS FRAME 3	200 X 100 X 2 X 3700	2	33.65
2	RHS FRAME 2	200 X 100 X 2 X 4001.5	2	35.38
1	RHS FRAME 1	200 X 100 X 2 X 10000	2	91.2

UNLESS OTHERWISE SPECIFIED DIMENSION ARE IN MM  
VIEWS: THIRD ANGLE PROJECTION

This drawing is our property. It can't be reproduced or communicated without our written agreement.		APL APOLLO TUBES LTD.	
DRAWN BY VM		DATE 26FEB2021	
CHECKED BY P2P Analysis & Solutions		DATE 26FEB2021	
DESIGNED BY P2P Analysis & Solutions		DATE 26FEB2021	
DRAWING TITLE SLIDING GATE 1		SIZE A0	DRAWING NUMBER P2P FEB21 - 13
SCALE As Indicated		WEIGHT(kg) 0kg	SHEET 1 OF 3

REV	DATE	DESCRIPTION
00	26FEB2021	INITIAL REVISION

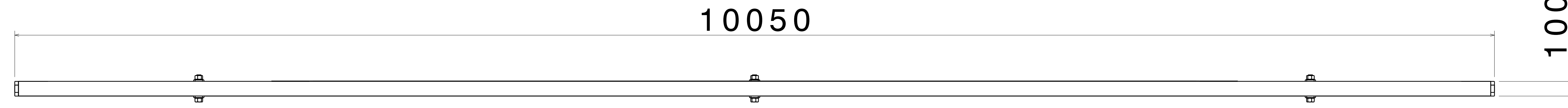

TOP VIEW  
SCALE: 1:10

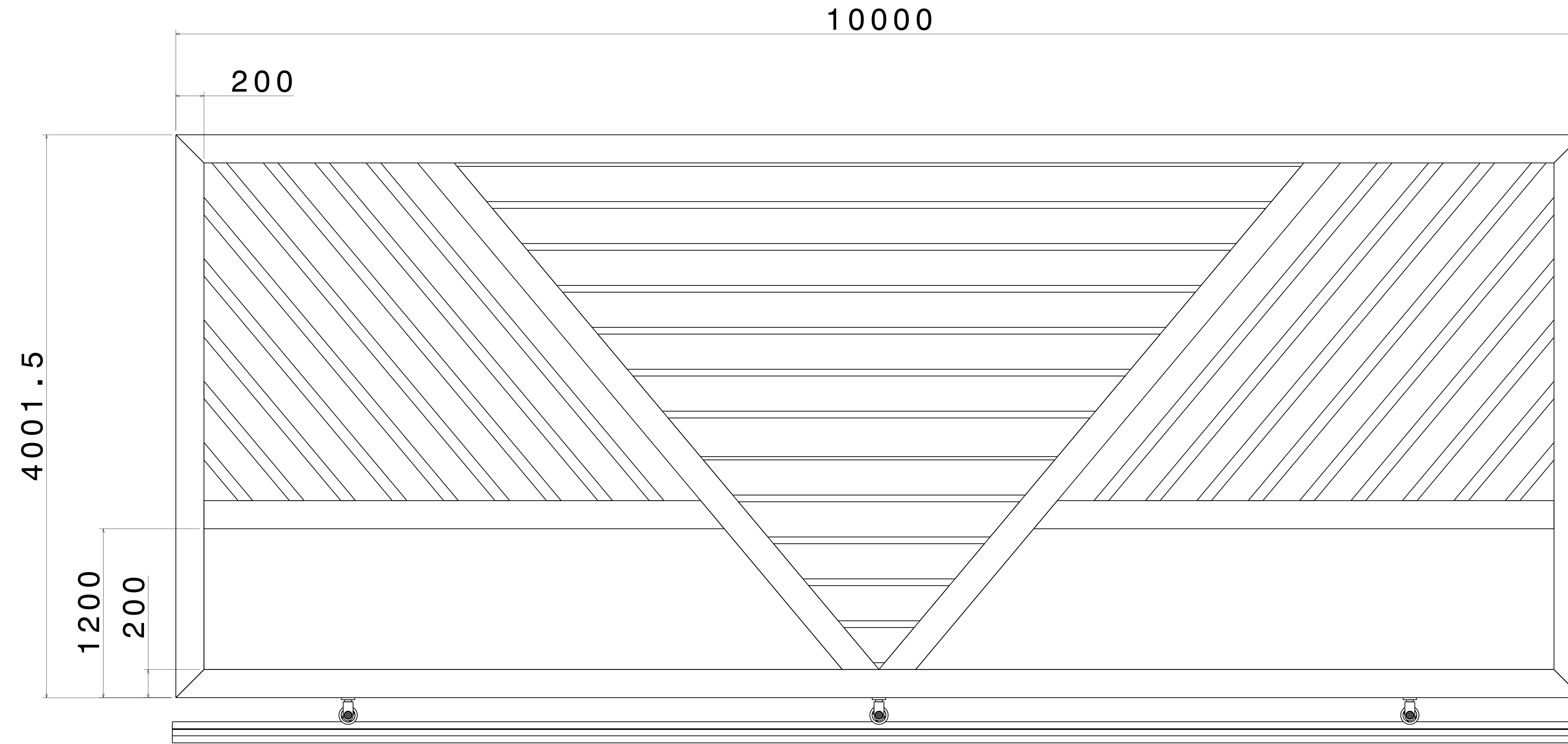

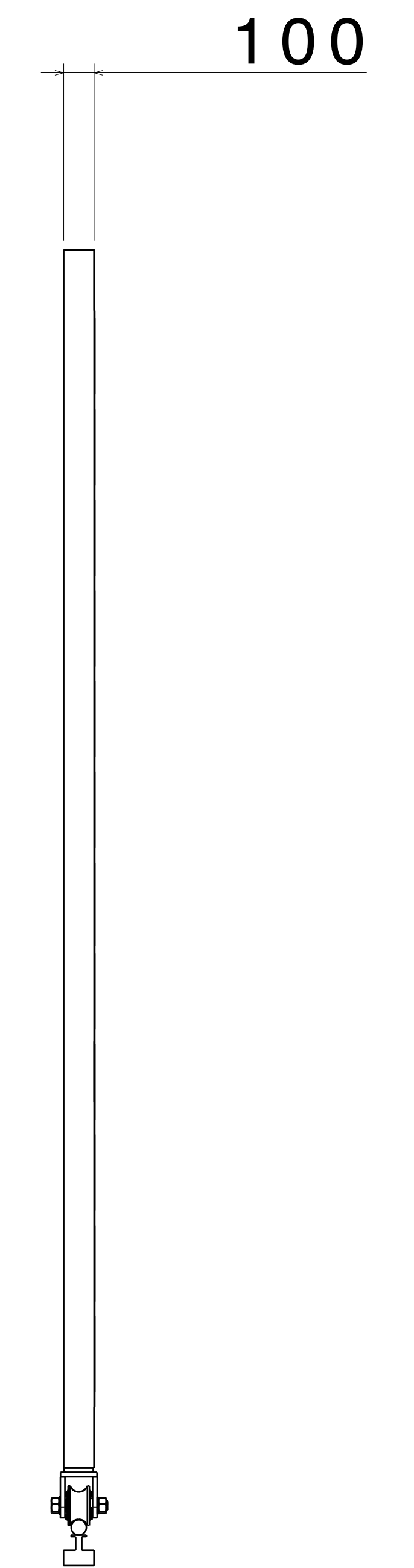

FRONT VIEW  
SCALE: 1:10

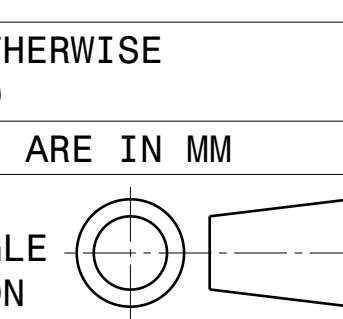

RIGHT VIEW  
SCALE: 1:10

UNLESS OTHERWISE SPECIFIED DIMENSION ARE IN MM  
VIEWS: THIRD ANGLE PROJECTION



This drawing is our property. It can't be reproduced or communicated without our written agreement.		APL APOLLO TUBES LTD. 	
DRAWN BY SB		DATE 26FEB2021	
CHECKED BY P2P Analysis & Solutions		DATE 26FEB2021	
DESIGNED BY P2P Analysis & Solutions		DATE 26FEB2021	
SIZE A0	DRAWING NUMBER P2P_FEB21-13	REV 00	
SCALE NONE	WEIGHT (kg) XXX	SHEET 2 OF 3	

DRAWING TITLE  
SLIDING GATE 1



REV	DATE	DESCRIPTION
00	26FEB2021	INITIAL REVISION

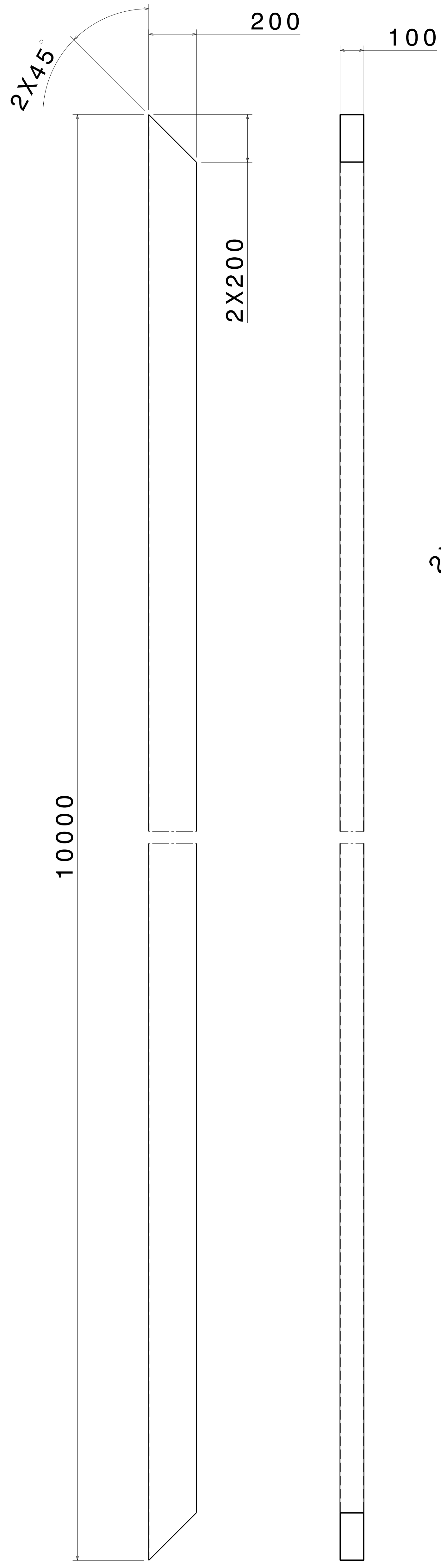

FRONT VIEW RIGHT VIEW  
SCALE: 1:10 SCALE: 1:10  
ITEM 1, RHS FRAME 1  
THICKNESS - 2.0MM

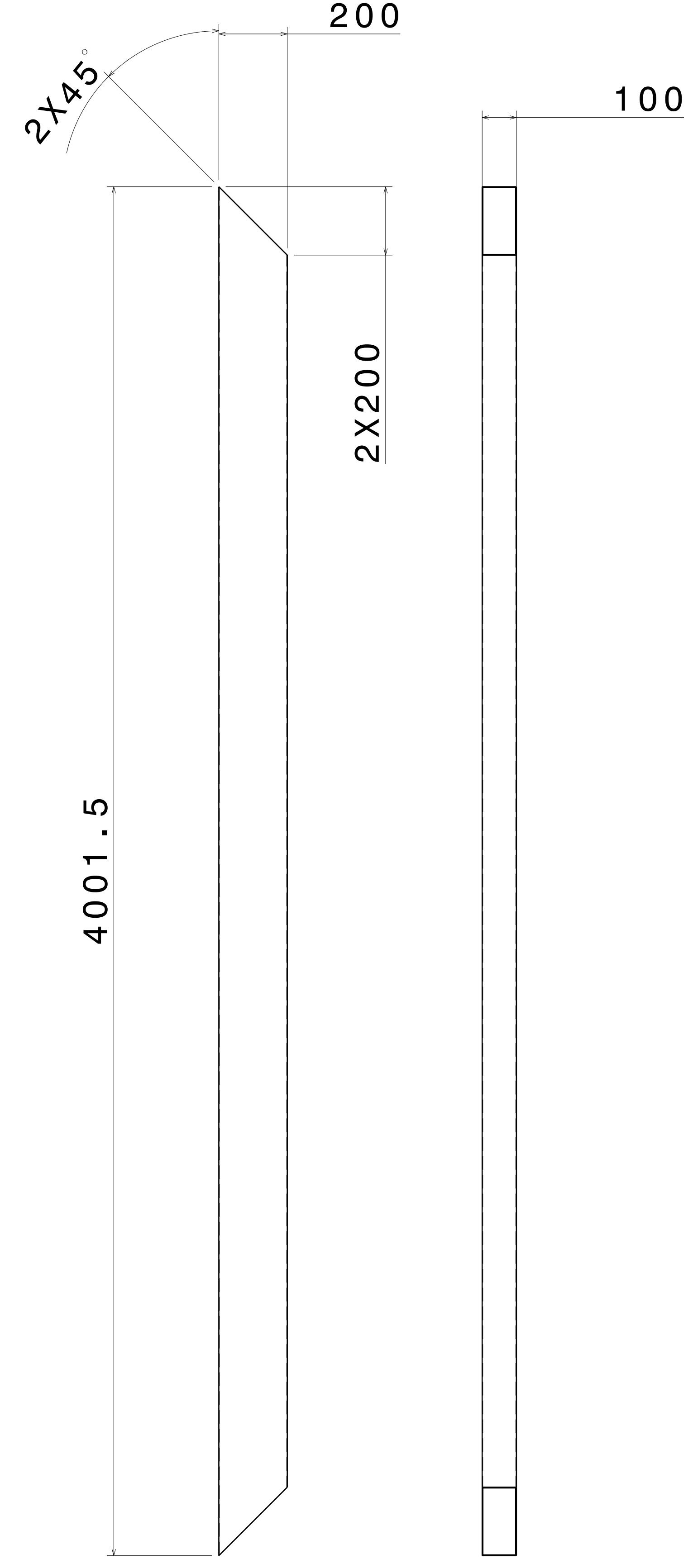

FRONT VIEW RIGHT VIEW  
SCALE: 1:10 SCALE: 1:10  
ITEM 2, RHS FRAME 2  
THICKNESS - 2.0MM

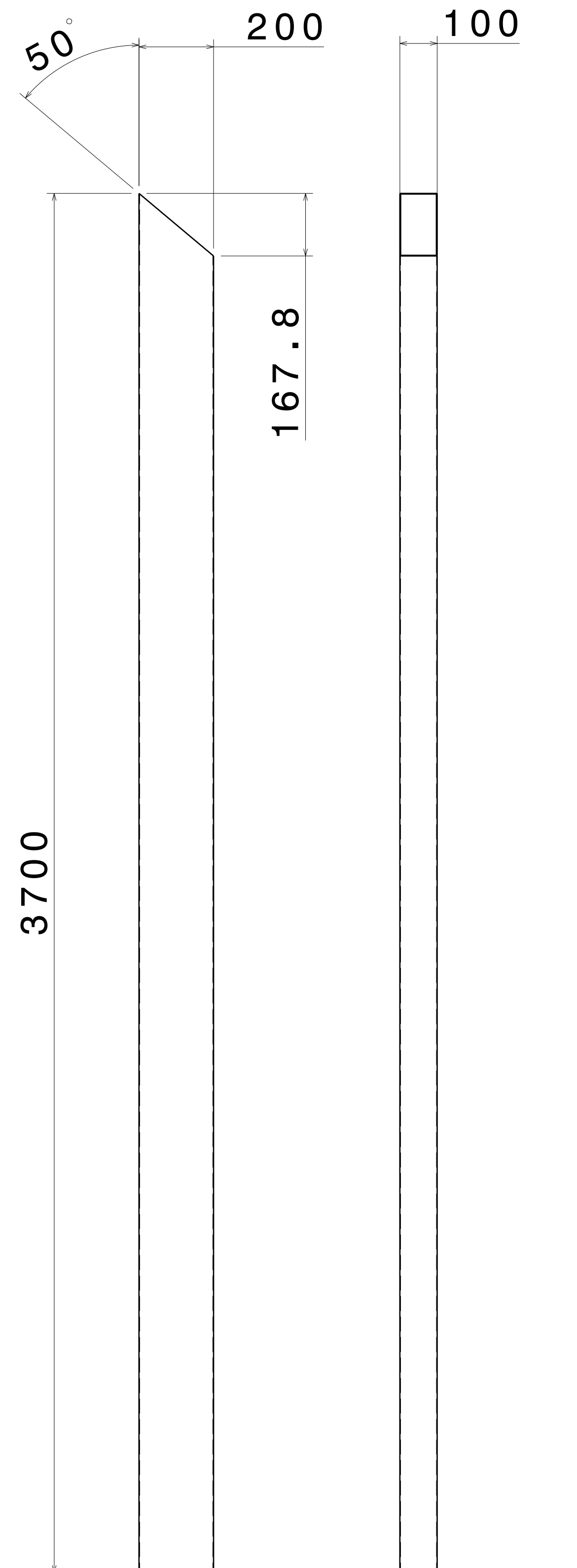

FRONT VIEW RIGHT VIEW  
SCALE: 1:10 SCALE: 1:10  
ITEM 3, RHS FRAME 3  
THICKNESS - 2.0MM

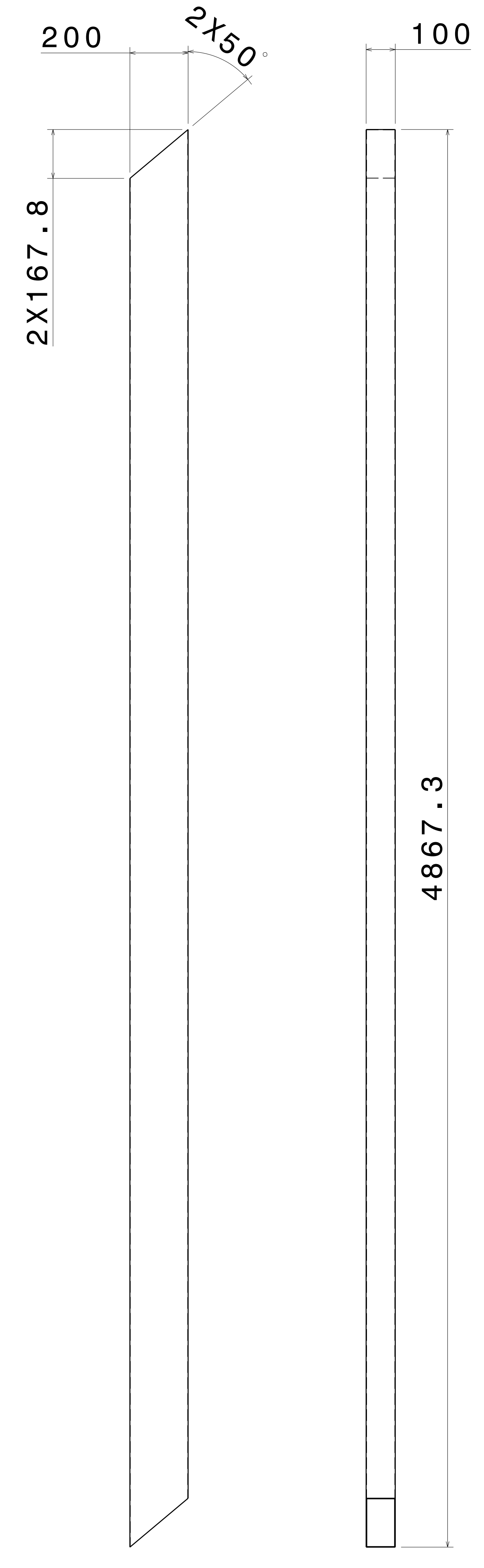

FRONT VIEW RIGHT VIEW  
SCALE: 1:10 SCALE: 1:10  
ITEM 4, RHS FRAME 4  
THICKNESS - 2.0MM

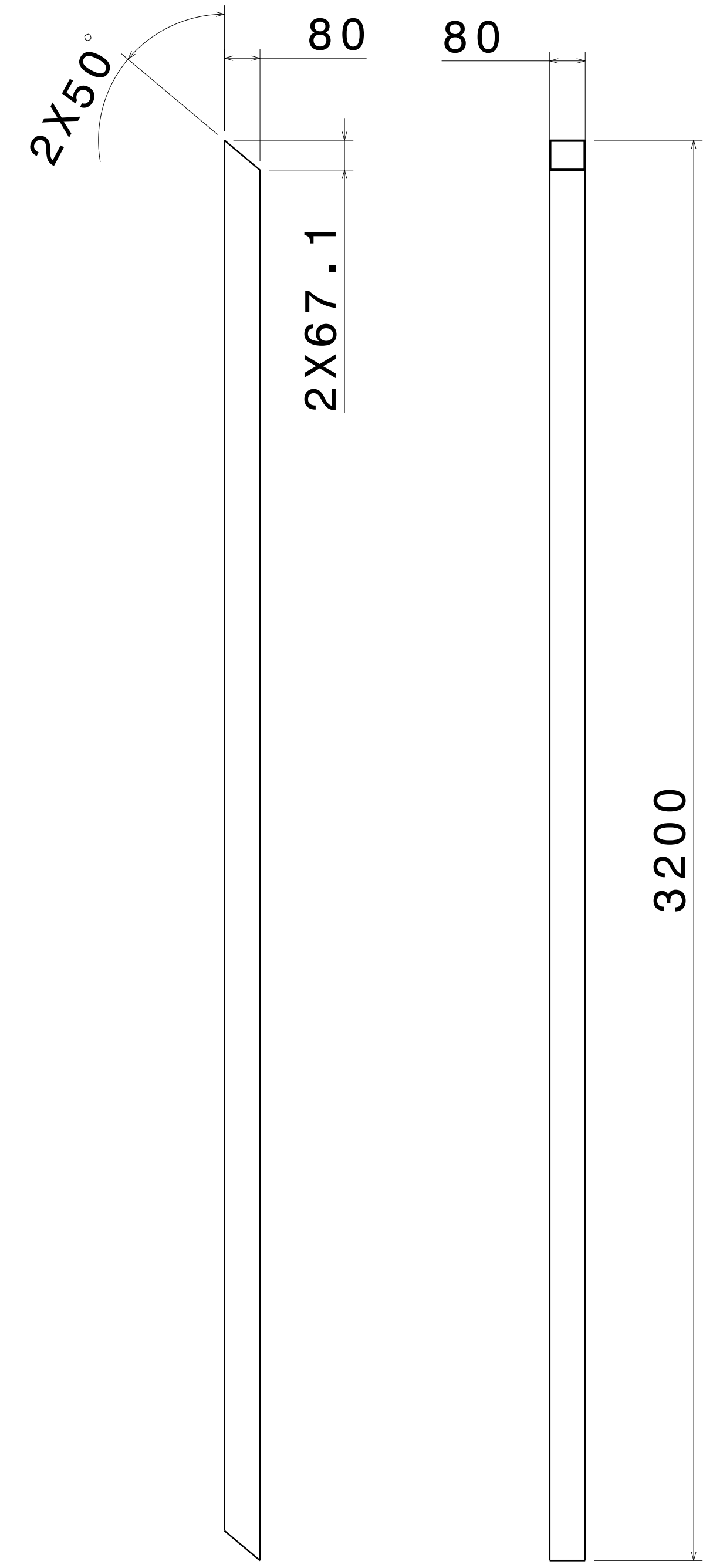

FRONT VIEW RIGHT VIEW  
SCALE: 1:10 SCALE: 1:10  
ITEM 5, SHS FRAME 1  
THICKNESS - 2.0MM  
NOTE : LENGTH WILL BE  
CUSTOMIZED BASED ON DESIGN

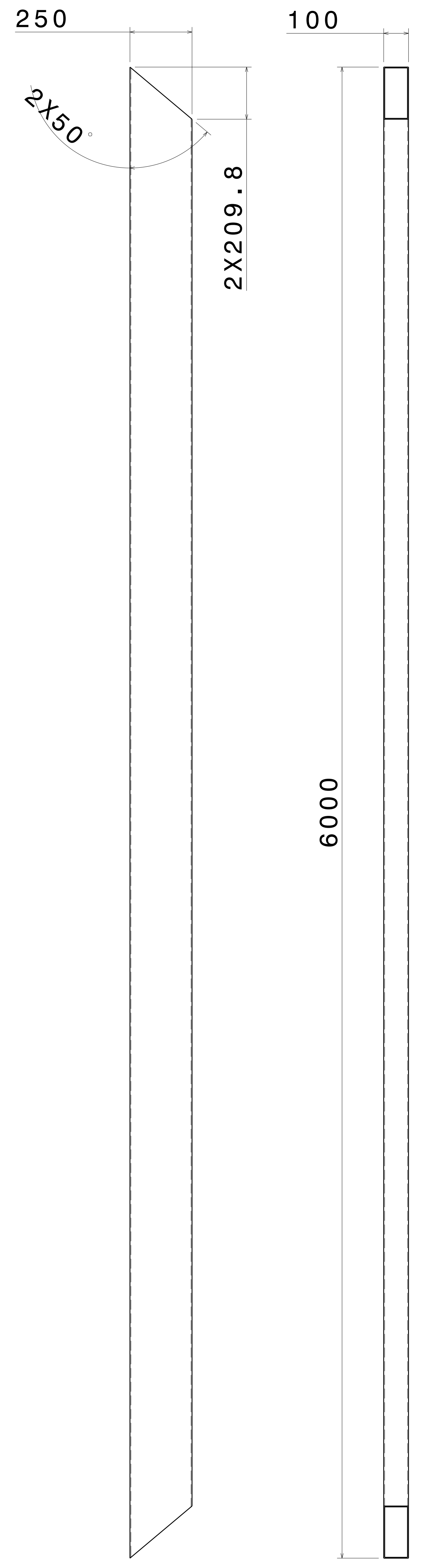

FRONT VIEW RIGHT VIEW  
SCALE: 1:10 SCALE: 1:10  
ITEM 6, RHS FRAME 5  
THICKNESS - 2.0MM

NOTE : LENGTH  
WILL BE  
CUSTOMIZED  
BASED ON  
DESIGN

UNLESS OTHERWISE  
SPECIFIED  
DIMENSION ARE IN MM  
VIEWS:  
THIRD ANGLE  
PROJECTION

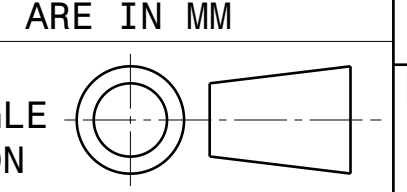

This drawing is our property.  
It can't be reproduced  
or communicated without  
our written agreement.

DRAWN BY		DATE		DRAWING TITLE	
SB		26FEB2021		SLIDING GATE 1	
CHECKED BY	P2P Analysis & Solutions	DATE	26FEB2021	SIZE	DRAWING NUMBER
DESIGNED BY	P2P Analysis & Solutions	DATE	26FEB2021	A0	P2P FEB21-13
SCALE	NONE	WEIGHT (kg)	XXX	REV	00
					SHEET 3 OF 3

