

REV/DATE	DESCRIPTION
00 24JAN2021	INITIAL REVISION

- NOTES:
- (⊥) ALL VERTICAL SUPPORTS ARE PERPENDICULAR.
 - FLATNESS OF .5MM IS APPLIED BY DEFAULT.
 - ⊲ WELD BEAD OF 2MM RADIUS IS FOLLOWED.
 - ▽ SURFACE FINISH MEDIUM TO SMOOTH IS USED.
 - ALL TUBES ARE AS PER APL APOLLO STANDARD. CHANGES MAY EFFECT THE LOAD CAPACITY.
 - ALL HORIZONTAL AND VERTICAL TUBES ARE PERPENDICULAR TO EACH OTHER WITH ±1 DEG.
 - FINE WELDING IS REQUIRED AS PER MENTIONED DETAILS AND FINISHING.
 - HIGHER CURRENT WELDING MAY AFFECT THE BRITTLNESS OF MATERIAL WHICH LATER MAY RAISE TO WEAKENING OF STRUCTURE.
 - FABRICATORS ARE ALLOWED TO USE FITTINGS/FRAMES/SUPPORTS AS NEEDED AND THE SAME MUST BE COMMUNICATED BACK TO ENGINEERING TEAM.
 - BOP COMPONENT WEIGHTS ARE FOR REFERENCE ONLY AND SUBJECTED TO CHANGE PER PURCHASED COMPONENTS.

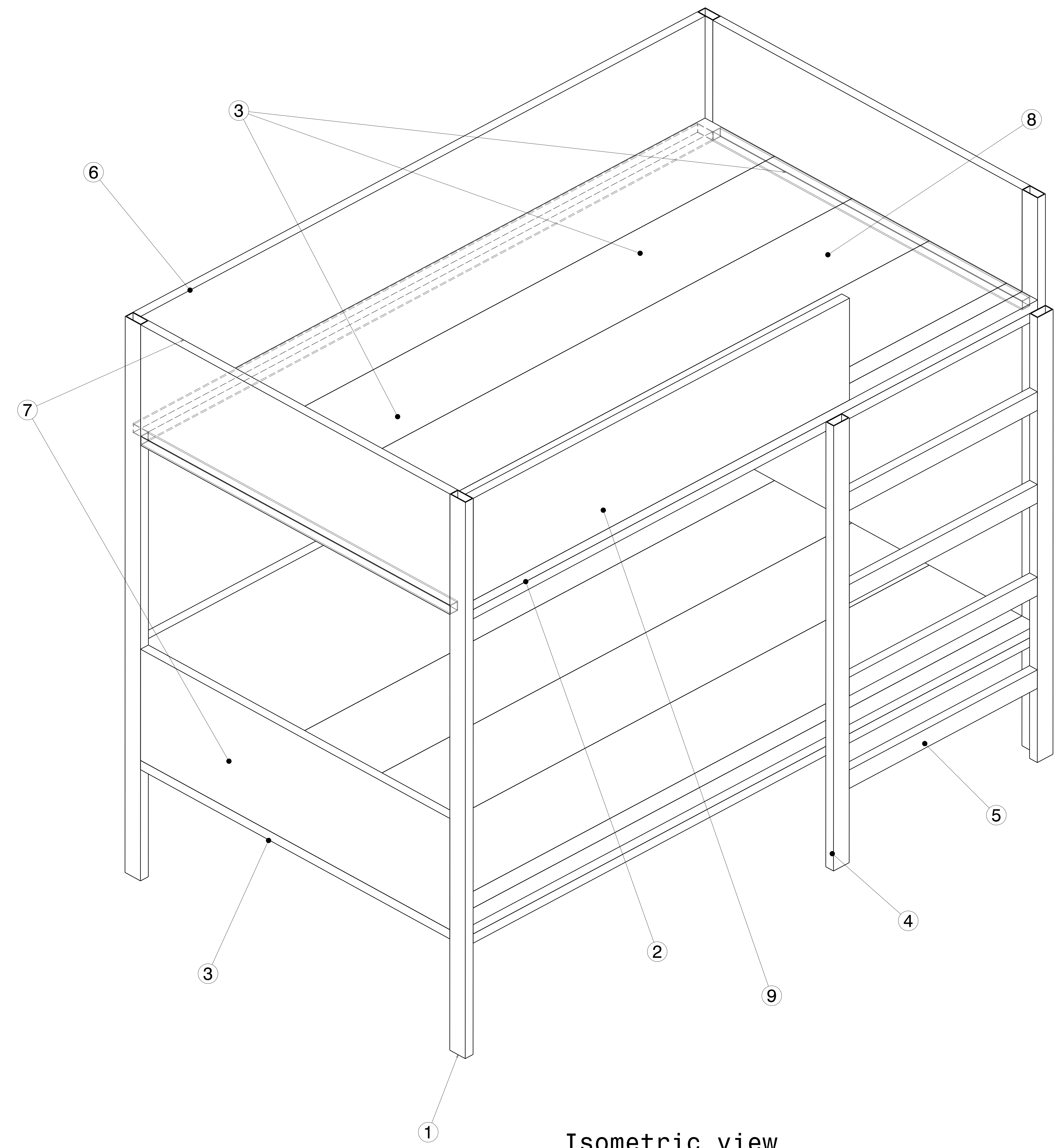

Isometric view
Scale: 1:4

ITEM NO.	PART NUMBER	DESCRIPTION	QTY.	Wt (Kg)/Each
9	PLANK 4	275 X 25 X 1.6 X 600	1	4.48
8	PLANK 3	250 X 25 X 1.6 X 1800	8	12.3
7	PLANK 2	275 X 25 X 1.6 X 1000	3	8.1
6	PLANK 1	275 X 25 X 1.6 X 1800	2	13.44
5	RHS FRAME 5	50 X 25 X 2 X 600	4	1.34
4	RHS FRAME 4	50 X 25 X 2 X 1200	2	2.68
3	RHS FRAME 3	25 X 25 X 2 X 1000	8	1.45
2	RHS FRAME 2	50 X 25 X 2 X 1800	8	4.02
1	RHS FRAME 1	50 X 25 X 2 X 1500	4	1.36

This drawing is our property. It can't be reproduced or communicated without our written agreement.

APL APOLLO TUBES LTD.

DRAWING TITLE: JAN 21-16

DRAWN BY: SB DATE: 24JAN2021

CHECKED BY: P2P Analysis & Solutions DATE: 24JAN2021

DESIGNED BY: P2P Analysis & Solutions DATE: 24JAN2021

SIZE: A0 DRAWING NUMBER: JAN 21-16 REV: 00

SCALE: As Indicated WEIGHT (kg): 0kg SHEET 1 OF 3

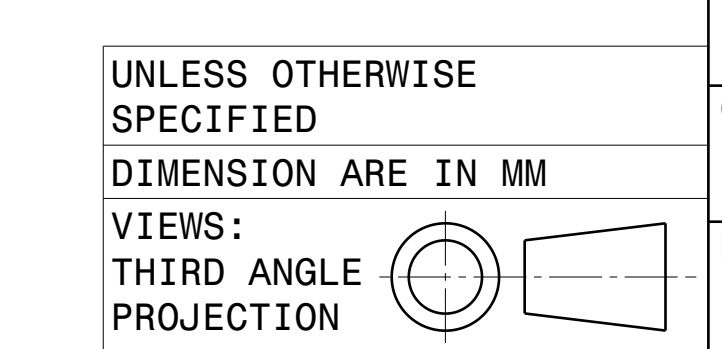

REV	DATE	DESCRIPTION
00	24JAN2021	INITIAL REVISION

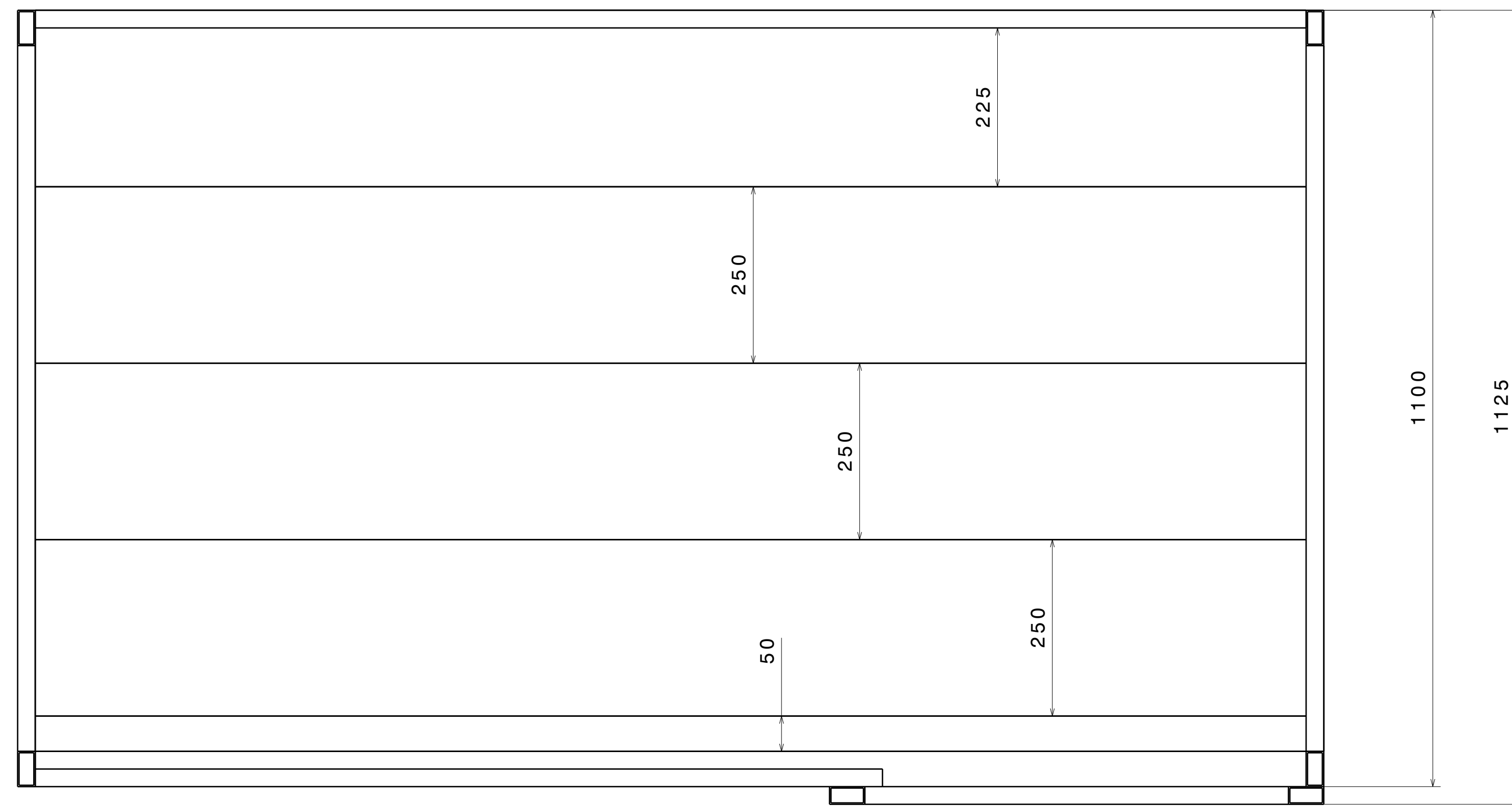

Top view

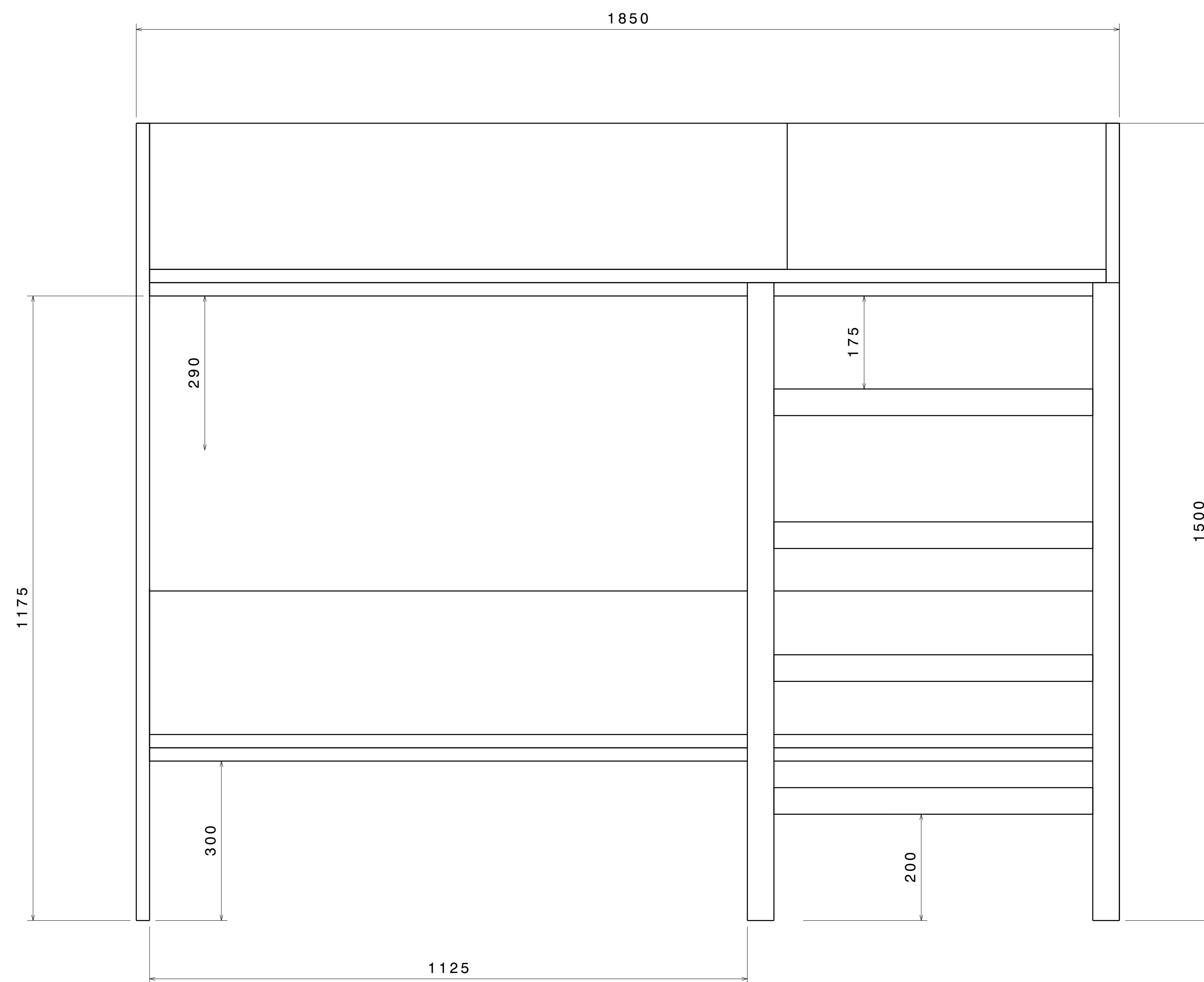

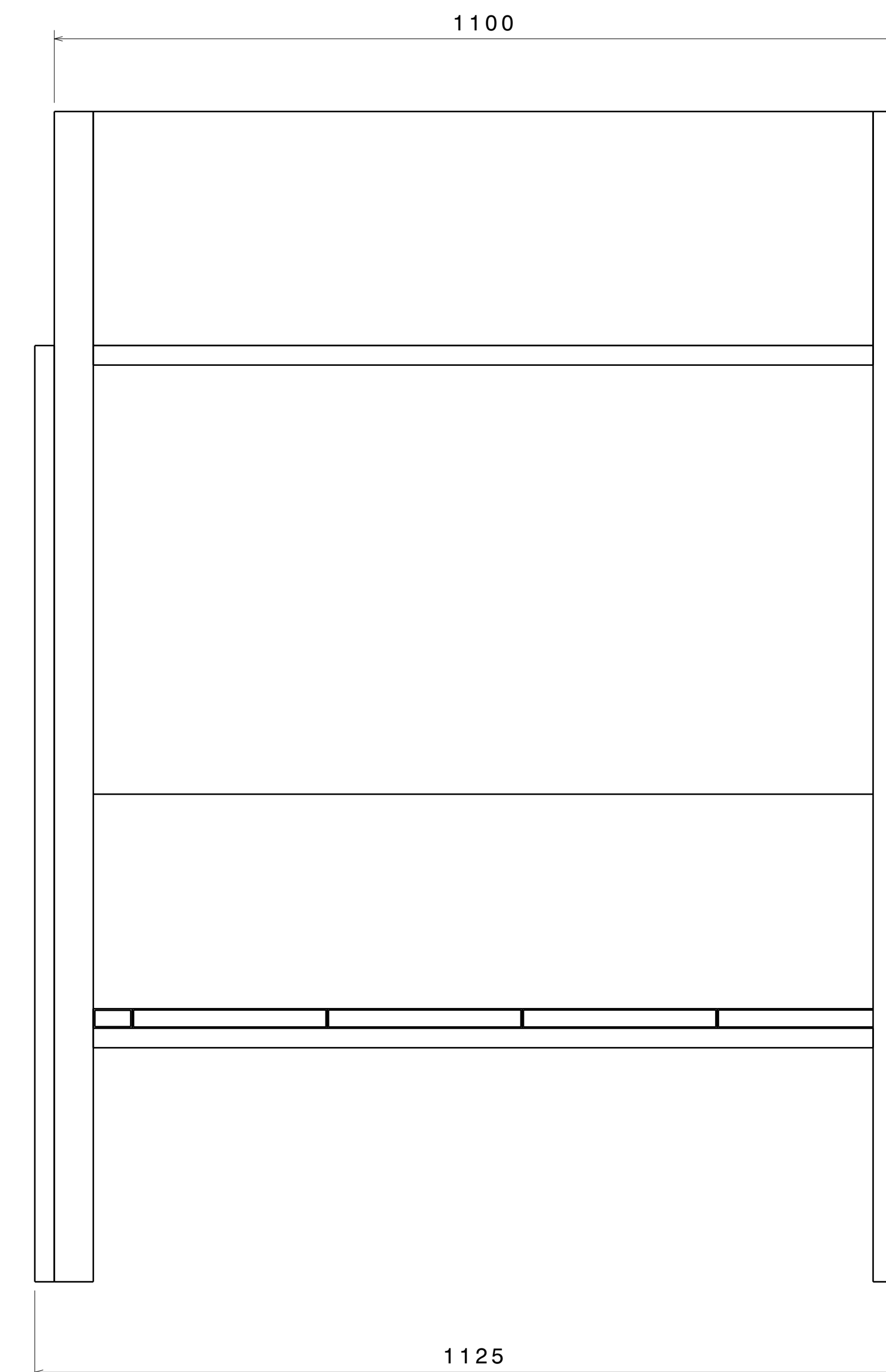

Front view

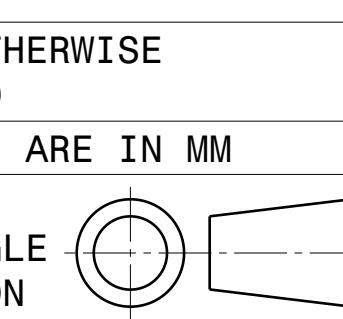

Right view

UNLESS OTHERWISE SPECIFIED DIMENSION ARE IN MM
 VIEWS: THIRD ANGLE PROJECTION



This drawing is our property. It can't be reproduced or communicated without our written agreement.		APL APOLLO TUBES LTD. 	
DRAWN BY SB		DATE 24JAN2021	
CHECKED BY P2P Analysis & Solutions		DATE 24JAN2021	
DESIGNED BY P2P Analysis & Solutions		DATE 24JAN2021	
DRAWING TITLE JAN 21-16		SIZE A0	REV 00
SCALE NONE		WEIGHT (kg) XXX	SHEET 2 OF 3

REV	DATE	DESCRIPTION
00	24JAN2021	INITIAL REVISION

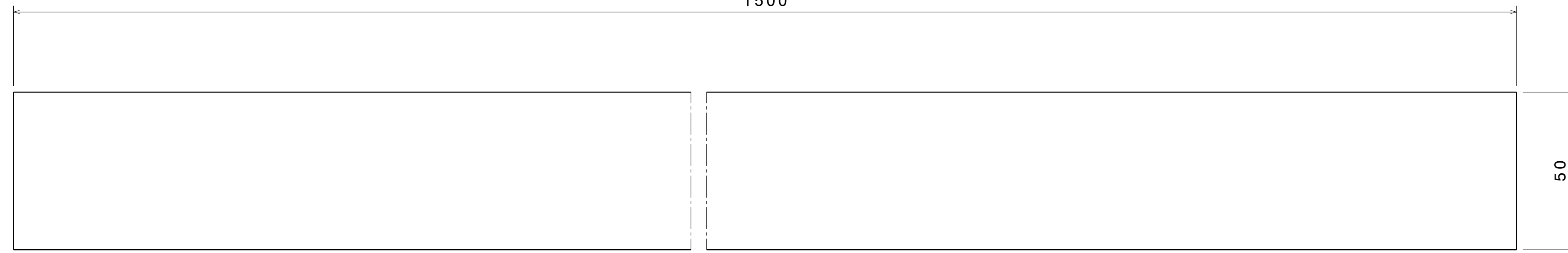

ITEM 1

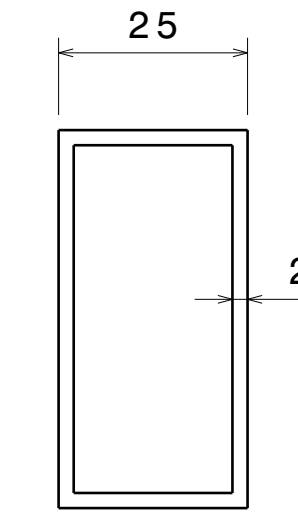

Right view
Scale: 1:1

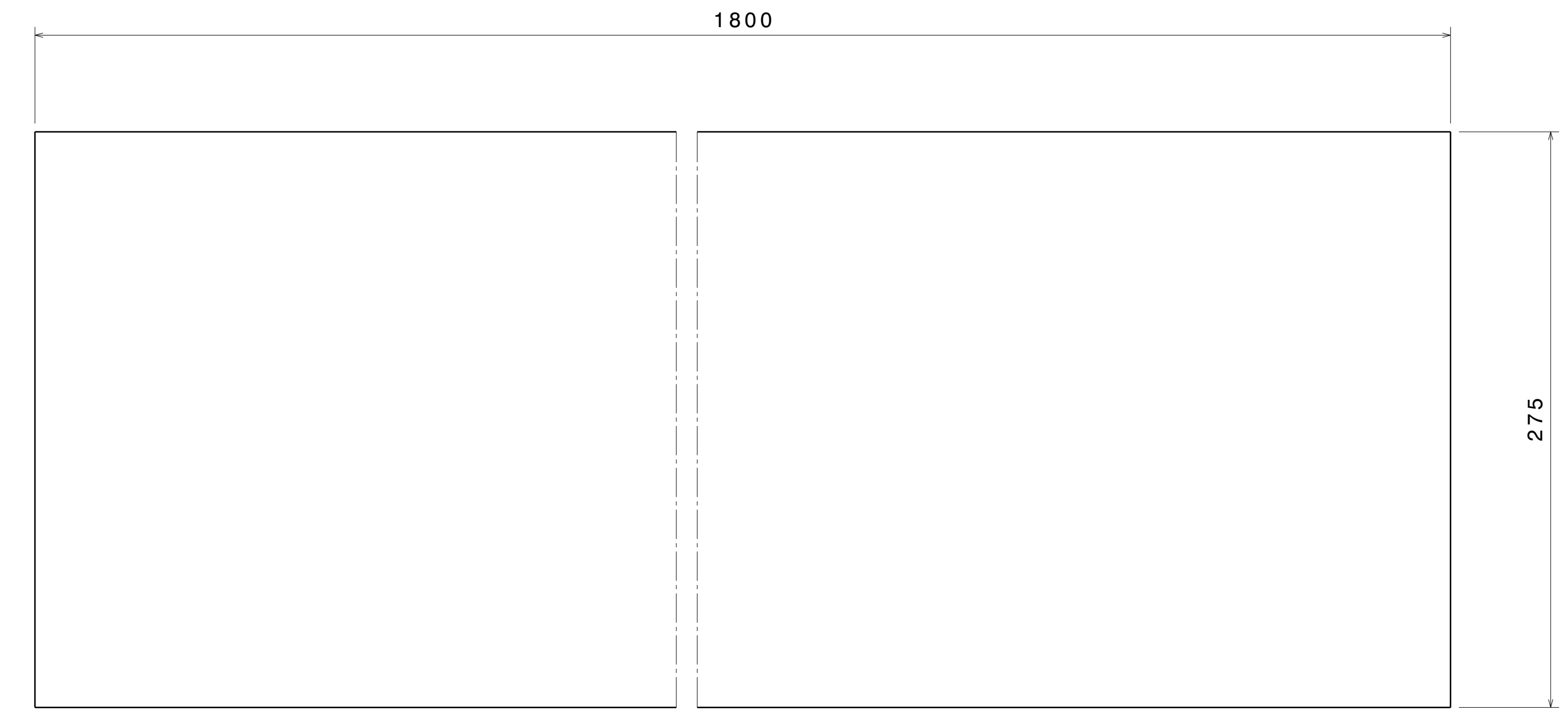

ITEM 6

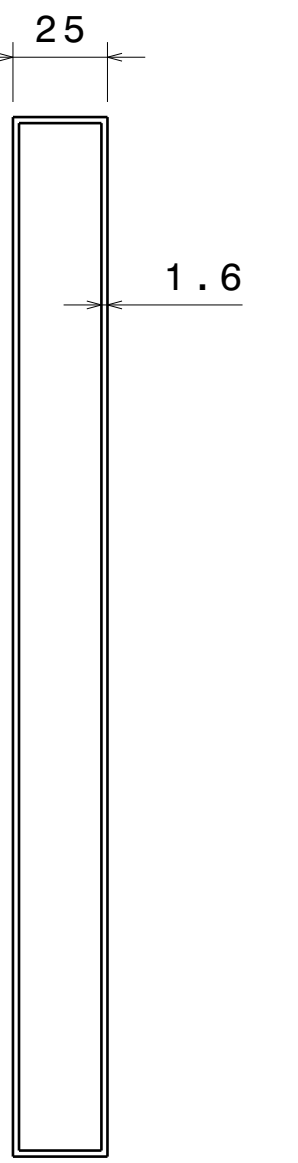

Right view
Scale: 1:2

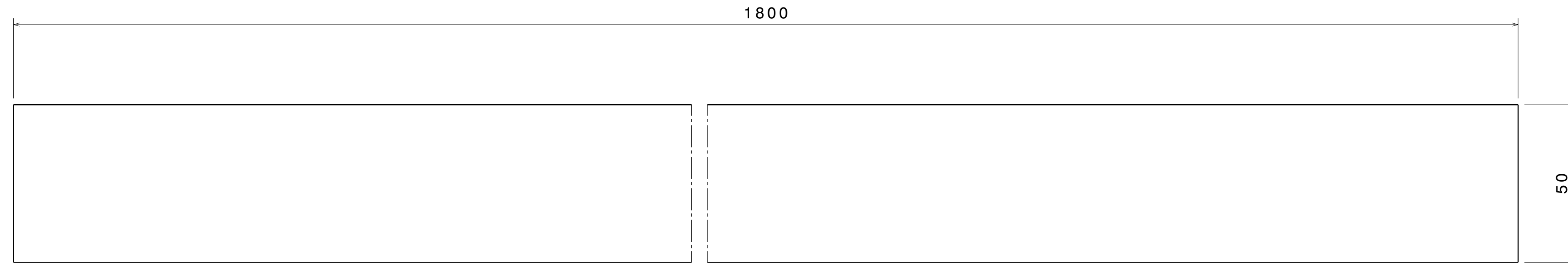

ITEM 2

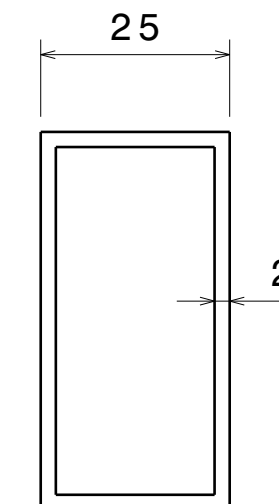

Right view[2]
Scale: 1:1

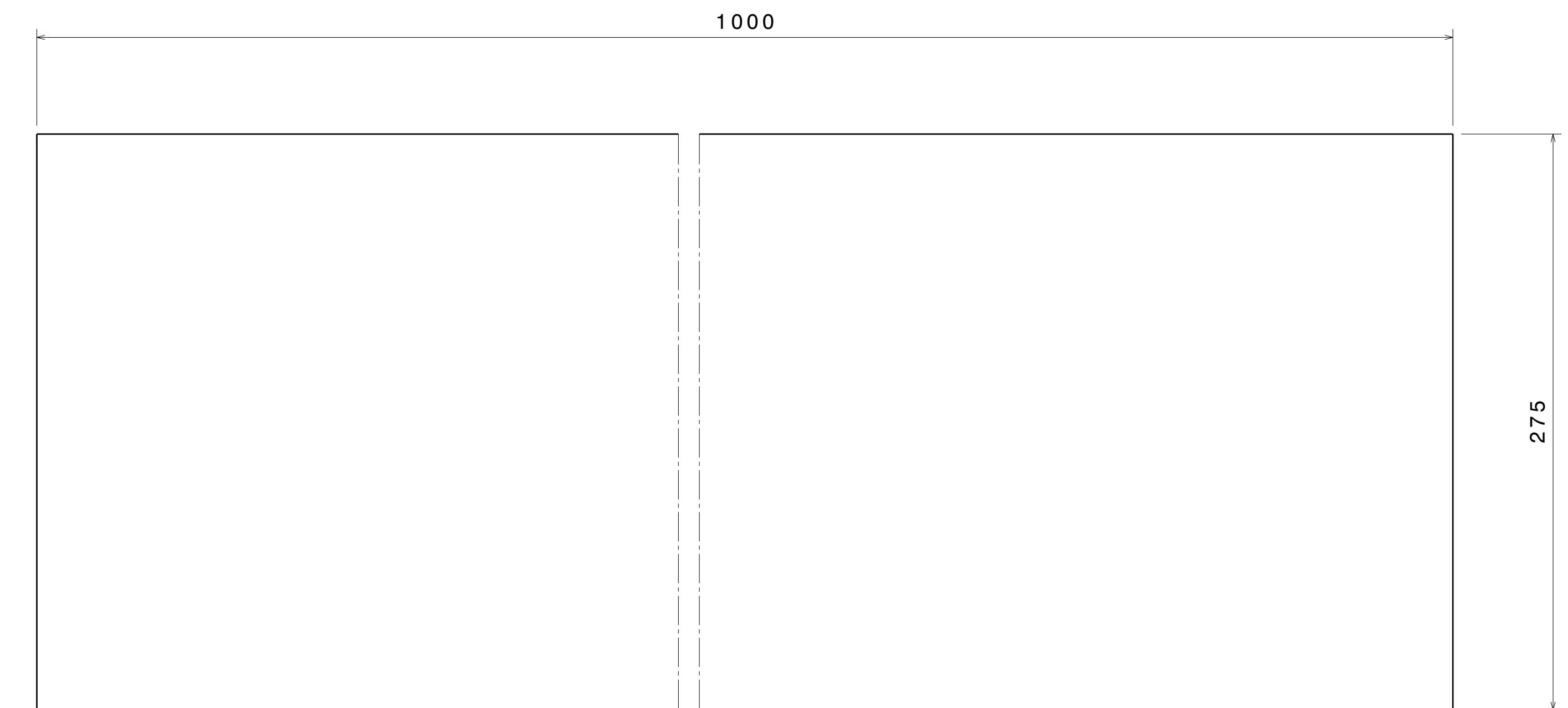

ITEM 7

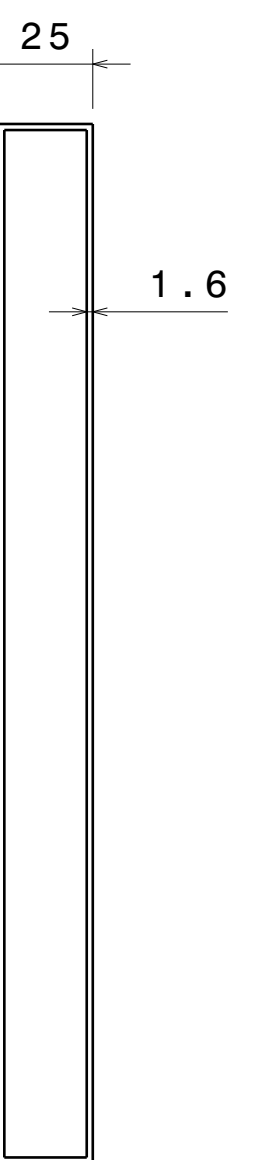

Right view[4]
Scale: 1:2

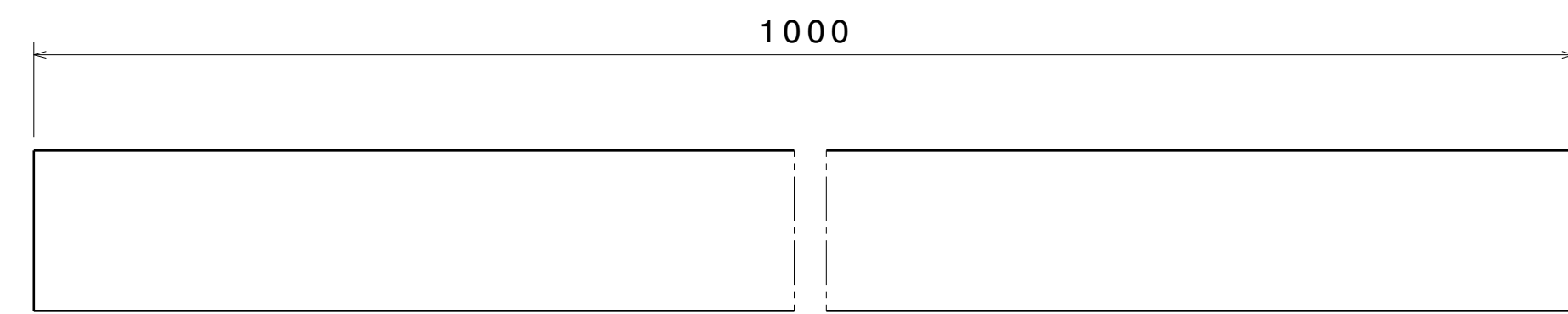

ITEM 3

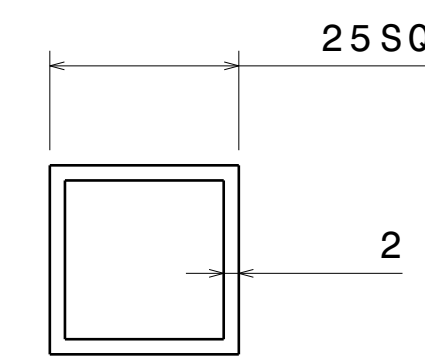

Right view
Scale: 1:1

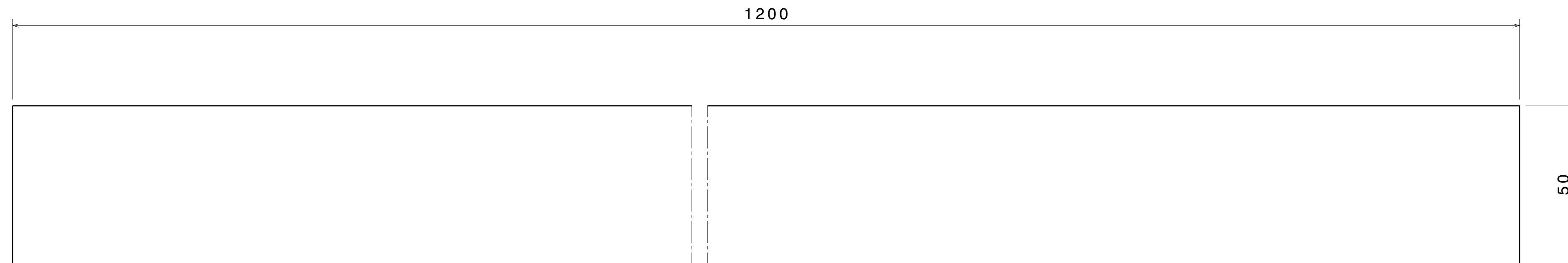

ITEM 4

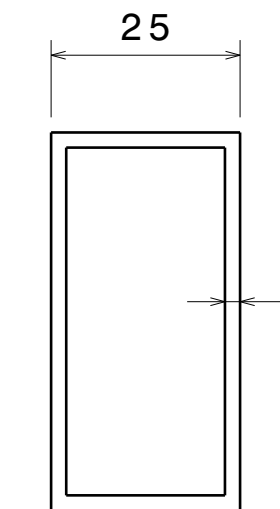

Right view[3]
Scale: 1:1

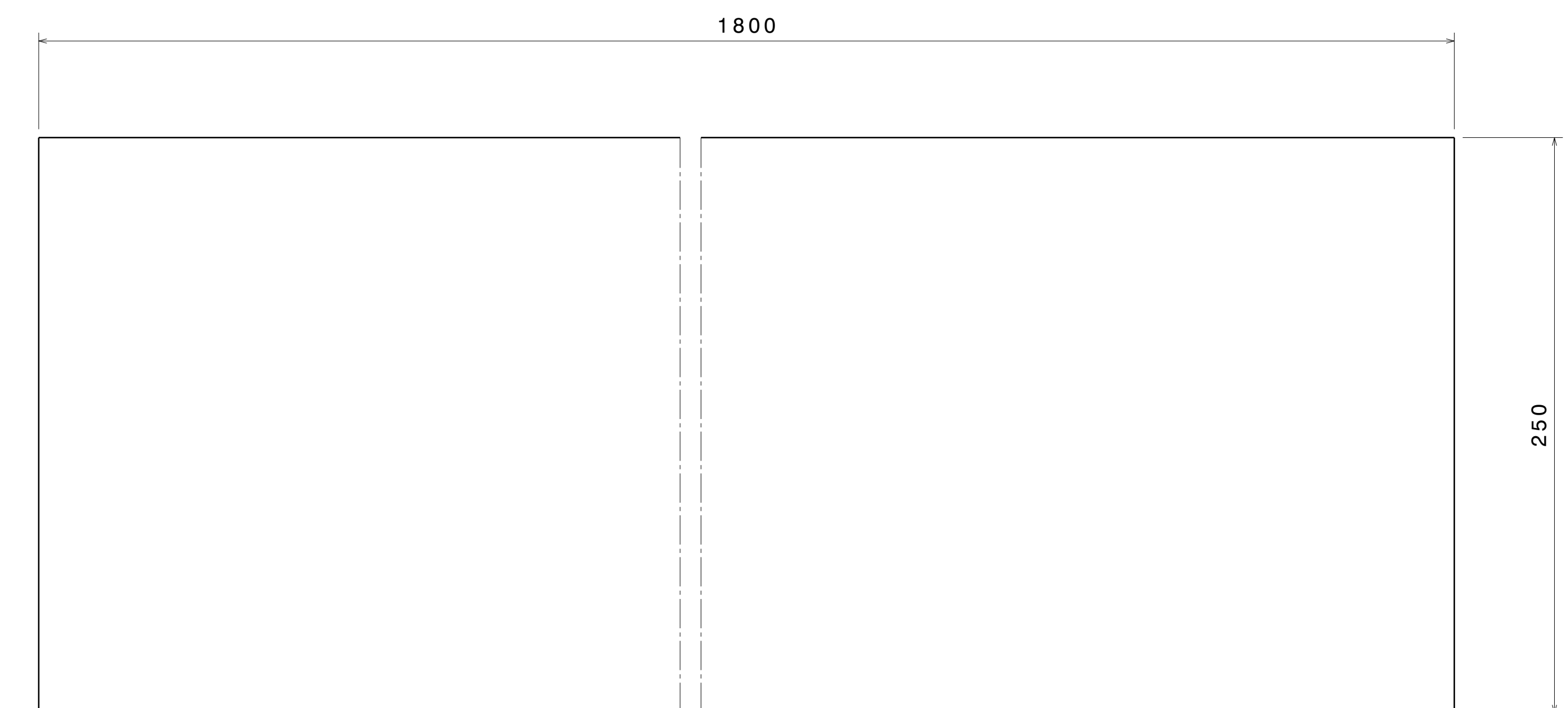

ITEM 8

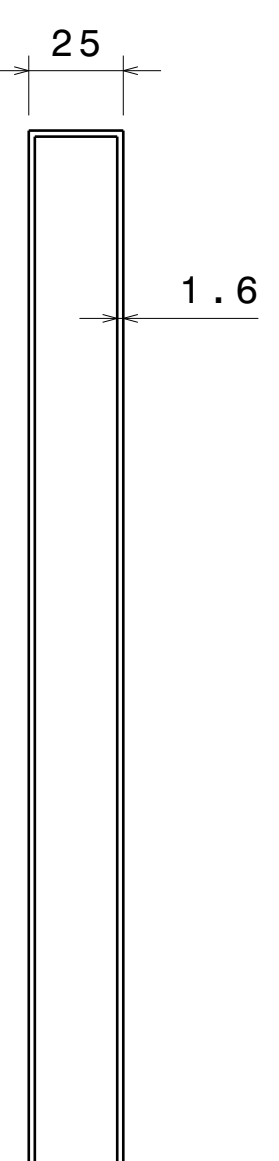

Right view[5]
Scale: 1:2

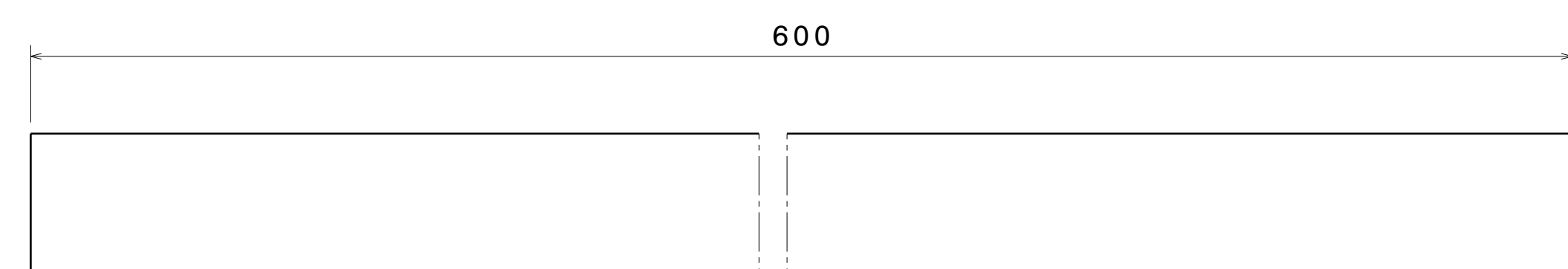

ITEM 5

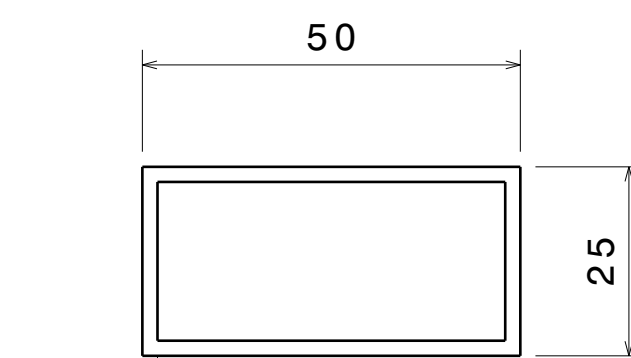

Right view
Scale: 1:1

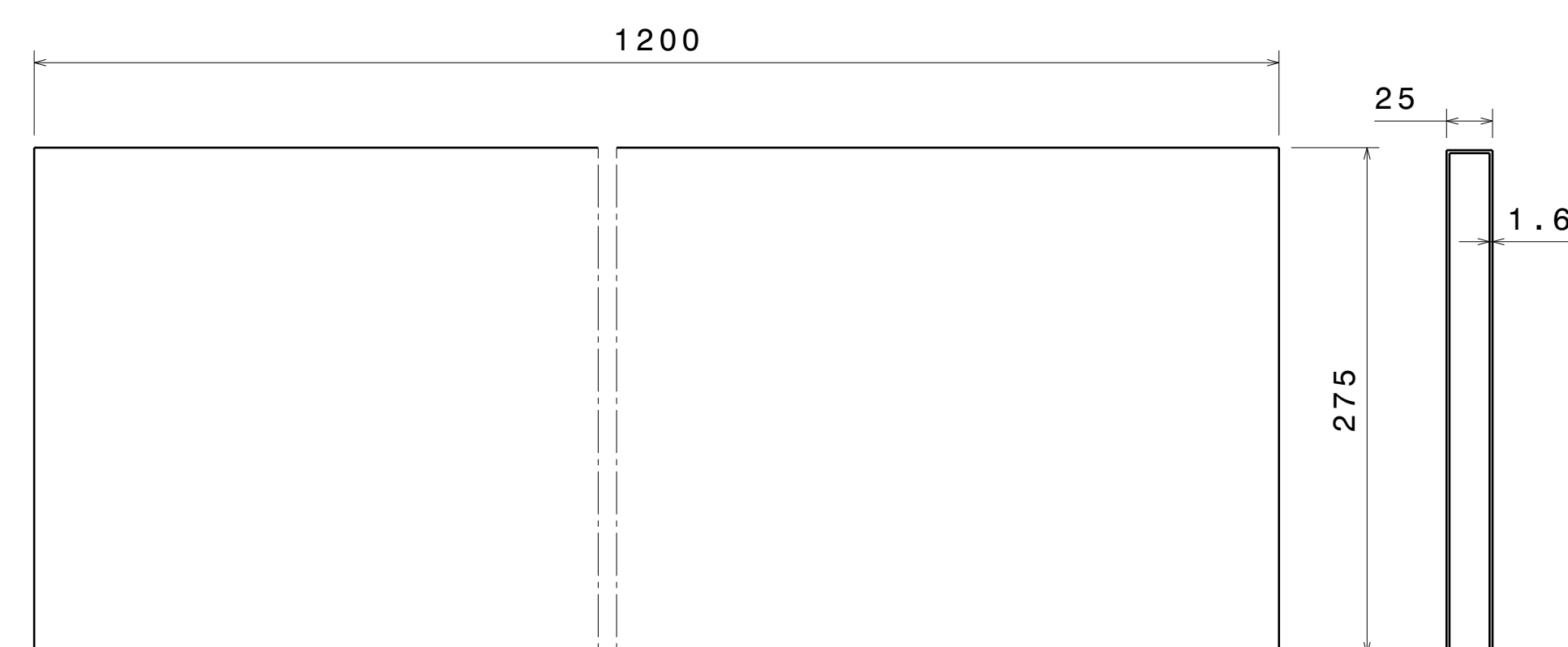

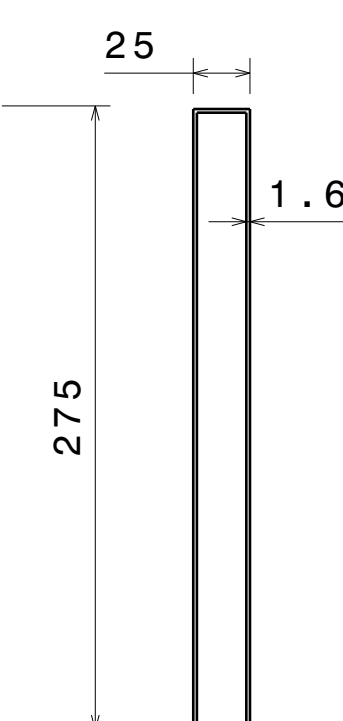

ITEM 9

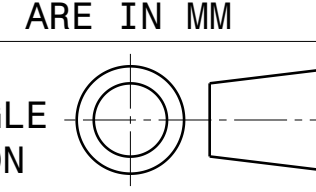

Right view[6]
Scale: 3:10

UNLESS OTHERWISE SPECIFIED DIMENSION ARE IN MM
VIEWS: THIRD ANGLE PROJECTION



This drawing is our property. It can't be reproduced or communicated without our written agreement.		APL APOLLO TUBES LTD. 	
DRAWN BY SB		DATE 24JAN2021	
CHECKED BY P2P Analysis & Solutions		DATE 24JAN2021	
DESIGNED BY P2P Analysis & Solutions		DATE 24JAN2021	
DRAWING TITLE JAN 21-16		SIZE A0	REV 00
DRAWING NUMBER JAN 21-16		SCALE NONE	WEIGHT (kg) XXX
SHEET 3 OF 3			