

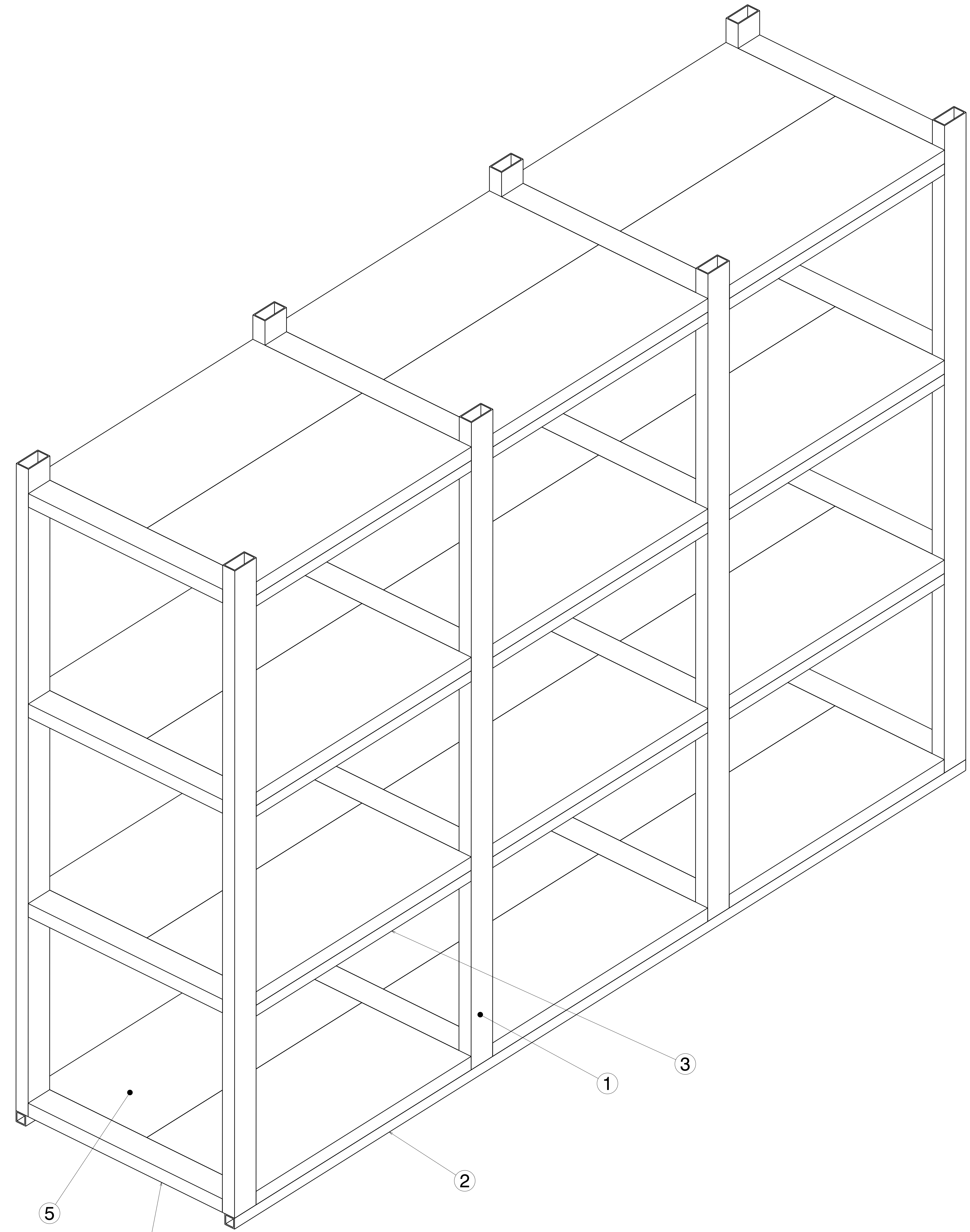

REV/DATE	DESCRIPTION
00 / 17JAN2021	INITIAL REVISION

- NOTES:
- (⊥) ALL VERTICAL SUPPORTS ARE PERPENDICULAR.
 - FLATNESS OF .5MM IS APPLIED BY DEFAULT.
 - ⊲ WELD BEAD OF 2MM RADIUS IS FOLLOWED.
 - ▽ SURFACE FINISH MEDIUM TO SMOOTH IS USED.
 - ALL TUBES ARE AS PER APL APOLLO STANDARD. CHANGES MAY EFFECT THE LOAD CAPACITY.
 - ALL HORIZONTAL AND VERTICAL TUBES ARE PERPENDICULAR TO EACH OTHER WITH ±1 DEG.
 - FINE WELDING IS REQUIRED AS PER MENTIONED DETAILS AND FINISHING.
 - HIGHER CURRENT WELDING MAY AFFECT THE BRITTLENESS OF MATERIAL WHICH LATER MAY RAISE TO WEAKENING OF STRUCTURE.
 - FABRICATORS ARE ALLOWED TO USE FITTINGS/FRAMES/SUPPORTS AS NEEDED AND THE SAME MUST BE COMMUNICATED BACK TO ENGINEERING TEAM.
 - BOP COMPONENT WEIGHTS ARE FOR REFERENCE ONLY AND SUBJECTED TO CHANGE PER PURCHASED COMPONENTS.



Isometric view

ITEM NO.	PART NUMBER	DESCRIPTION	QTY.	Wt (Kg)/Each
5	PLANK 1	225 X 25 X 1.6 X 500	24	3.1
4	RHS FRAME 4	50 X 25 X 2 X 400	16	0.89
3	RHS FRAME 3	20 X 20 X 2 X 500	18	0.93
2	RHS FRAME 2	20 X 20 X 2 X 1700	2	1.92
1	RHS FRAME 1	50 X 25 X 2 X 1200	8	2.68

This drawing is our property. It can't be reproduced or communicated without our written agreement.		APL APOLLO TUBES LTD. 	
DRAWN BY: SB		DATE: 17JAN2021	
CHECKED BY: P2P Analysis & Solutions		DATE: 17JAN2021	
DESIGNED BY: P2P Analysis & Solutions		DATE: 17JAN2021	
DRAWING TITLE: JAN21-20		REV: 00	
SIZE: A0		DRAWING NUMBER: P2P JAN21-20	
SCALE: As Indicated		WEIGHT (kg): 0kg	
		SHEET 1 OF 3	

UNLESS OTHERWISE SPECIFIED DIMENSION ARE IN MM VIEWS: THIRD ANGLE PROJECTION

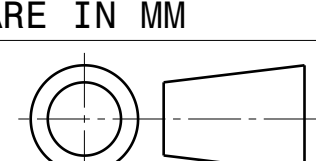

REV	DATE	DESCRIPTION
00	17JAN2021	INITIAL REVISION



Top view
Scale: 7:20

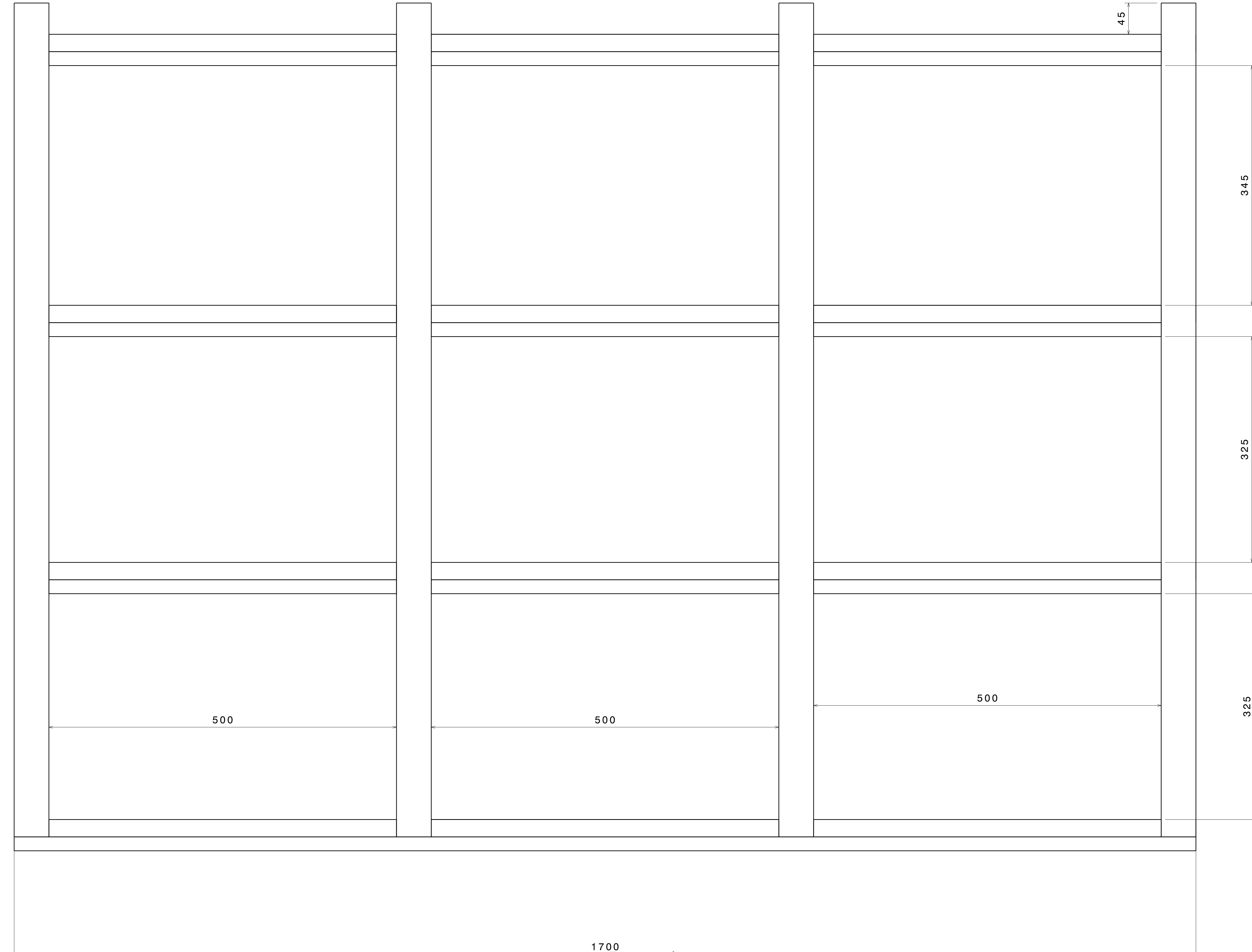

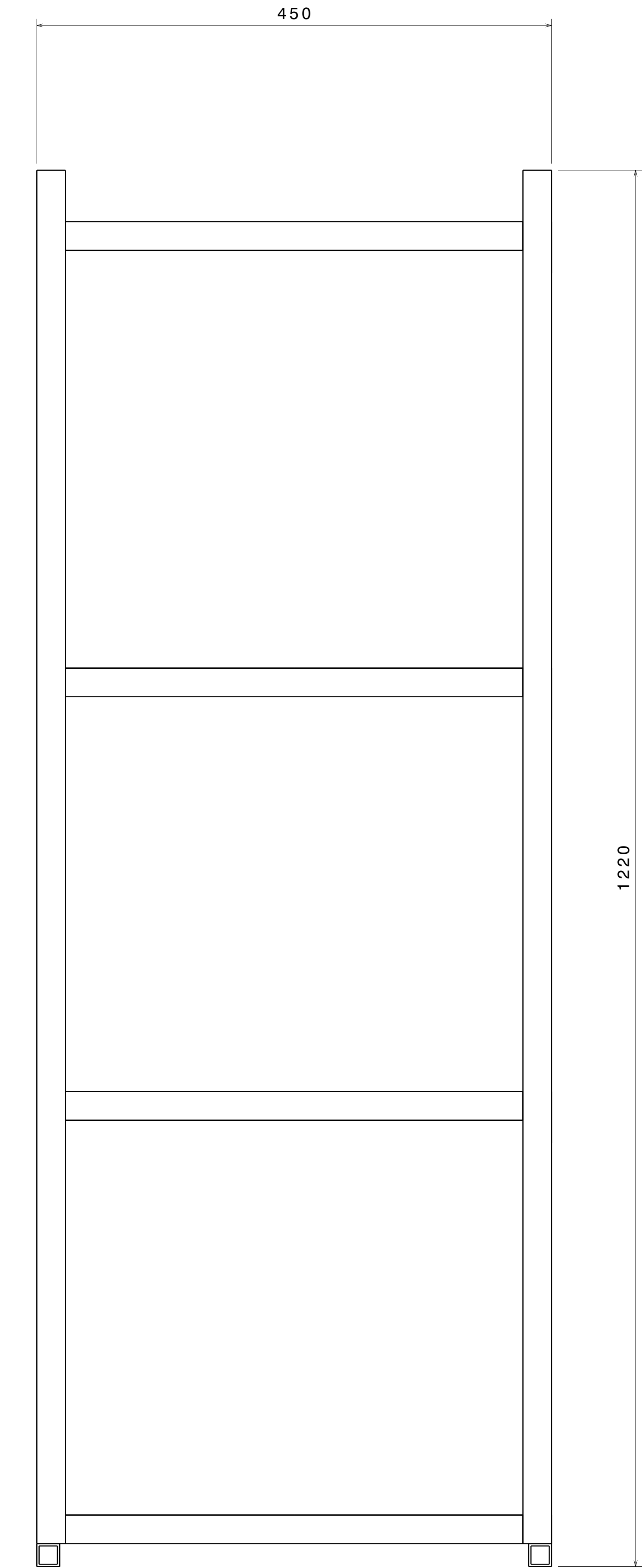

1700
Front view
Scale: 7:20

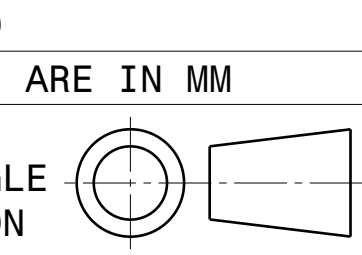

Right view
Scale: 7:20

UNLESS OTHERWISE SPECIFIED DIMENSION ARE IN MM
VIEWS: THIRD ANGLE PROJECTION



This drawing is our property. It can't be reproduced or communicated without our written agreement.		APL APOLLO TUBES LTD. 	
DRAWN BY SB		DATE 17JAN2021	
CHECKED BY P2P Analysis & Solutions		DATE 17JAN2021	
DESIGNED BY P2P Analysis & Solutions		DATE 17JAN2021	
DRAWING TITLE JAN21-20		SIZE A0	REV 00
DRAWING NUMBER P2P JAN21-20		SCALE NONE	WEIGHT (kg) XXX
SHEET 2 OF 3			

REV	DATE	DESCRIPTION
00	17JAN2021	INITIAL REVISION

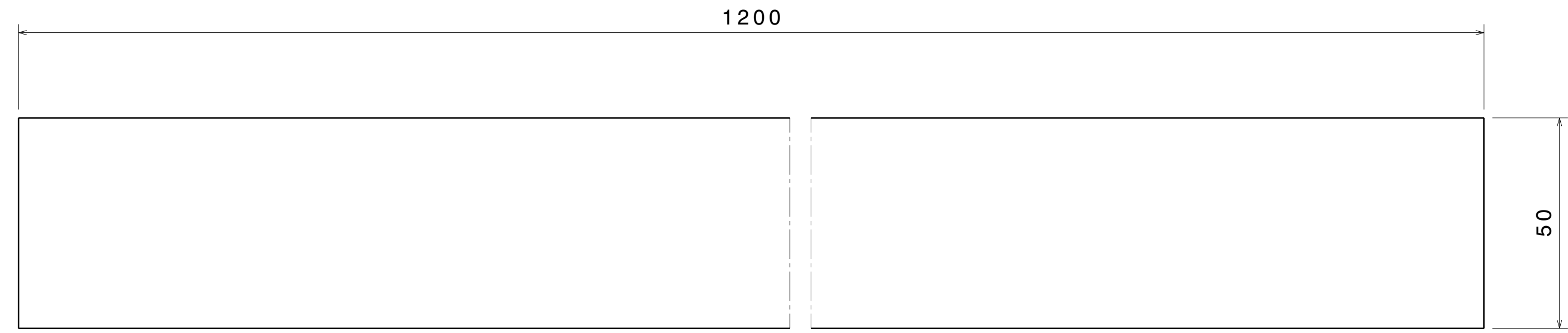

ITEM 1

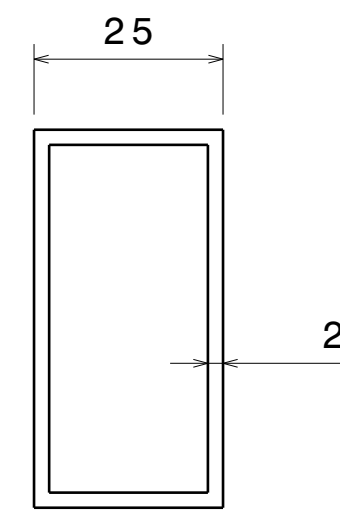

Right view
Scale: 1:1

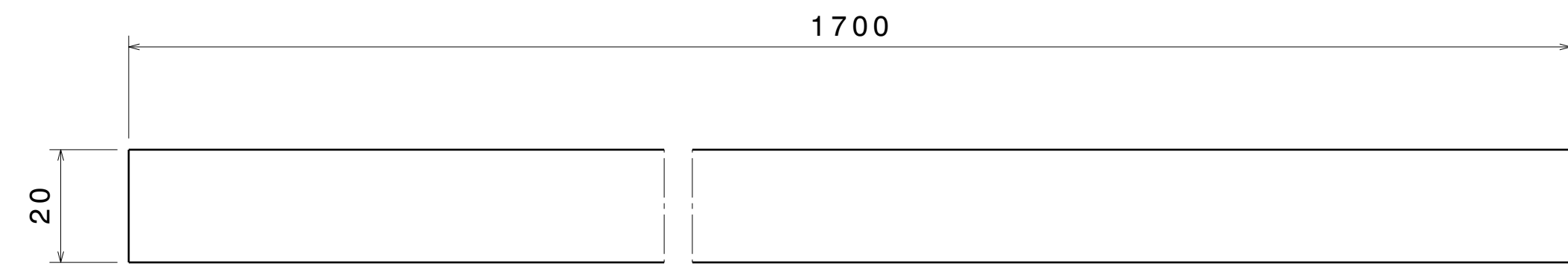

ITEM 2

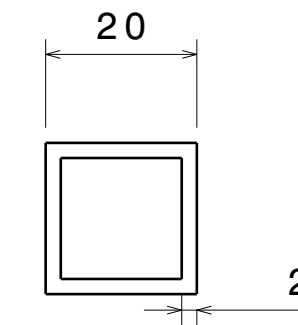

Right view
Scale: 1:1

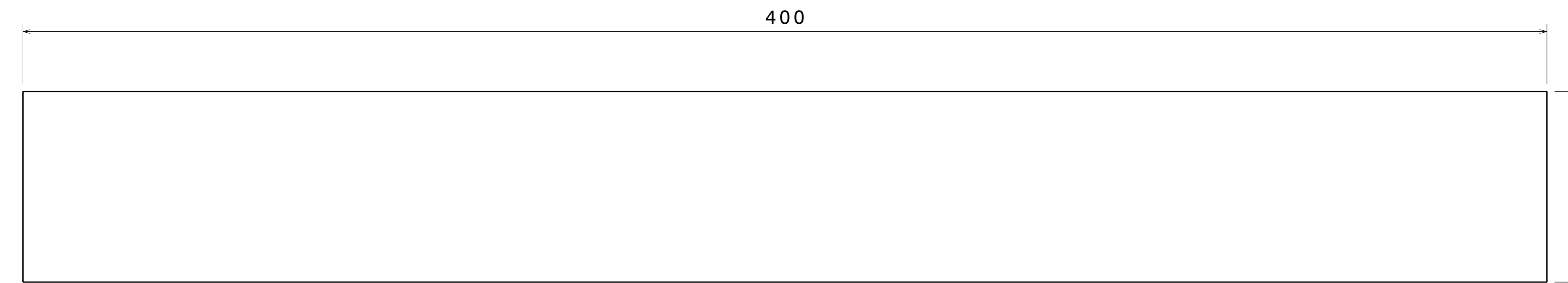

ITEM 4

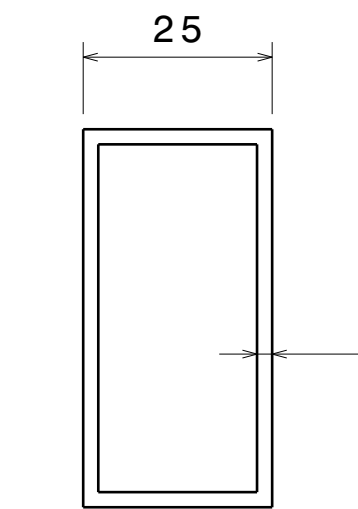

Right view
Scale: 1:1



ITEM 3

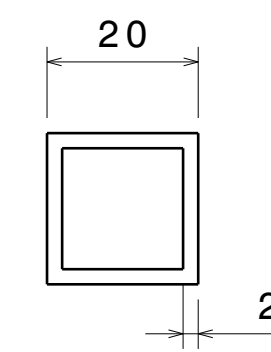

Right view
Scale: 1:1



ITEM 5

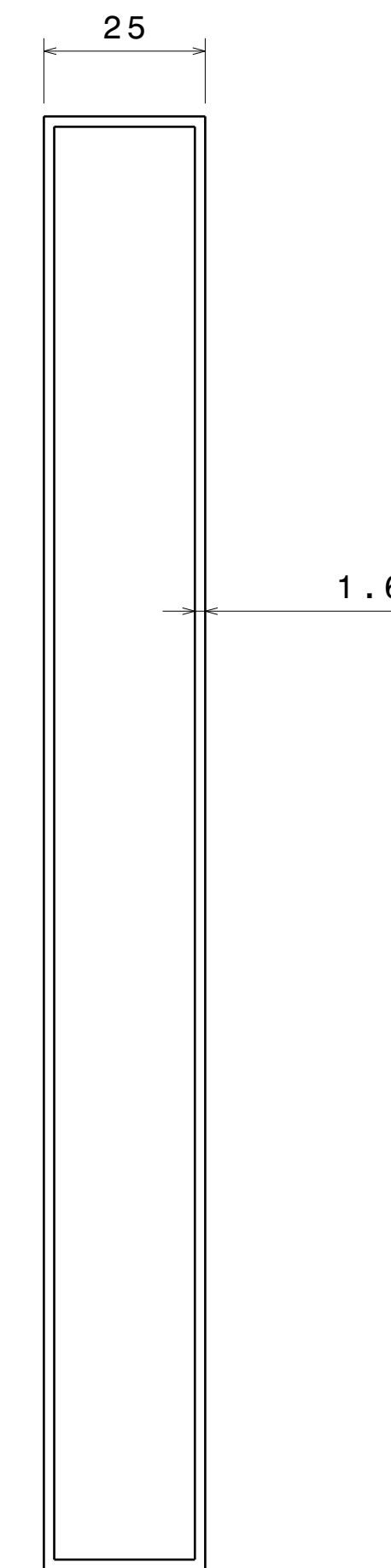

Right view
Scale: 1:1

UNLESS OTHERWISE SPECIFIED DIMENSION ARE IN MM
VIEWS: THIRD ANGLE PROJECTION

This drawing is our property. It can't be reproduced or communicated without our written agreement.		APL APOLLO TUBES LTD.	
DRAWN BY SB		DATE 17JAN2021	
CHECKED BY P2P Analysis & Solutions		DATE 17JAN2021	
DESIGNED BY P2P Analysis & Solutions		DATE 17JAN2021	
DRAWING TITLE JAN21-20		SIZE A0	DRAWING NUMBER P2P JAN21-20
SCALE NONE		WEIGHT (kg) XXX	REV 00
		SHEET 3 OF 3	