

REV/DATE	DESCRIPTION
00 24MAR2021	INITIAL REVISION

- NOTES:
- (⊥) ALL VERTICAL SUPPORTS ARE PERPENDICULAR.
 - FLATNESS OF .5MM IS APPLIED BY DEFAULT.
 - ⊲ WELD BEAD OF 2MM RADIUS IS FOLLOWED.
 - ▽▽ SURFACE FINISH MEDIUM TO SMOOTH IS USED.
 - ALL TUBES ARE AS PER APL APOLLO STANDARD. CHANGES MAY EFFECT THE LOAD CAPACITY.
 - ALL HORIZONTAL AND VERTICAL TUBES ARE PERPENDICULAR TO EACH OTHER WITH ±1 DEG.
 - FINE WELDING IS REQUIRED AS PER MENTIONED DETAILS AND FINISHING.
 - HIGHER CURRENT WELDING MAY AFFECT THE BRITTLENESS OF MATERIAL WHICH LATER MAY RAISE TO WEAKENING OF STRUCTURE.
 - FABRICATORS ARE ALLOWED TO USE FITTINGS/FRAMES/SUPPORTS AS NEEDED AND THE SAME MUST BE COMMUNICATED BACK TO ENGINEERING TEAM.
 - BOP COMPONENT WEIGHTS ARE FOR REFERENCE ONLY AND SUBJECTED TO CHANGE PER PURCHASED COMPONENTS.

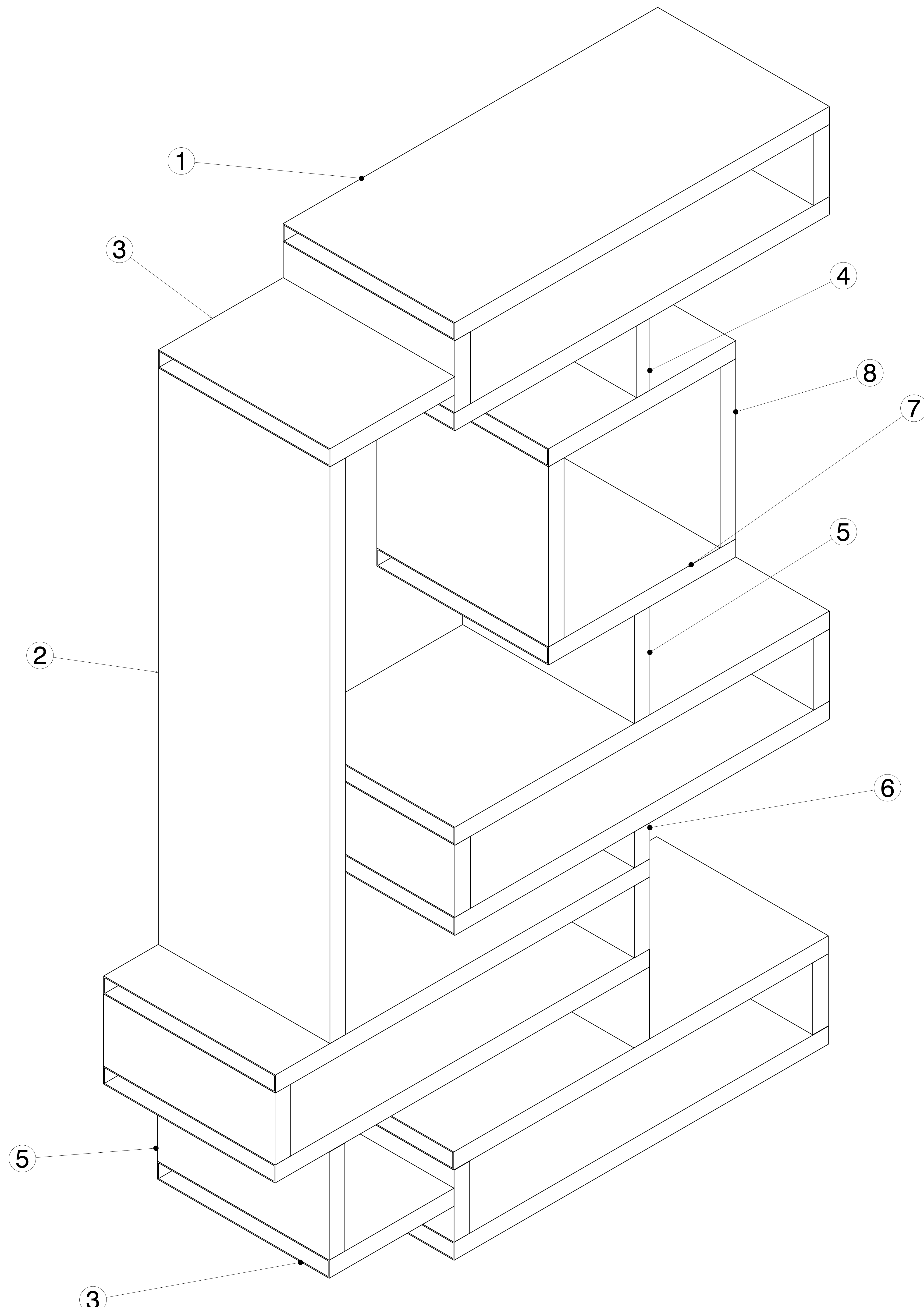

Isometric view
Scale: 1:2

ITEM NO.	PART NUMBER	DESCRIPTION	QTY.	Wt (Kg) /Each
8	PLANK 8	275 X 25 X 1.6 X 250	2	1.9
7	PLANK 7	275 X 25 X 1.6 X 300	2	1.76
6	PLANK 6	275 X 25 X 1.6 X 50	1	0.38
5	PLANK 5	275 X 25 X 1.6 X 150	2	0.88
4	PLANK 4	275 X 25 X 1.6 X 100	10	0.75
3	PLANK 3	275 X 25 X 1.6 X 200	2	1.5
2	PLANK 2	275 X 25 X 1.6 X 800	1	5.97
1	PLANK 1	275 X 25 X 1.6 X 600	8	4.48

This drawing is our property. It can't be reproduced or communicated without our written agreement.		APL APOLLO TUBES LTD.	
DRAWN BY SB		DATE 24MAR2021	
CHECKED BY P2P Analysis & Solutions		DATE 24MAR2021	
DESIGNED BY P2P Analysis & Solutions		DATE 24MAR2021	
DRAWING TITLE WALL SHELF		SIZE A0	DRAWING NUMBER P2P MAR 21-03
SCALE As Indicated		WEIGHT (kg) 0kg	REV 00
		SHEET 1 OF 3	

UNLESS OTHERWISE SPECIFIED DIMENSION ARE IN MM
VIEWS: THIRD ANGLE PROJECTION

REV	DATE	DESCRIPTION
00	24MAR2021	INITIAL REVISION

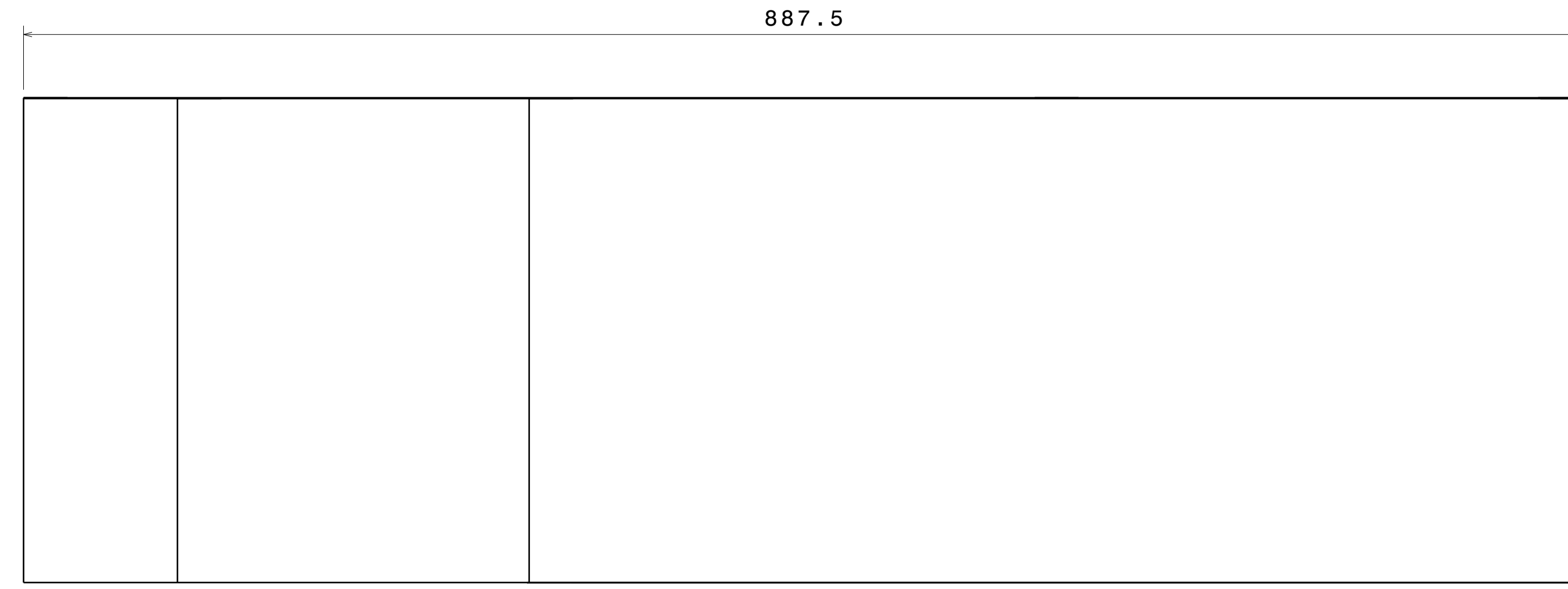

Top view
Scale: 2:5

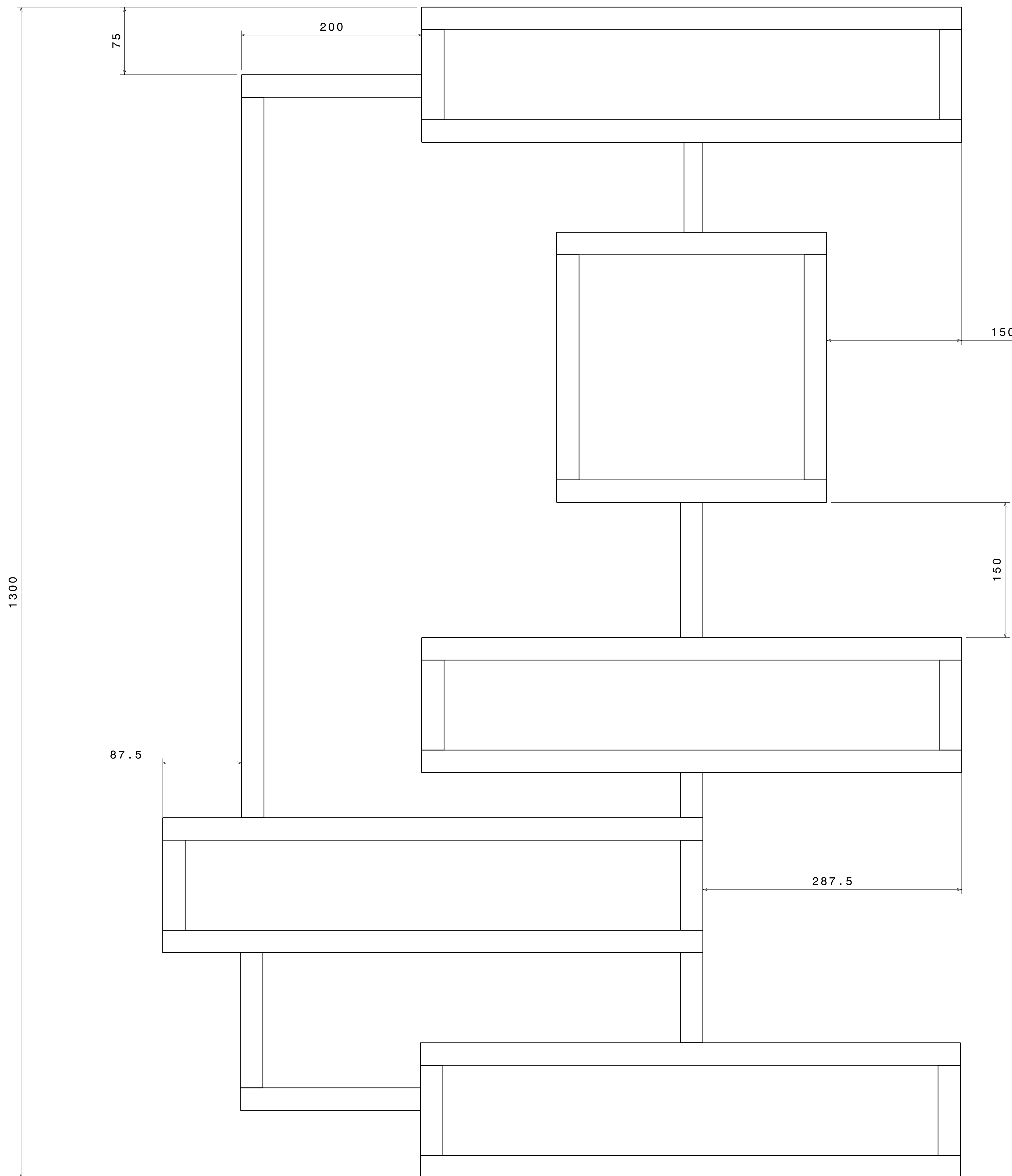

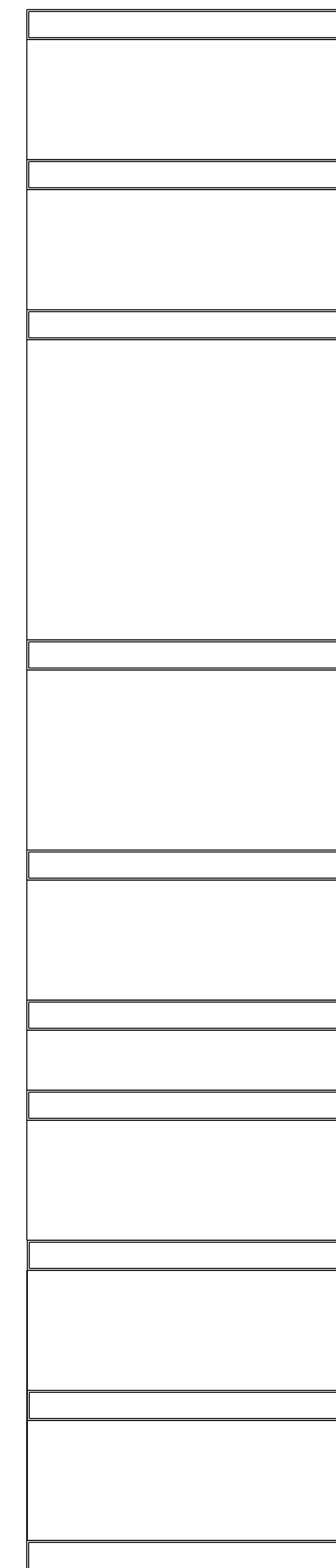

Front view
Scale: 2:5

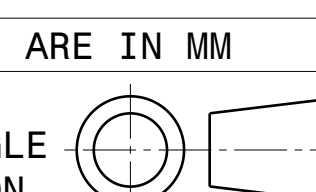

Right view
Scale: 2:5

UNLESS OTHERWISE SPECIFIED DIMENSION ARE IN MM
VIEWS: THIRD ANGLE PROJECTION



This drawing is our property. It can't be reproduced or communicated without our written agreement.		APL APOLLO TUBES LTD. 	
DRAWN BY SB		DRAWING TITLE WALL SHELF	
CHECKED BY P2P Analysis & Solutions	DATE 24MAR2021	SIZE A0	REV 00
DESIGNED BY P2P Analysis & Solutions	DATE 24MAR2021	SCALE NONE	WEIGHT (kg) XXX
		SHEET 2 OF 3	

REV	DATE	DESCRIPTION
00	24MAR2021	INITIAL REVISION

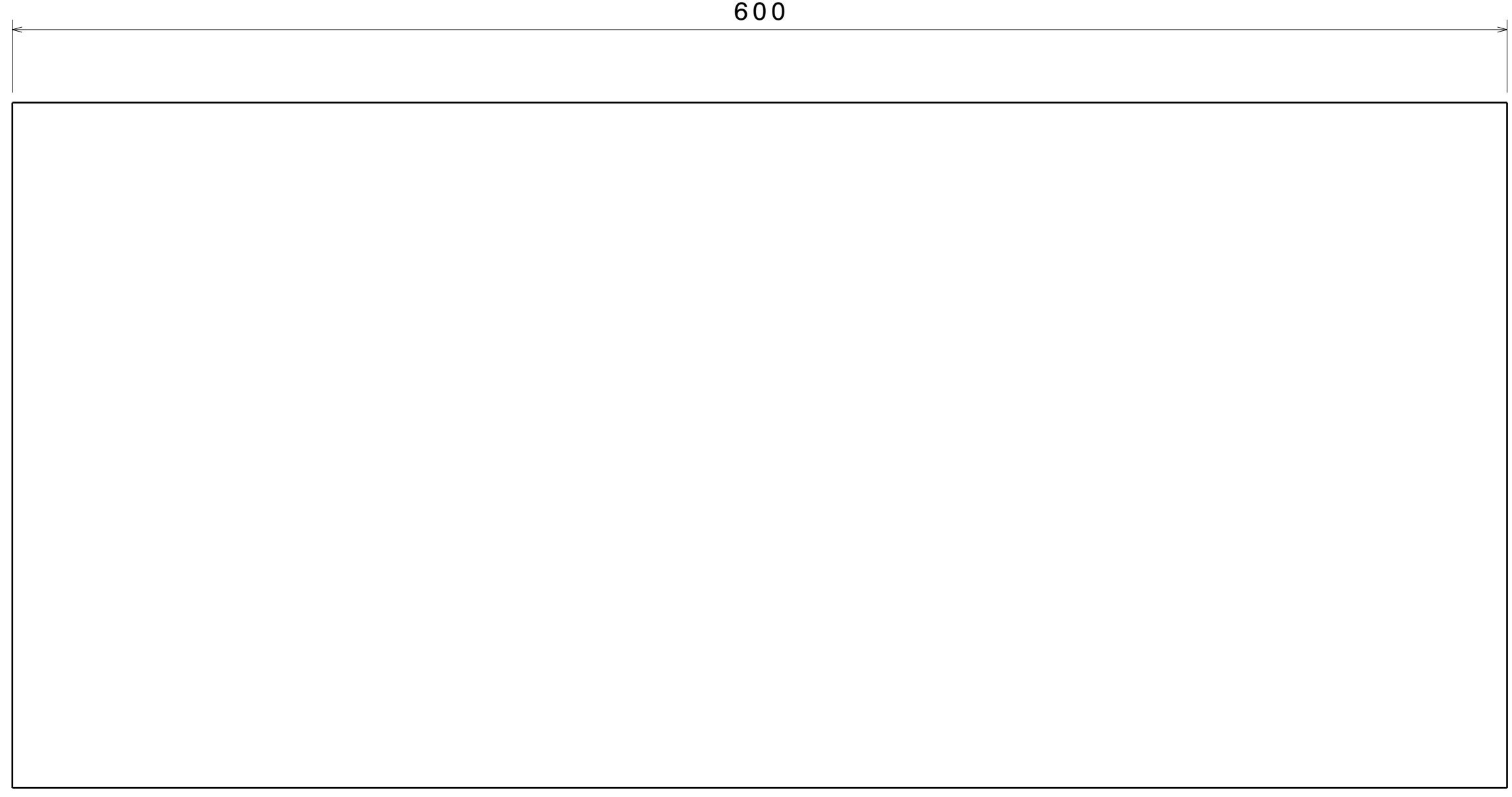

ITEM 1

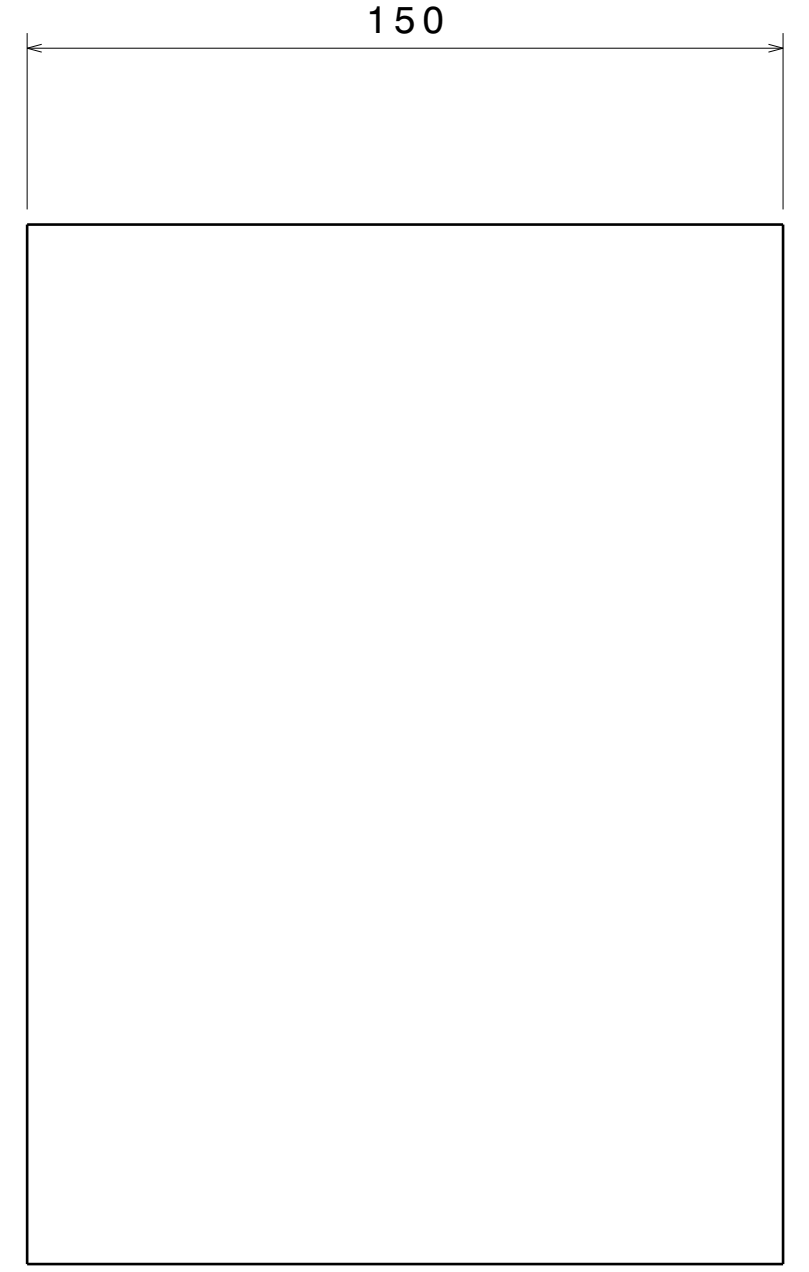

ITEM 5

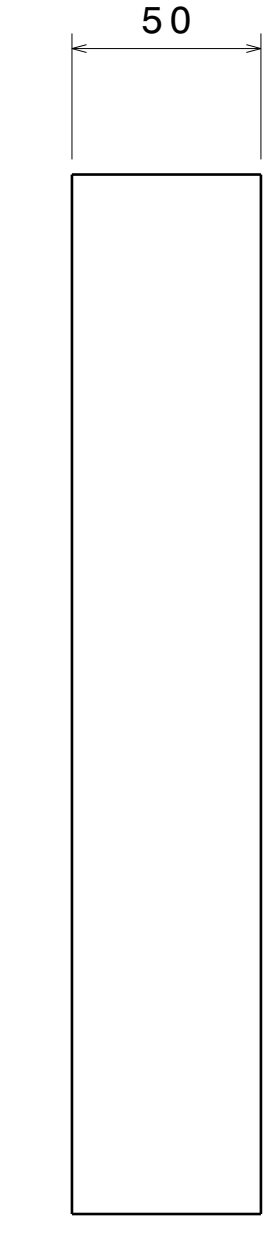

ITEM 6

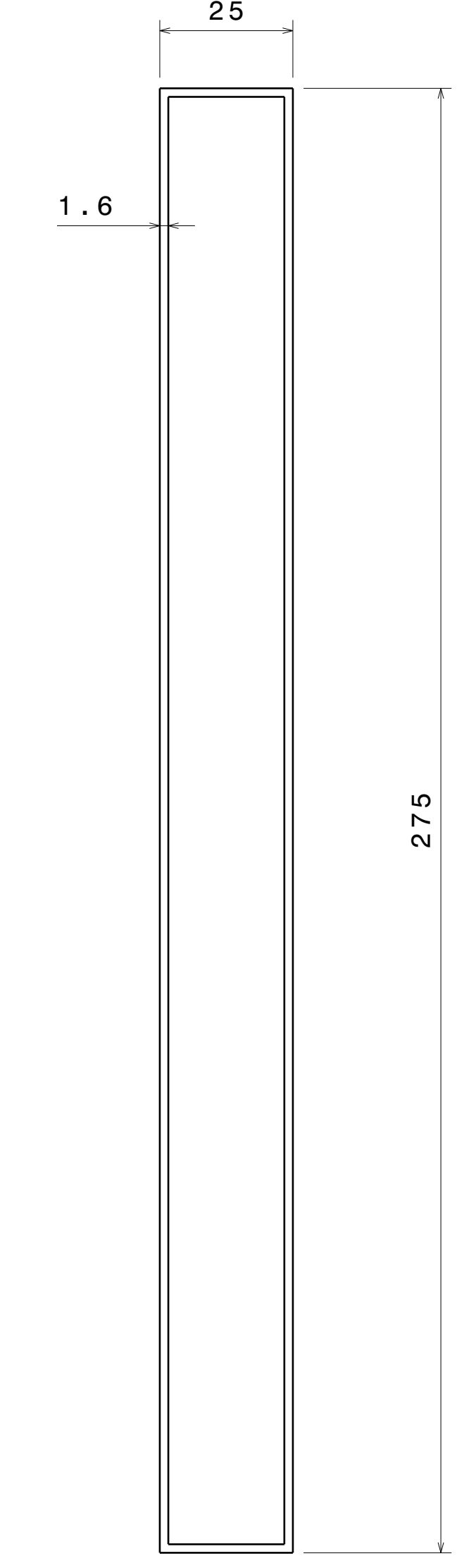

TYPICAL

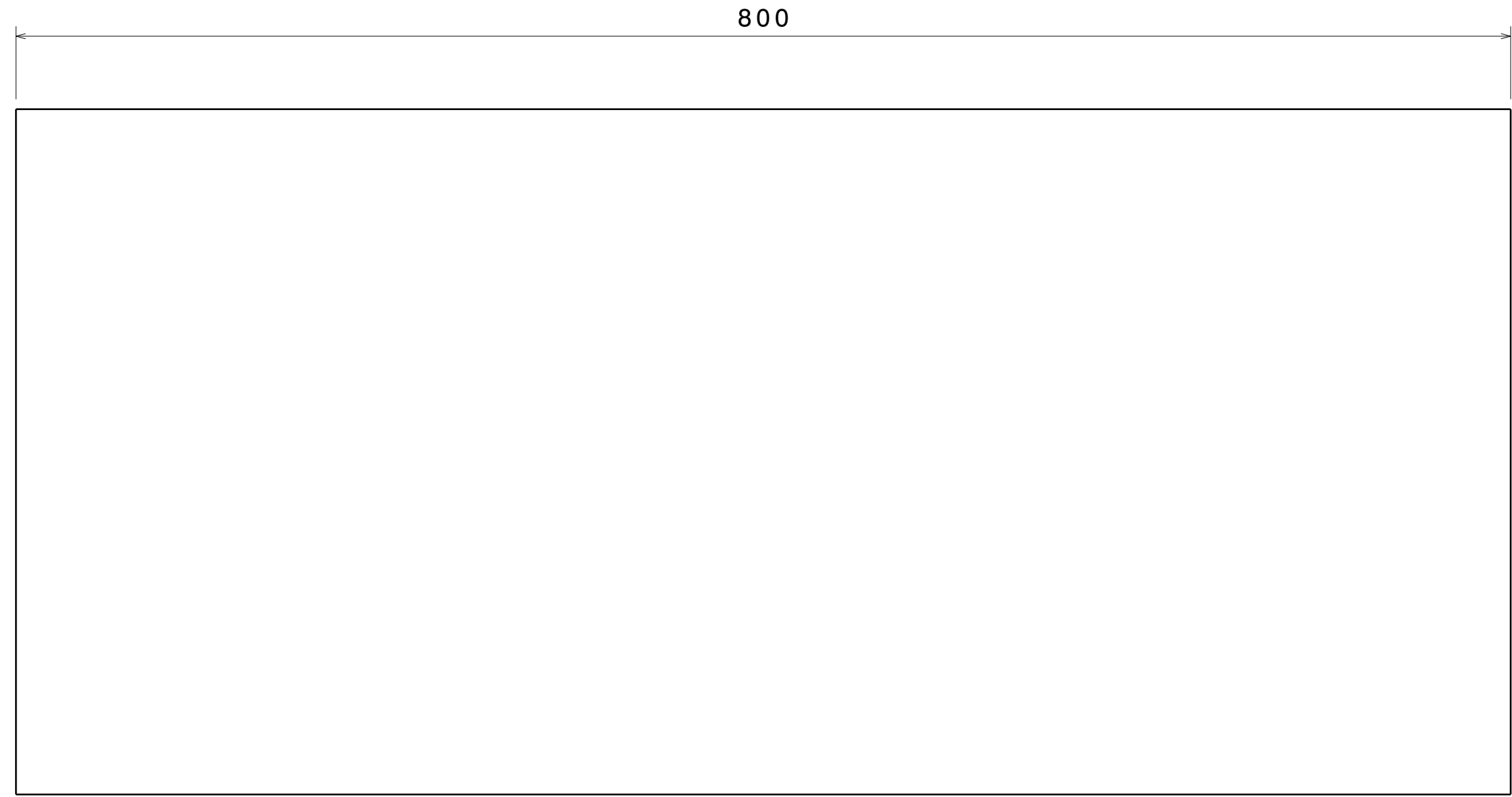

ITEM 2

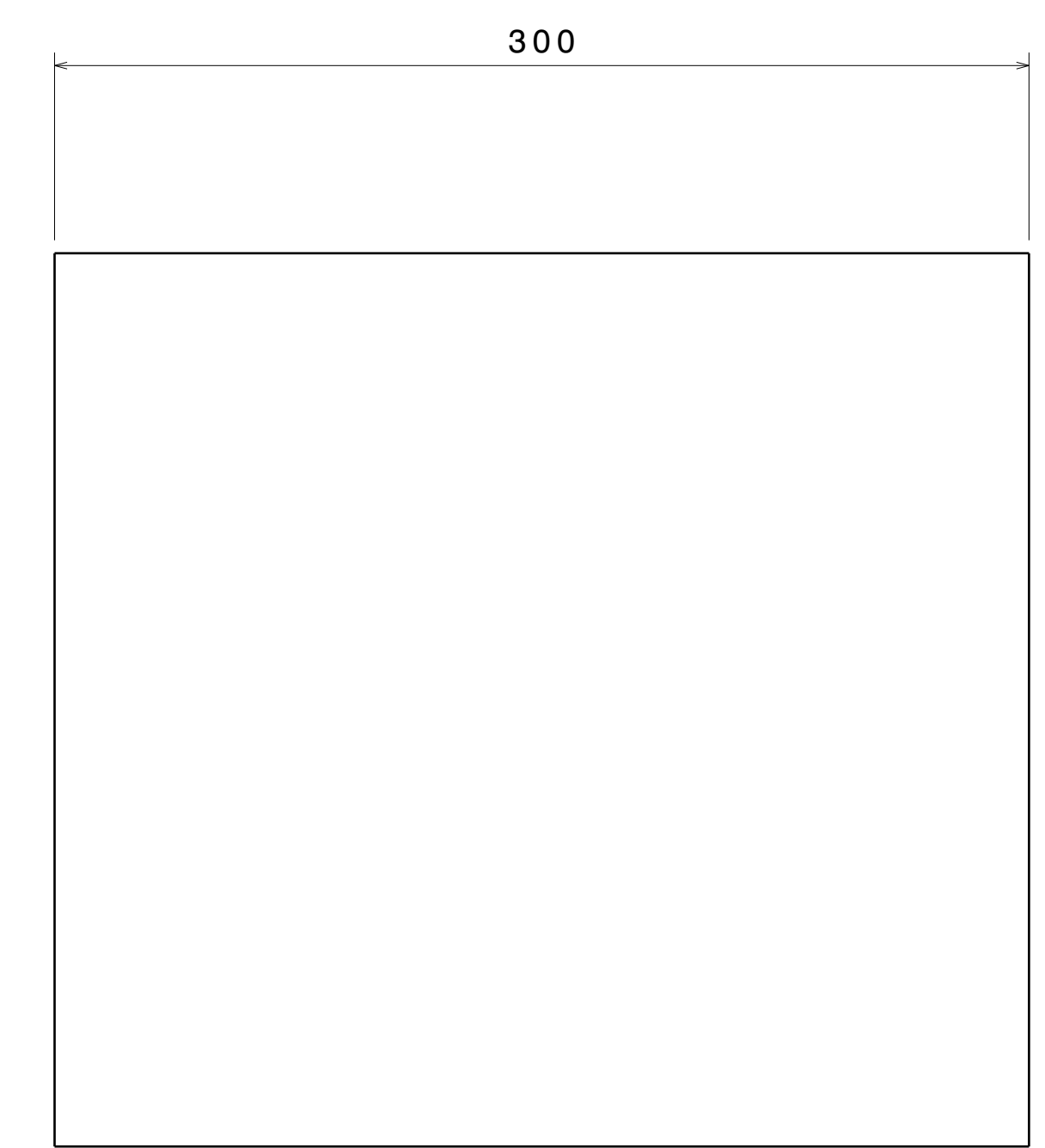

ITEM 7

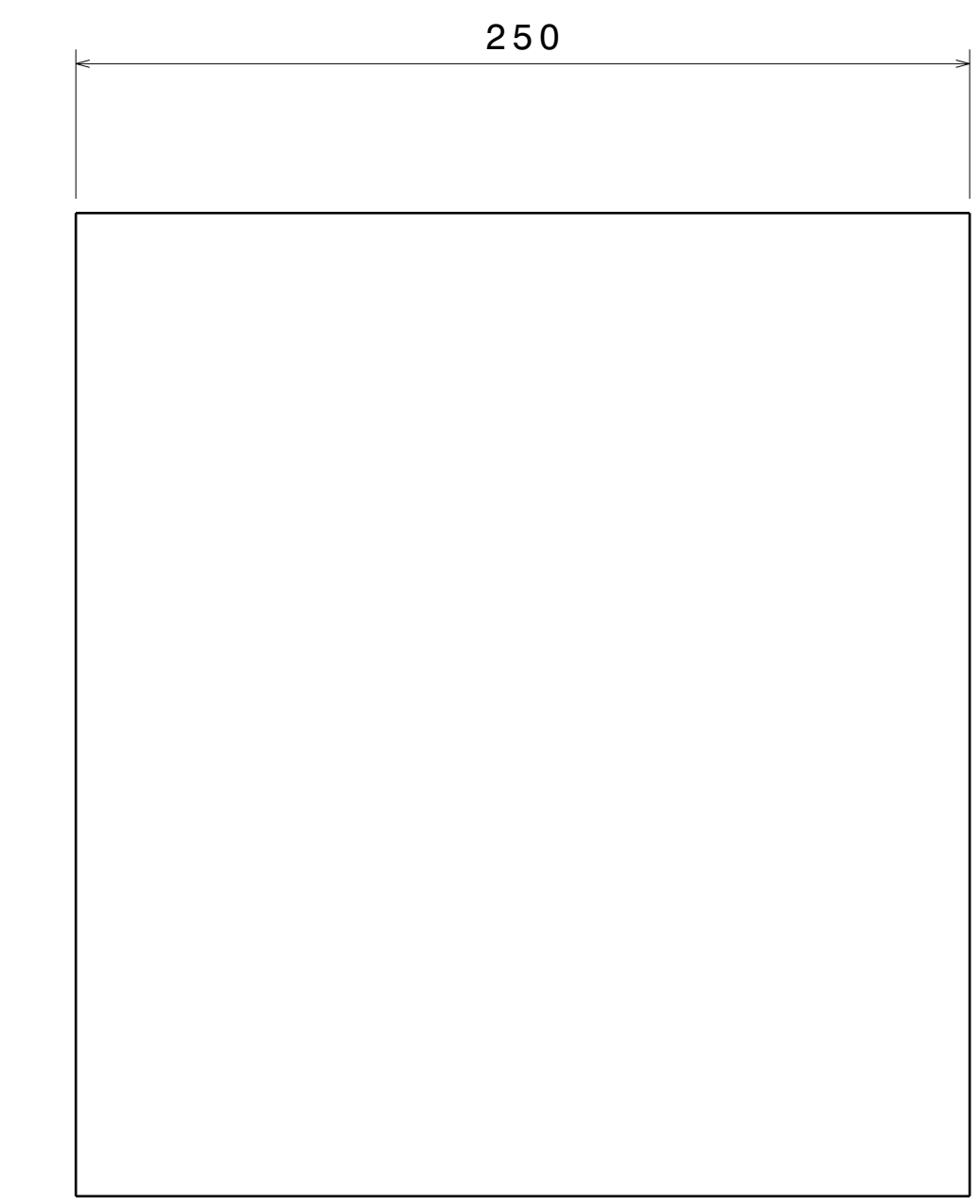

ITEM 8

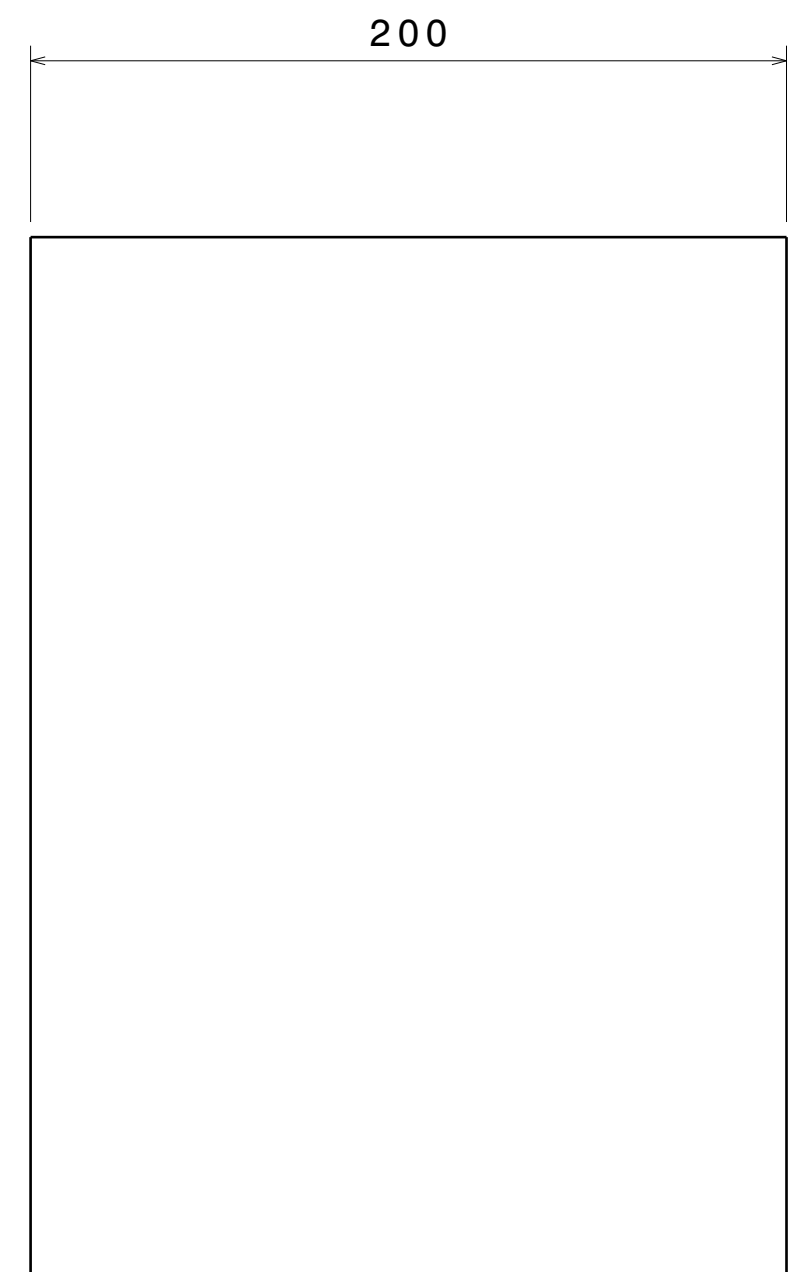

ITEM 3

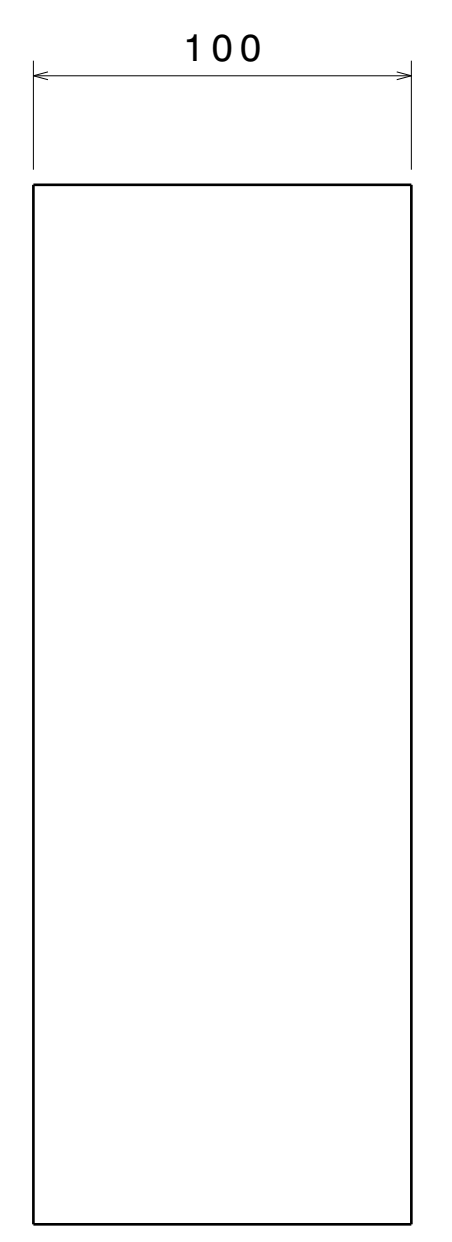

ITEM 4

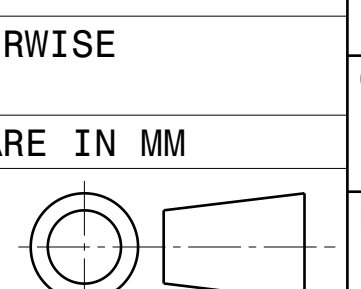
This drawing is our property. It can't be reproduced or communicated without our written agreement.		APL APOLLO TUBES LTD. 	
DRAWN BY SB		DATE 24MAR2021	
CHECKED BY P2P Analysis & Solutions		DATE 24MAR2021	
DESIGNED BY P2P Analysis & Solutions		DATE 24MAR2021	
UNLESS OTHERWISE SPECIFIED DIMENSION ARE IN MM	THIRD ANGLE PROJECTION 	DRAWING TITLE WALL SHELF	
SCALE	NONE	WEIGHT (kg)	XXX
SHEET 3 OF 3		REV	00

UNLESS OTHERWISE SPECIFIED DIMENSION ARE IN MM
THIRD ANGLE PROJECTION 