

REV/DATE	DESCRIPTION
00 / 26MAR2021	INITIAL REVISION

NOTES:

- (⊥) ALL VERTICAL SUPPORTS ARE PERPENDICULAR.
- FLATNESS OF .5MM IS APPLIED BY DEFAULT.
- ⊲ WELD BEAD OF 2MM RADIUS IS FOLLOWED.
- ▽▽ SURFACE FINISH MEDIUM TO SMOOTH IS USED.
- ALL TUBES ARE AS PER APL APOLLO STANDARD. CHANGES MAY EFFECT THE LOAD CAPACITY.
- ALL HORIZONTAL AND VERTICAL TUBES ARE PERPENDICULAR TO EACH OTHER WITH ±1 DEG.
- FINE WELDING IS REQUIRED AS PER MENTIONED DETAILS AND FINISHING.
- HIGHER CURRENT WELDING MAY AFFECT THE BRITTLENESS OF MATERIAL WHICH LATER MAY RAISE TO WEAKENING OF STRUCTURE.
- FABRICATORS ARE ALLOWED TO USE FITTINGS/FRAMES/SUPPORTS AS NEEDED AND THE SAME MUST BE COMMUNICATED BACK TO ENGINEERING TEAM.
- BOP COMPONENT WEIGHTS ARE FOR REFERENCE ONLY AND SUBJECTED TO CHANGE PER PURCHASED COMPONENTS.

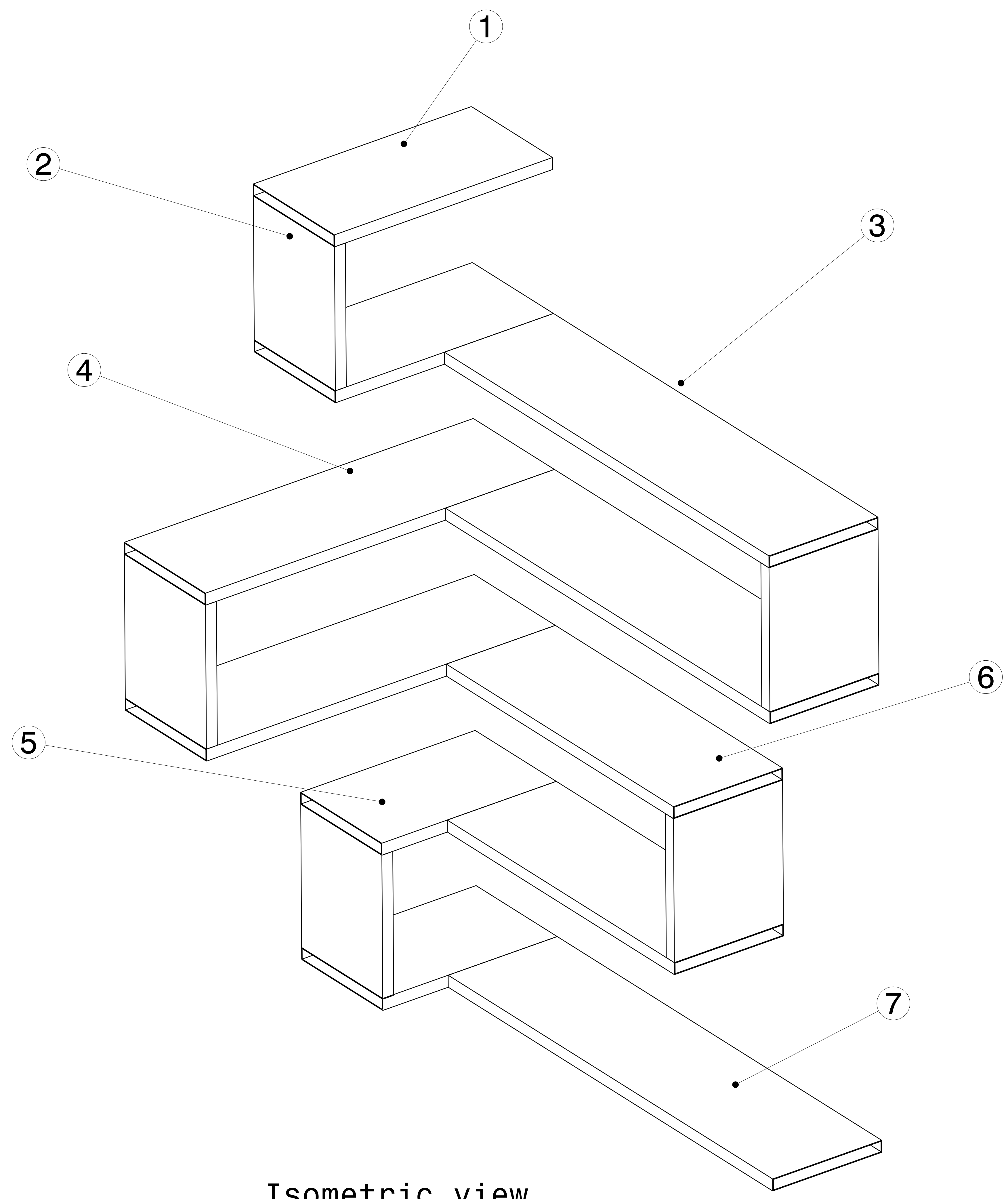

Isometric view

ITEM NO.	PART NUMBER	DESCRIPTION	QTY.	Wt(Kg)/Each
7	PLANK 7	250 X 25 X 1.6 X 1000	1	6.80
6	PLANK 6	250 X 25 X 1.6 X 700	2	0.80
5	PLANK 5	250 X 25 X 1.6 X 400	2	2.70
4	PLANK 4	250 X 25 X 1.6 X 800	2	5.50
3	PLANK 3	250 X 25 X 1.6 X 1000	2	6.80
2	PLANK 2	250 X 25 X 1.6 X 300	5	2.0
1	PLANK 1	250 X 25 X 1.6 X 500	2	3.41

This drawing is our property. It can't be reproduced or communicated without our written agreement.		APL APOLLO TUBES LTD. 	
DRAWN BY RR		DATE 26MAR2021	
CHECKED BY P2P Analysis & Solutions		DATE 26MAR2021	
DESIGNED BY P2P Analysis & Solutions		DATE 26MAR2021	
DRAWING TITLE WINDOW STAND		SIZE A0	DRAWING NUMBER P2P MAR 21-04
SCALE As Indicated		WEIGHT(kg) 0kg	REV 00

UNLESS OTHERWISE SPECIFIED DIMENSION ARE IN MM  
VIEWS: THIRD ANGLE PROJECTION

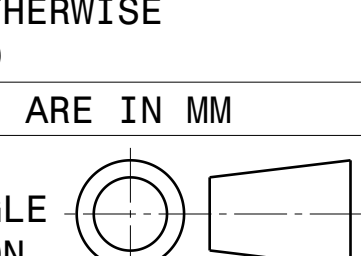

REV	DATE	DESCRIPTION
00	26MAR2021	INITIAL REVISION

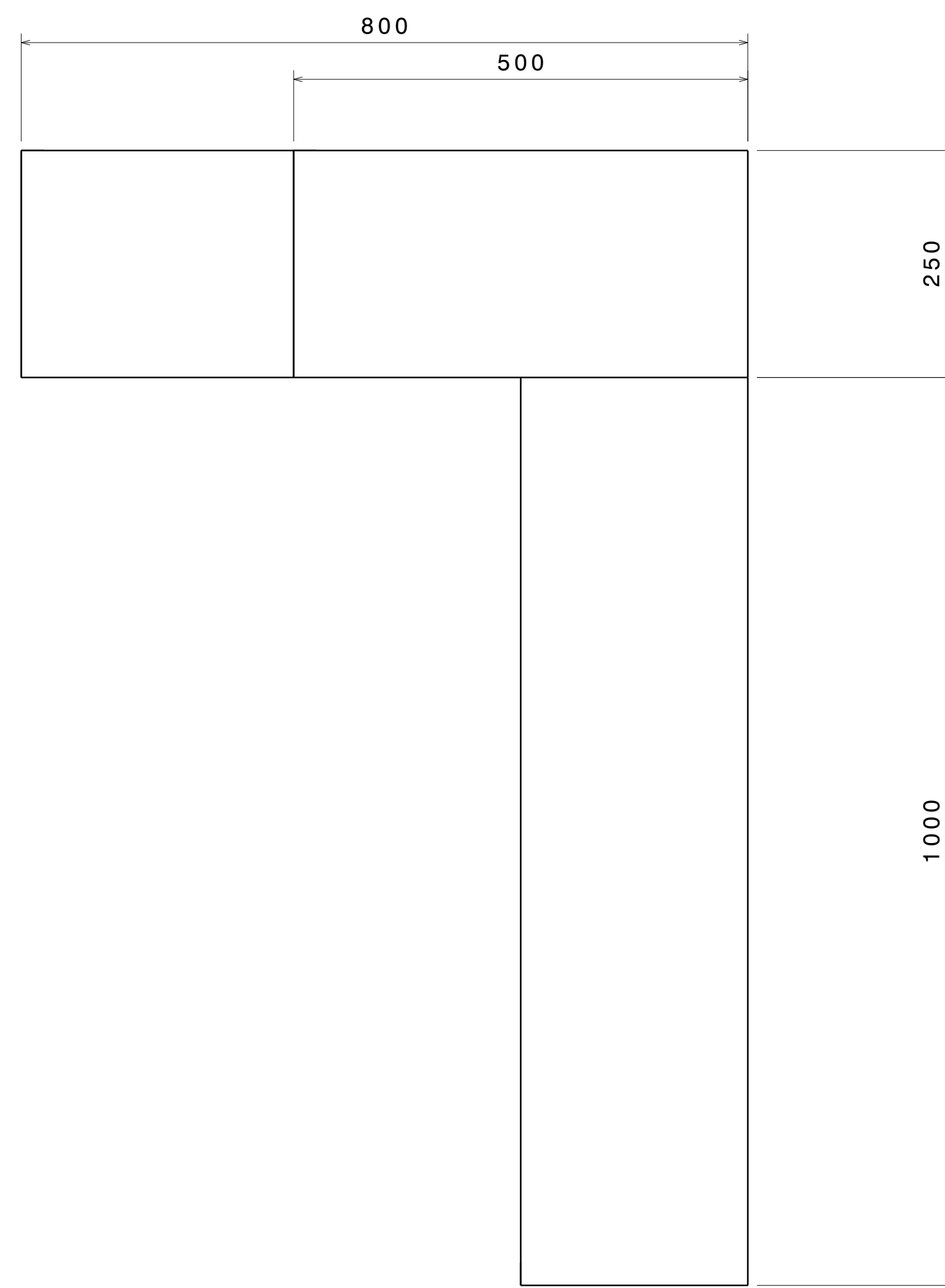

Top view  
Scale: 1:5

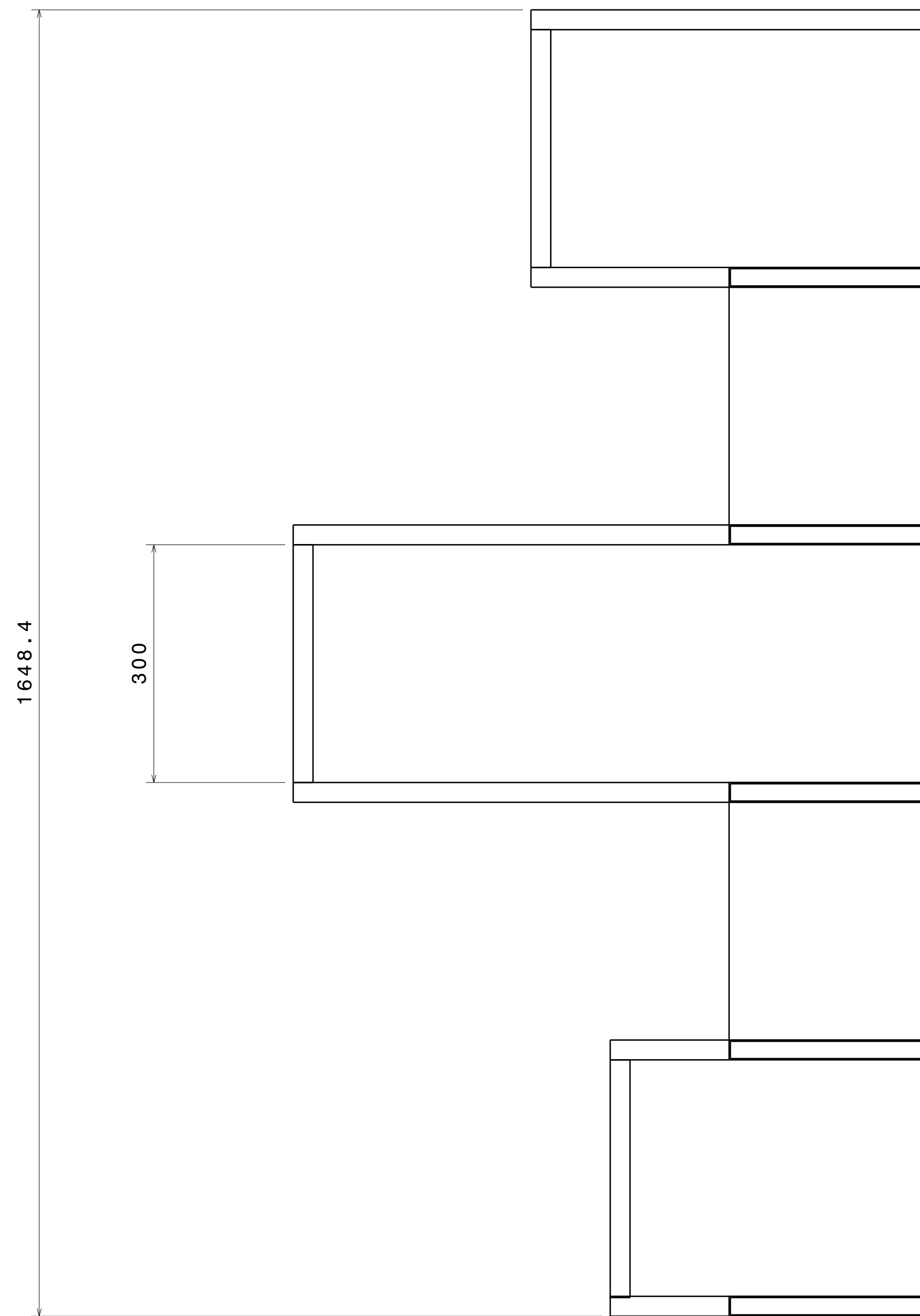

Front view  
Scale: 1:5

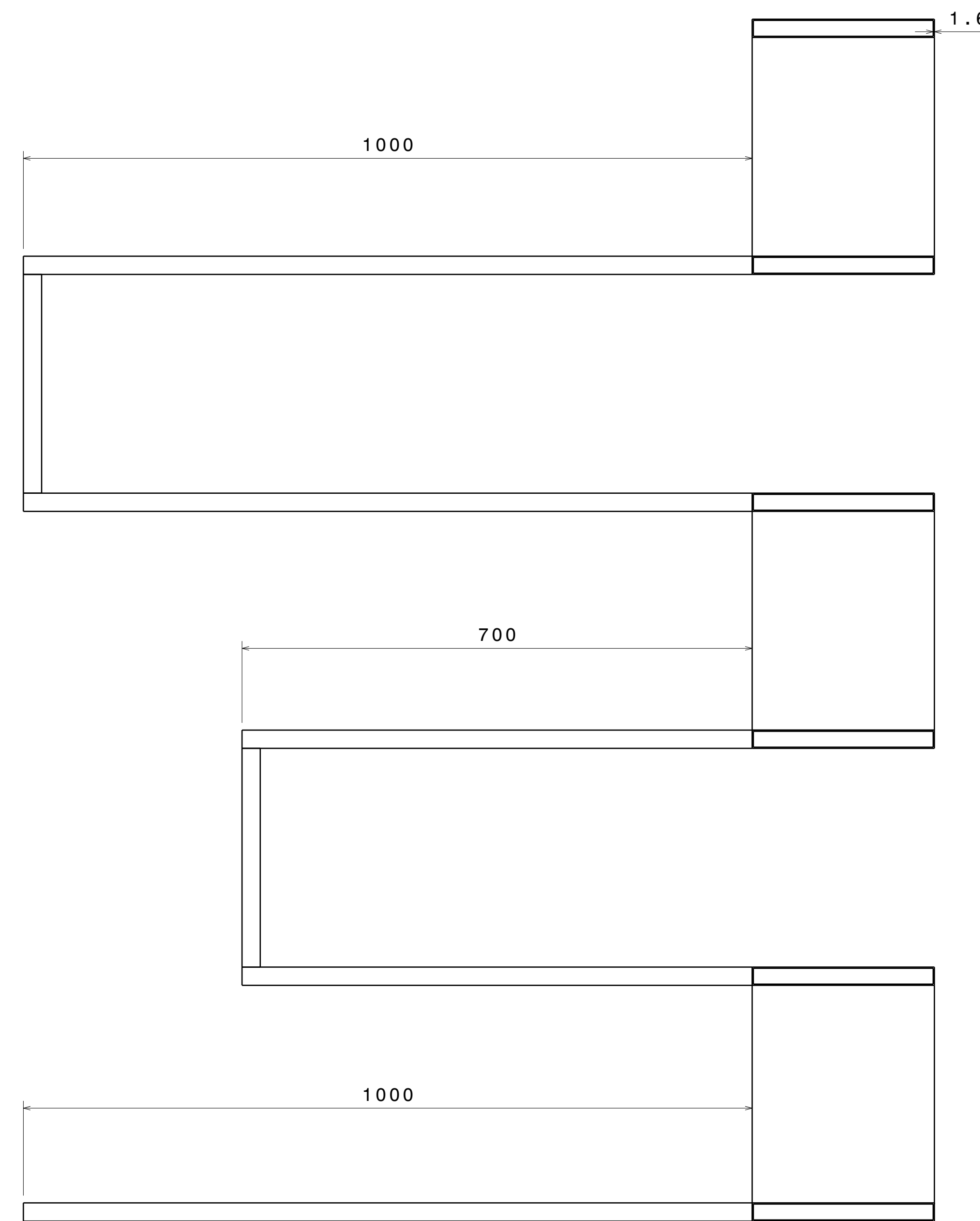

Right view  
Scale: 1:5

UNLESS OTHERWISE SPECIFIED DIMENSION ARE IN MM  
VIEWS: THIRD ANGLE PROJECTION

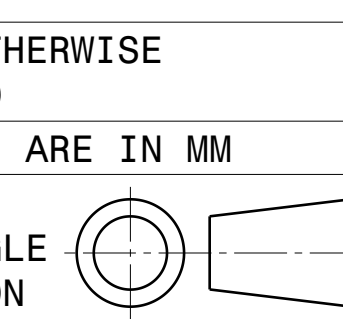

This drawing is our property. It can't be reproduced or communicated without our written agreement.

DRAWN BY	DATE
SB	26MAR2021
CHECKED BY	DATE
P2P Analysis & Solutions	26MAR2021
DESIGNED BY	DATE
P2P Analysis & Solutions	26MAR2021

APL APOLLO TUBES LTD. 	
DRAWING TITLE	
WINDOW STAND	
SIZE	DRAWING NUMBER
A0	P2P MAR 21-04
SCALE	WEIGHT (kg)
NONE	XXX
REV	SHEET 2 OF 3
00	

REV	DATE	DESCRIPTION
00	26MAR2021	INITIAL REVISION

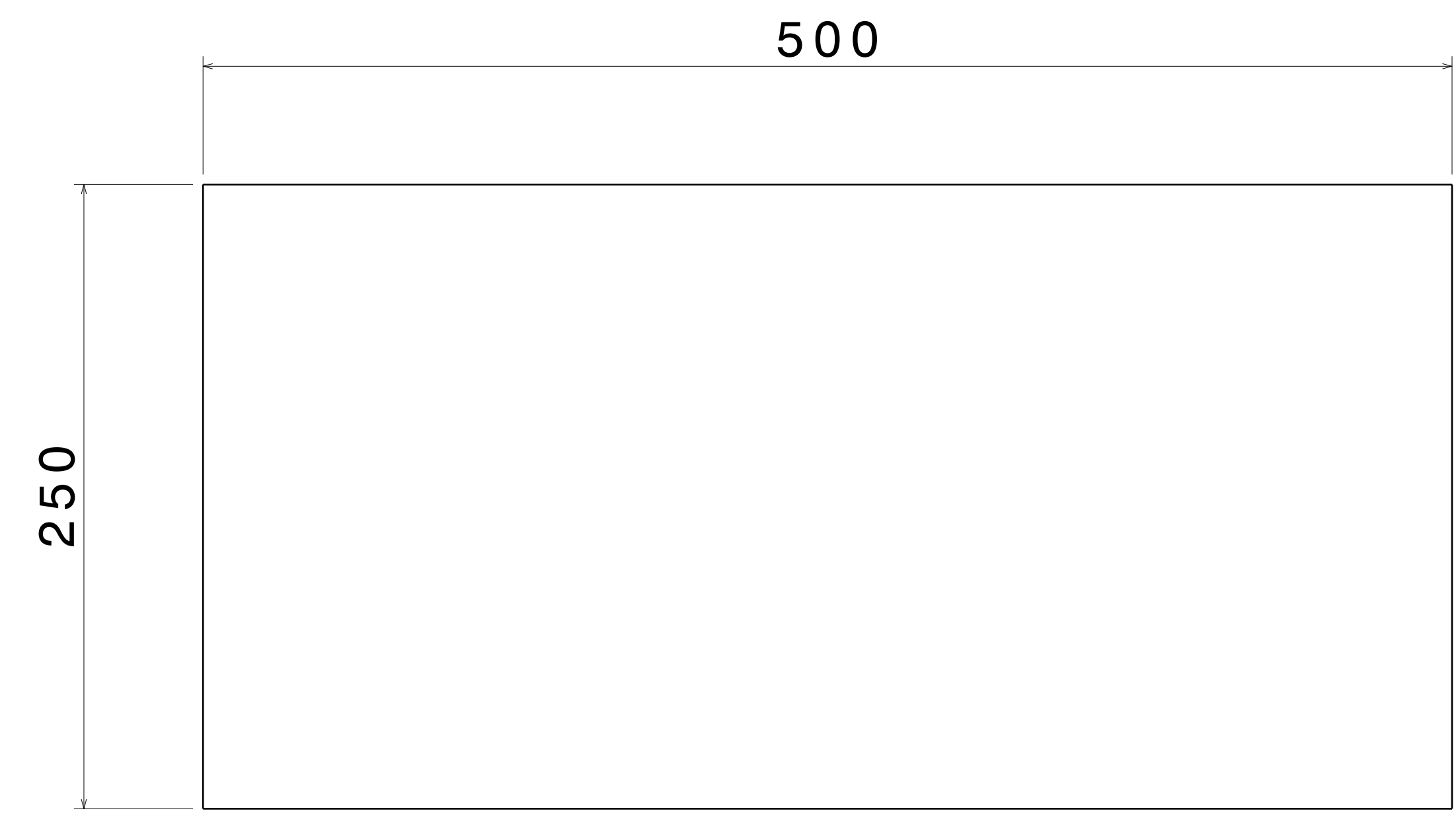

ITEM 1

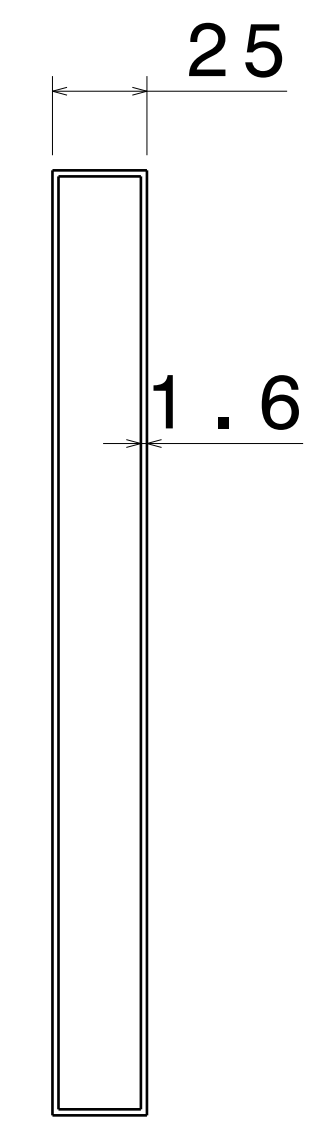

Right view  
Scale: 1:2

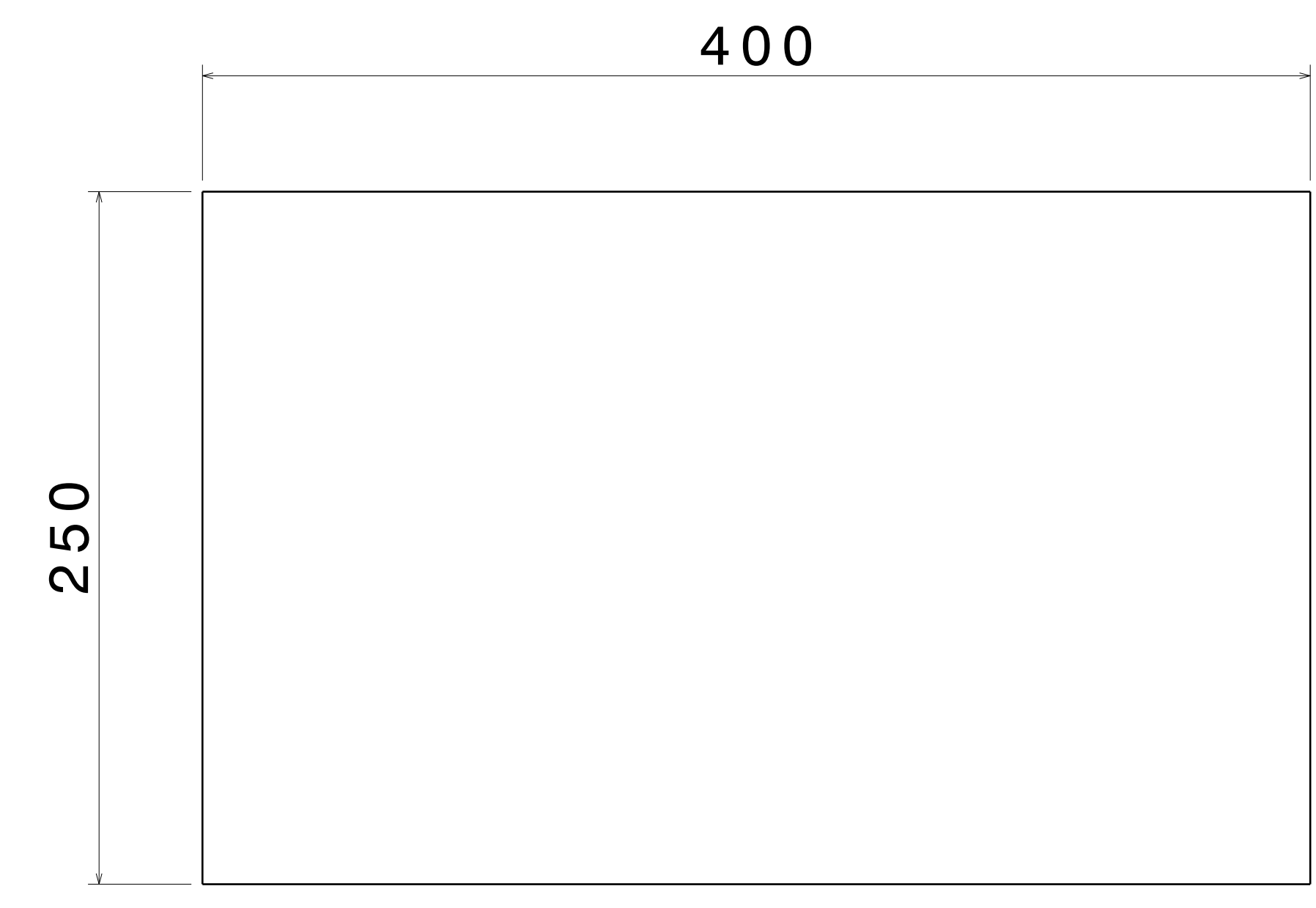

ITEM 5

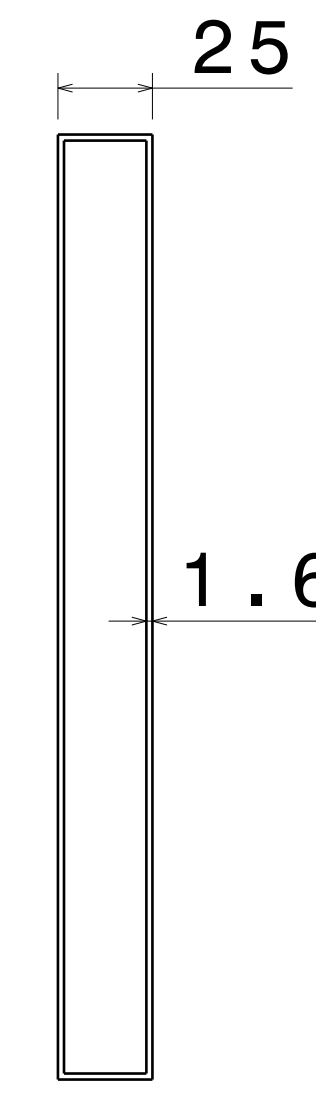

Right view  
Scale: 1:2

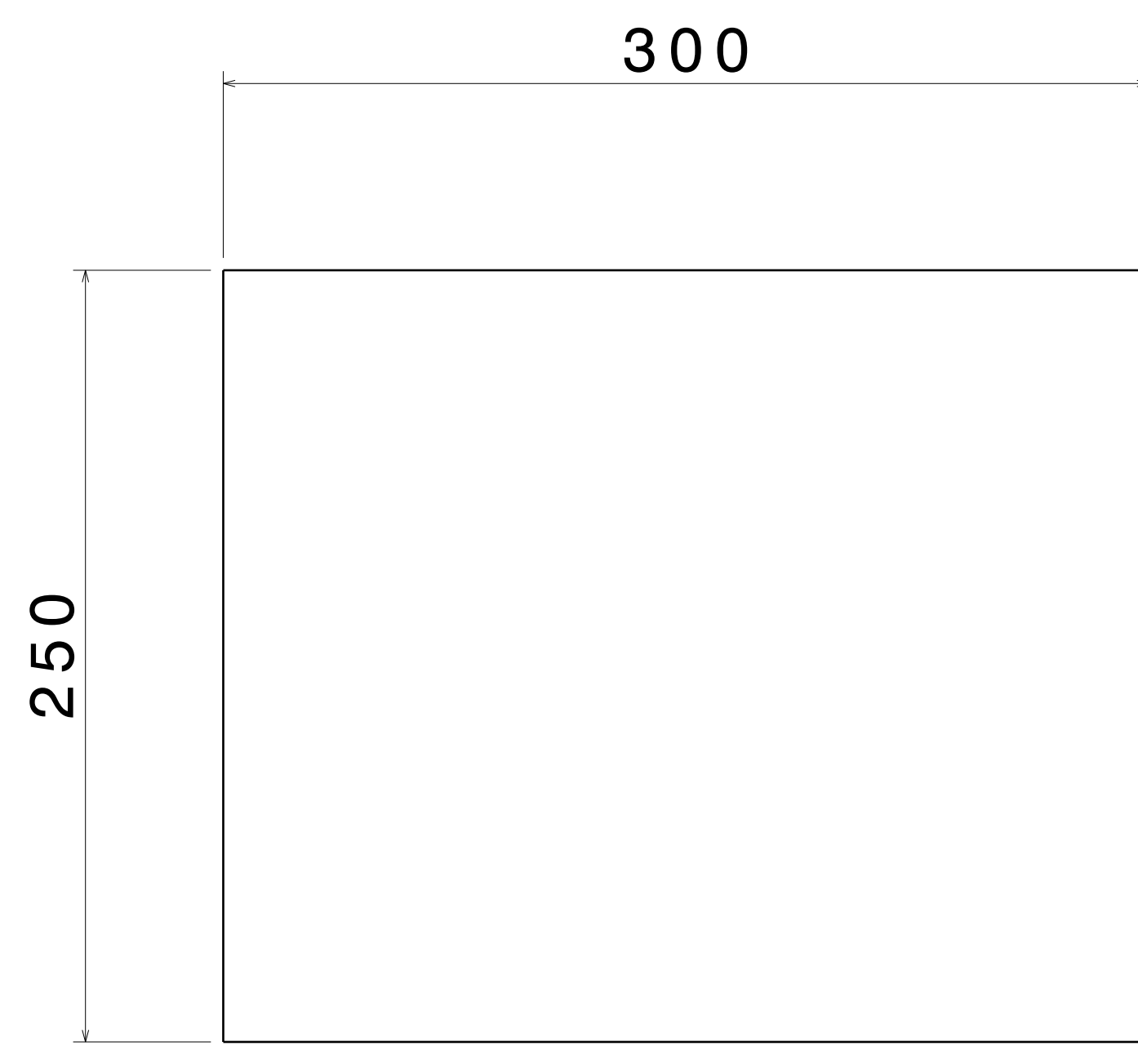

ITEM 2

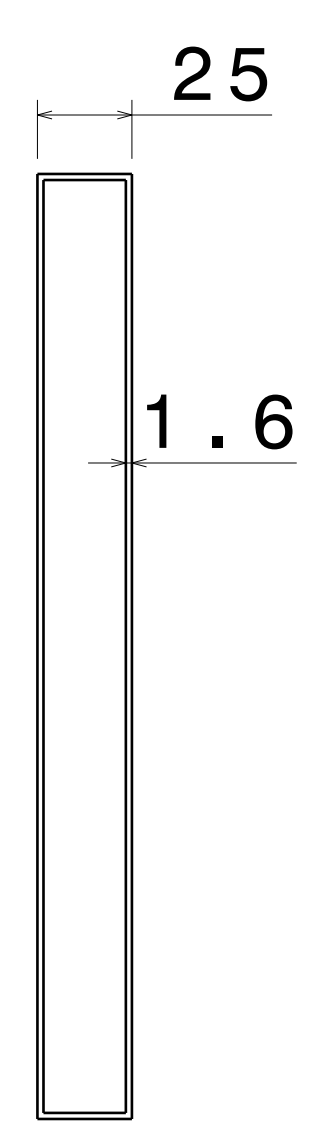

Right view  
Scale: 1:2

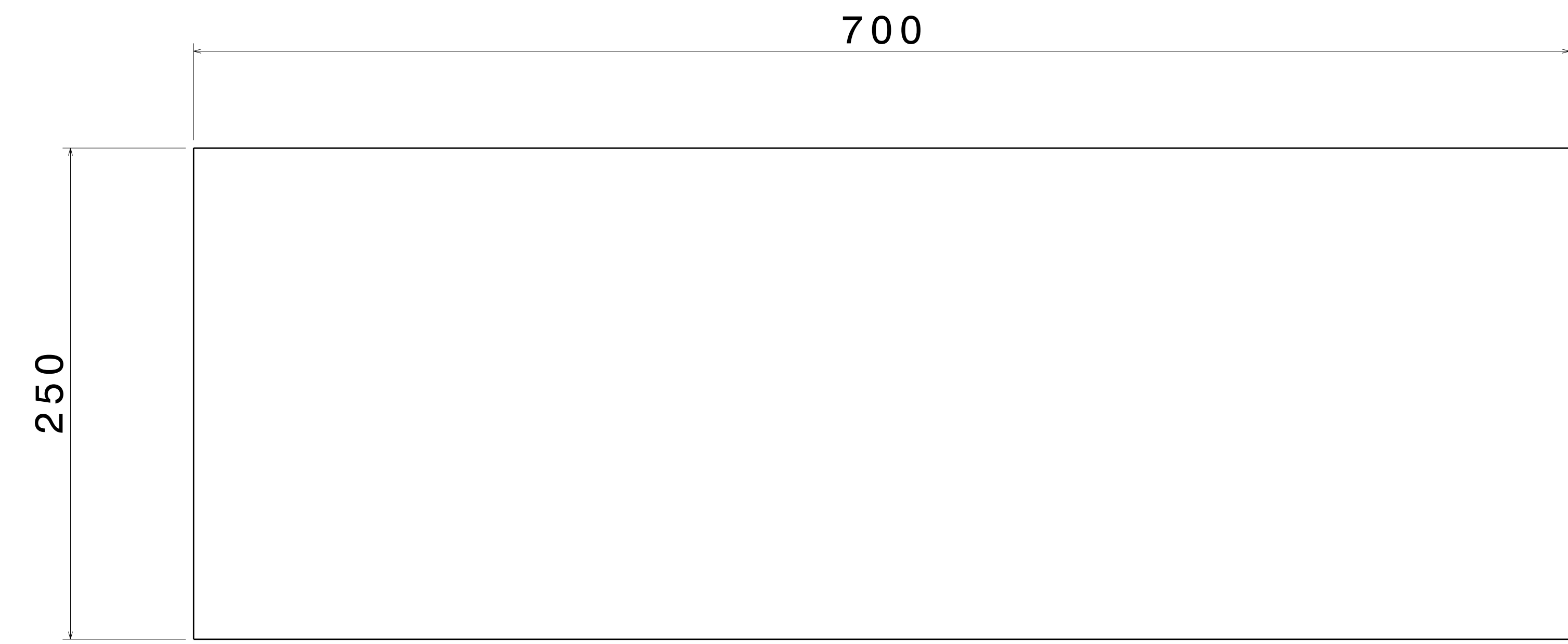

ITEM 6

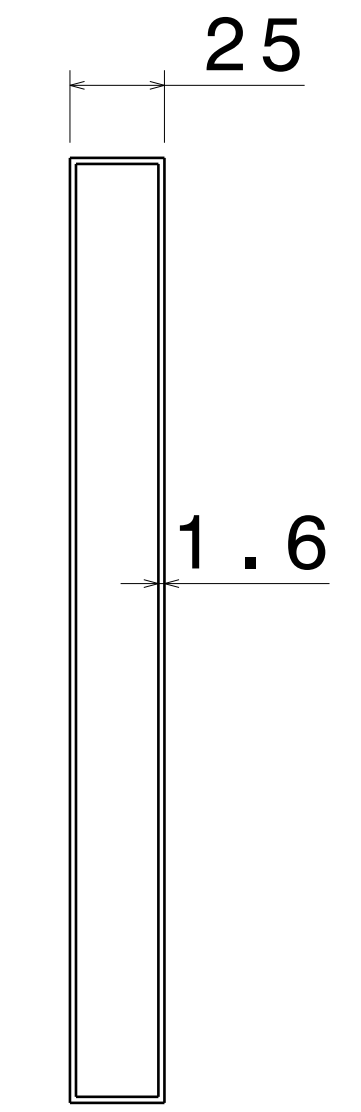

Right view  
Scale: 1:2

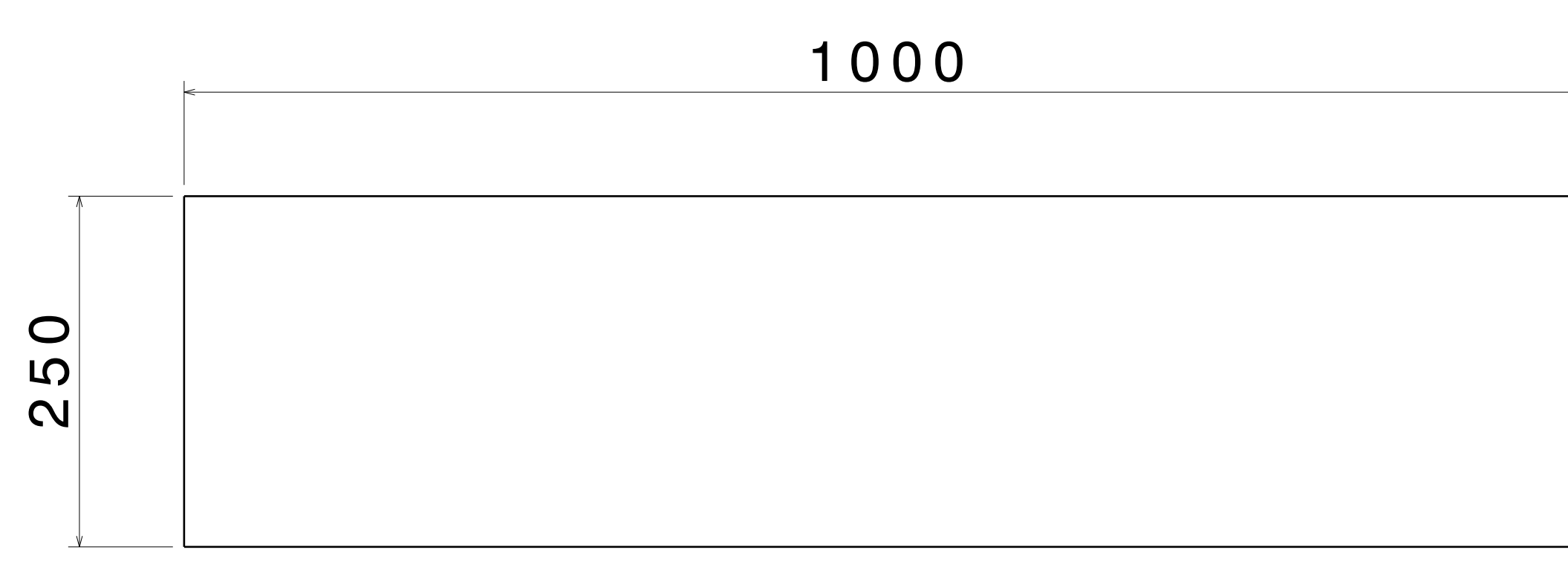

ITEM 3

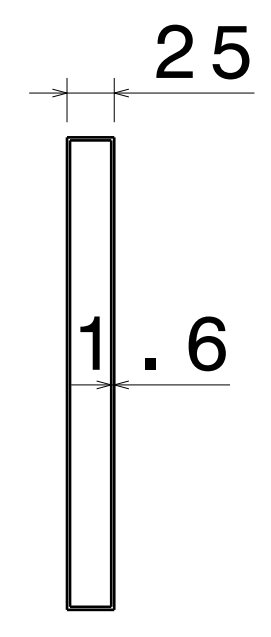

Right view  
Scale: 1:4

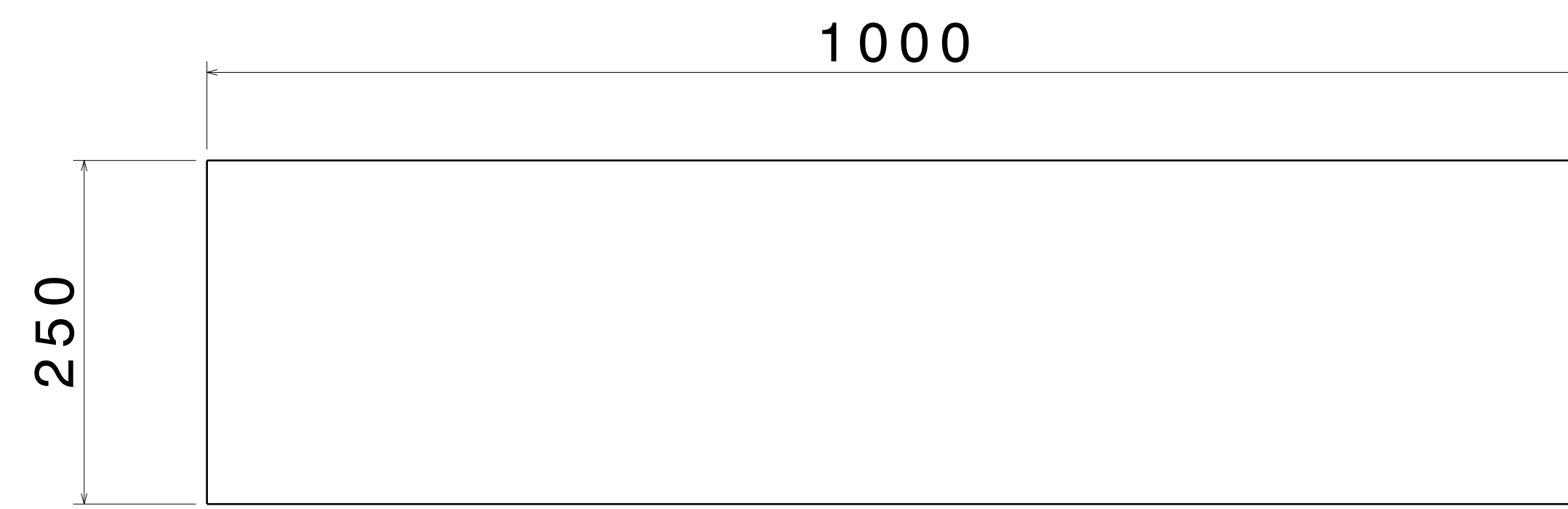

ITEM 7

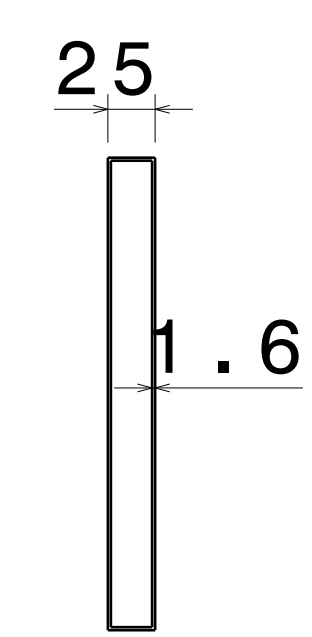

Right view  
Scale: 1:4

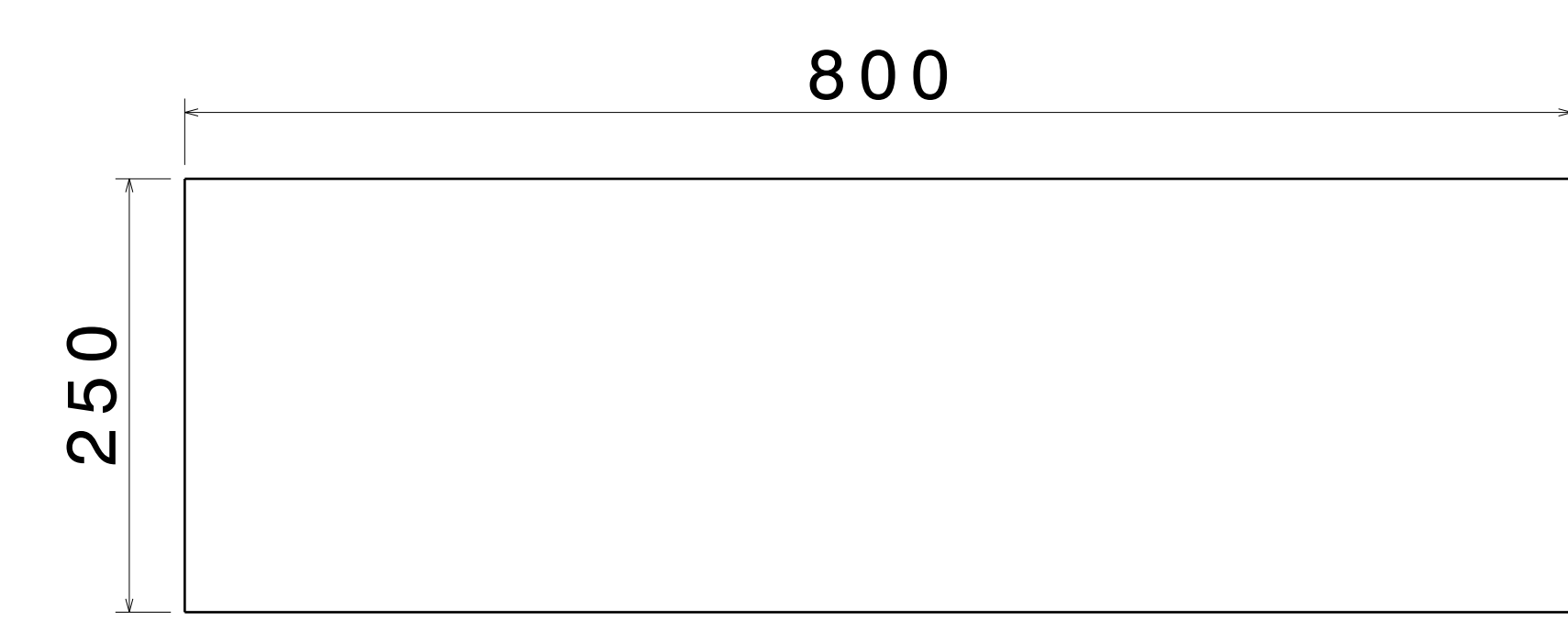

ITEM 4

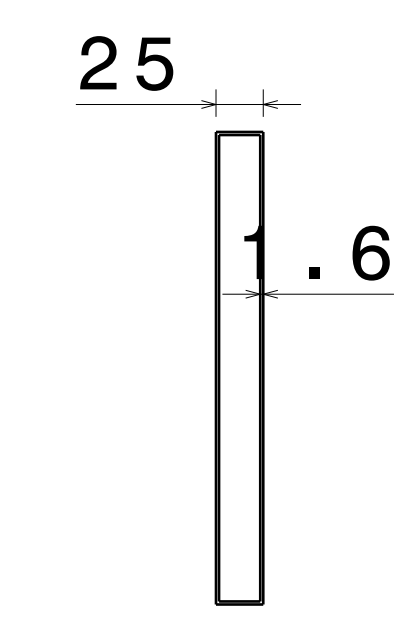

Right view  
Scale: 1:4

This drawing is our property.  
It can't be reproduced  
or communicated without  
our written agreement.

APL APOLLO TUBES LTD. 

DRAWN BY	DATE
SB	26MAR2021
CHECKED BY	DATE
P2P Analysis & Solutions	26MAR2021
DESIGNED BY	DATE
P2P Analysis & Solutions	26MAR2021

DRAWING TITLE	
WINDOW STAND	
SIZE	DRAWING NUMBER
A0	P2P MAR 21-04
SCALE	WEIGHT (kg)
NONE	XXX
SHEET 3 OF 3	

UNLESS OTHERWISE SPECIFIED  
DIMENSION ARE IN MM  
VIEWS:  
THIRD ANGLE PROJECTION

