

REV	DATE	DESCRIPTION
00	26MAR2021	INITIAL REVISION

- NOTES:
- (⊥) ALL VERTICAL SUPPORTS ARE PERPENDICULAR.
 - FLATNESS OF .5MM IS APPLIED BY DEFAULT.
 - ⊥ WELD BEAD OF 2MM RADIUS IS FOLLOWED.
 - ▽ SURFACE FINISH MEDIUM TO SMOOTH IS USED.
 - ALL TUBES ARE AS PER APL APOLLO STANDARD. CHANGES MAY EFFECT THE LOAD CAPACITY.
 - ALL HORIZONTAL AND VERTICAL TUBES ARE PERPENDICULAR TO EACH OTHER WITH ±1 DEG.
 - FINE WELDING IS REQUIRED AS PER MENTIONED DETAILS AND FINISHING.
 - HIGHER CURRENT WELDING MAY AFFECT THE BRITTLNESS OF MATERIAL WHICH LATER MAY RAISE TO WEAKENING OF STRUCTURE.
 - FABRICATORS ARE ALLOWED TO USE FITTINGS/FRAMES/SUPPORTS AS NEEDED AND THE SAME MUST BE COMMUNICATED BACK TO ENGINEERING TEAM.
 - BOP COMPONENT WEIGHTS ARE FOR REFERENCE ONLY AND SUBJECTED TO CHANGE PER PURCHASED COMPONENTS.

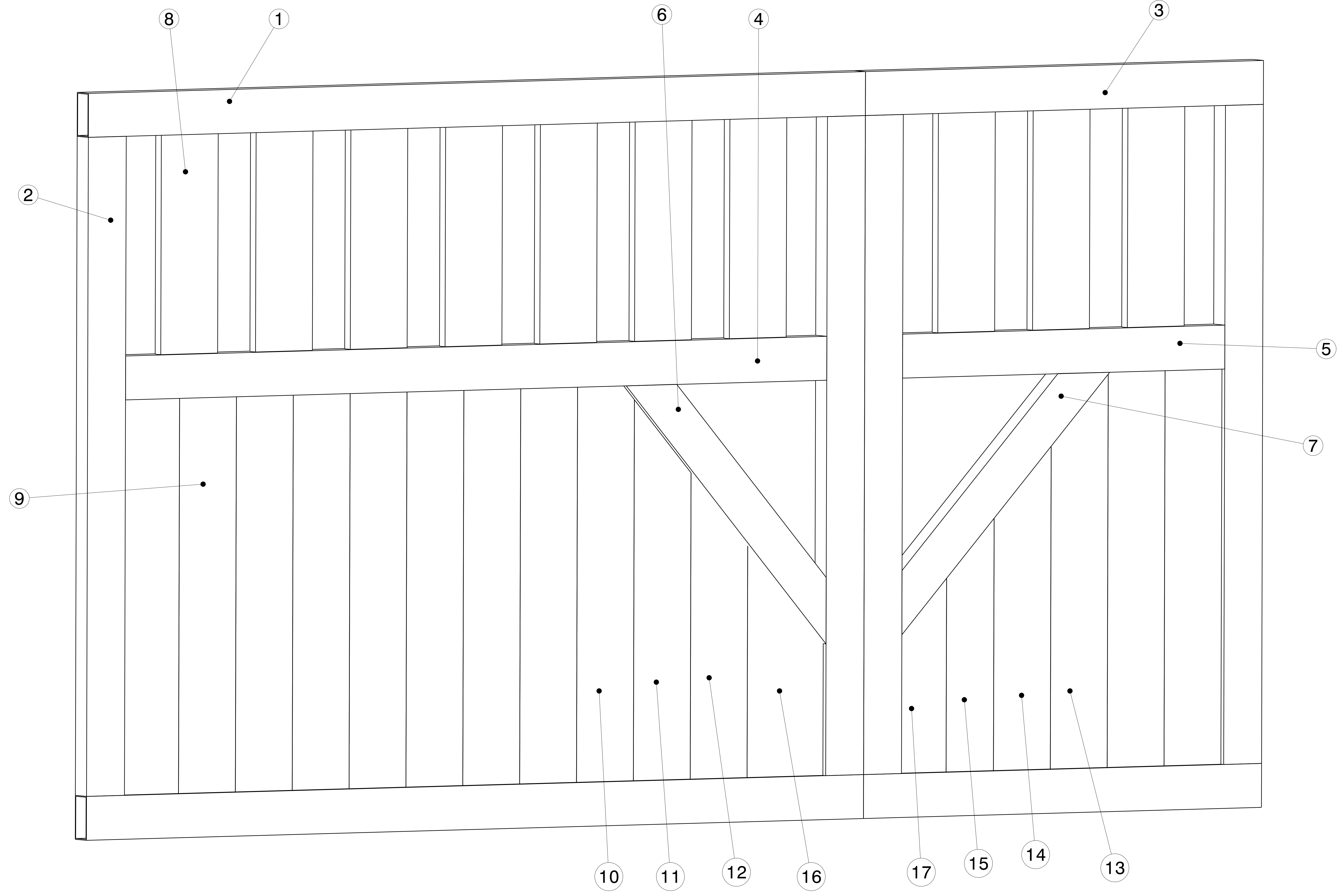

Isometric view

ITEM NO.	PART NUMBER	DESCRIPTION	QTY.	Wt (Kg)/Each
17	PLANK 10	125 X 25 X 1.6 X 500	1	1.15
16	PLANK 9	200 X 25 X 1.6 X 550	1	2.30
15	PLANK 8	125 X 25 X 1.6 X 700	1	2.20
14	PLANK 7	150 X 25 X 1.6 X 800	1	2.85
13	PLANK 6	150 X 25 X 1.6 X 900	1	3.90
12	PLANK 5	150 X 254 X 1.6 X 750	1	2.65
11	PLANK 4	150 X 25 X 1.6 X 900	1	3.90
10	PLANK 3	150 X 25 X 1.6 X 900	1	3.90
9	PLANK 2	150 X 25 X 1.6 X 900	10	3.90
8	PLANK 1	150 X 25 X 1.6 X 500	10	2.15
7	RHS FRAME 7	100 X 50 X 2 X 800	1	3.90
6	RHS FRAME 6	100 X 50 X 2 X 800	1	3.20
5	RHS FRAME 5	100 X 50 X 2 X 850	1	3.90
4	RHS FRAME 4	100 X 50 X 2 X 1850	1	8.50
3	RHS FRAME 3	100 X 50 X 2 X 1050	2	4.80
2	RHS FRAME 2	100 X 50 X 2 X 1500	4	6.90
1	RHS FRAME 1	100 X 50 X 2 X 2050	2	9.40

This drawing is our property. It can't be reproduced or communicated without our written agreement.

APL APOLLO TUBES LTD.

DRAWING TITLE: **GATE**

DRAWN BY: RR	DATE: 26MAR2021	CHECKED BY: P2P Analysis & Solutions	DATE: 26MAR2021	DESIGNED BY: P2P Analysis & Solutions	DATE: 26MAR2021
--------------	-----------------	--------------------------------------	-----------------	---------------------------------------	-----------------

SIZE: A0	DRAWING NUMBER: P2P MAR 21-10	REV: 00
SCALE: As Indicated	WEIGHT (kg): 0kg	SHEET 1 OF 3

UNLESS OTHERWISE SPECIFIED DIMENSION ARE IN MM
 VIEWS: THIRD ANGLE PROJECTION

REV	DATE	DESCRIPTION
00	26MAR2021	INITIAL REVISION

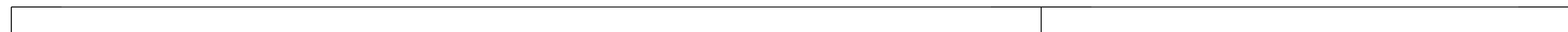

Top view
Scale: 1:5

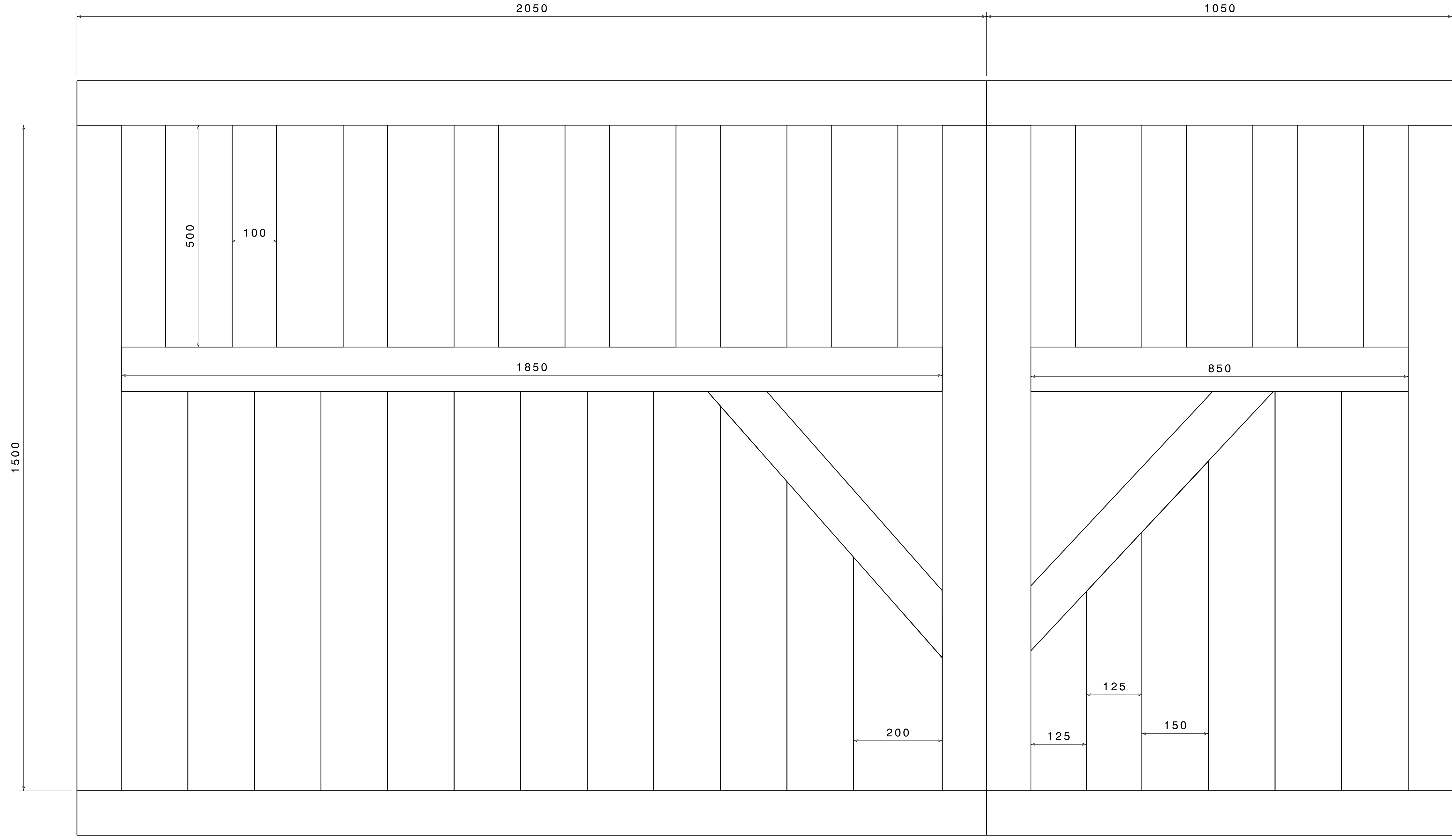

Front view
Scale: 1:5



Right view
Scale: 1:5

UNLESS OTHERWISE SPECIFIED DIMENSION ARE IN MM
VIEWS: THIRD ANGLE PROJECTION

This drawing is our property. It can't be reproduced or communicated without our written agreement.		APL APOLLO TUBES LTD.	
DRAWN BY SB		DATE 26MAR2021	
CHECKED BY P2P Analysis & Solutions		DATE 26MAR2021	
DESIGNED BY P2P Analysis & Solutions		DATE 26MAR2021	
DRAWING TITLE GATE		SIZE A0	DRAWING NUMBER P2P MAR 21-10
SCALE NONE		WEIGHT (kg) XXX	REV 00
			SHEET 2 OF 3

REV	DATE	DESCRIPTION
00	26MAR2021	INITIAL REVISION

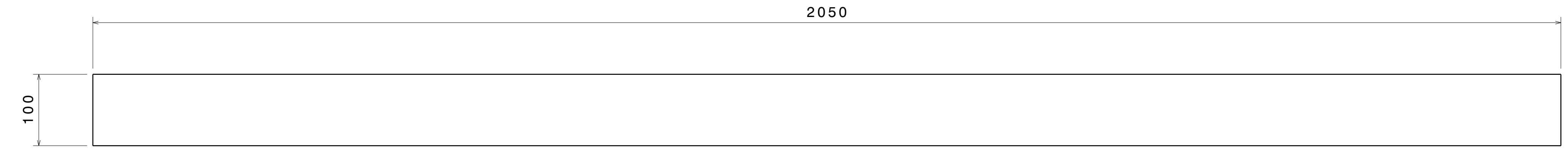

ITEM 1

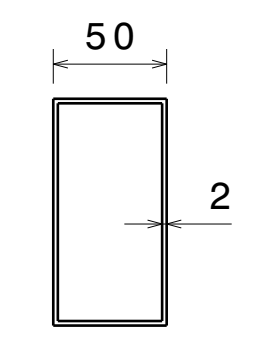

Right view
Scale: 3:10

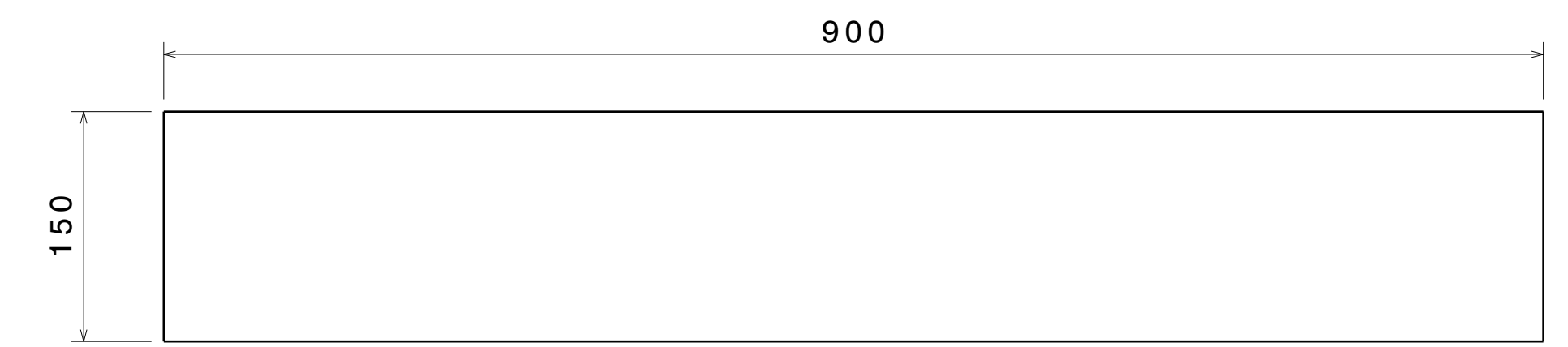

ITEM 9

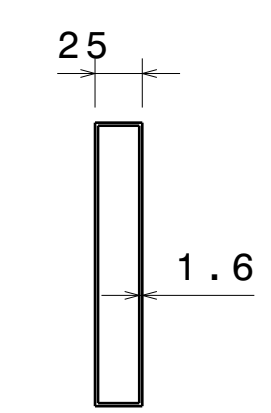

Right view
Scale: 1:4

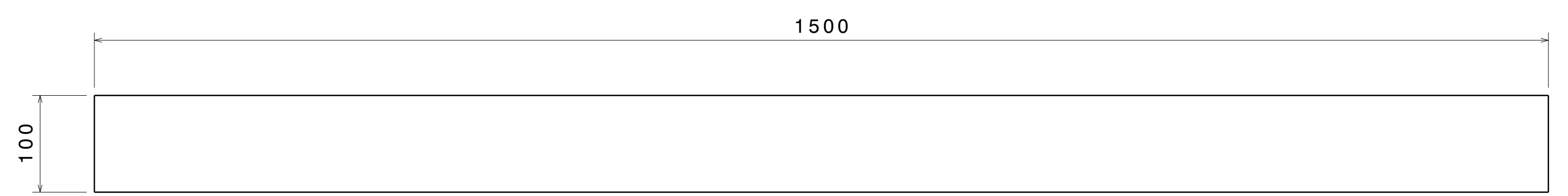

ITEM 2

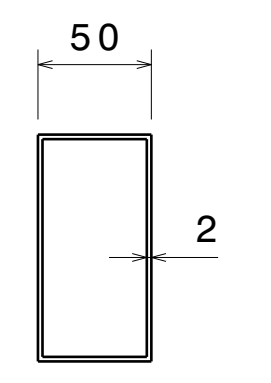

Right view
Scale: 3:10

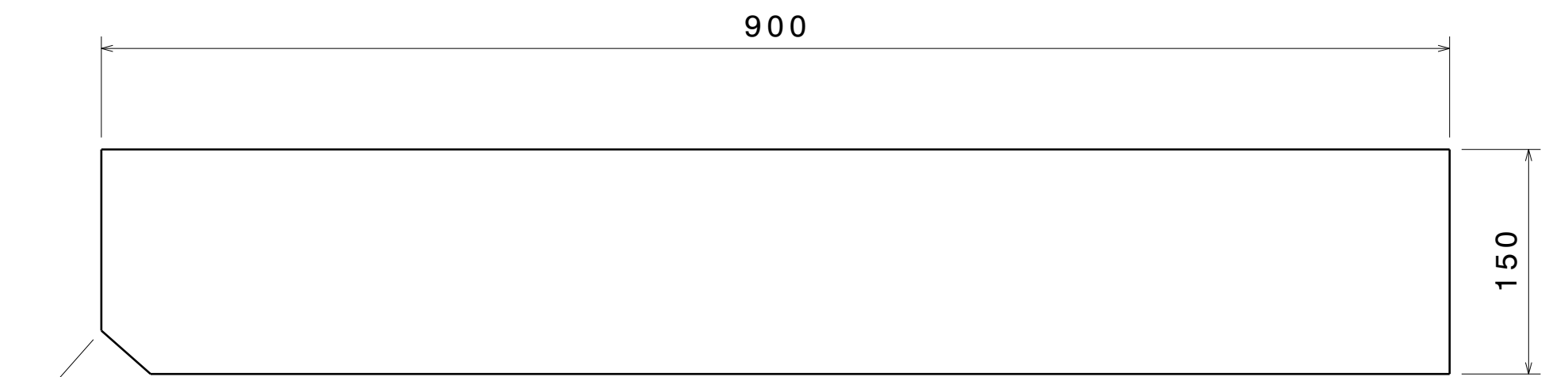

ITEM 10

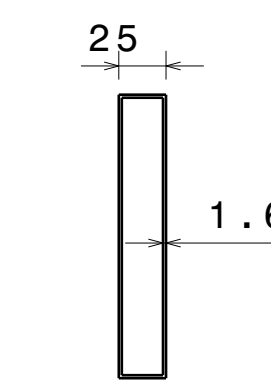

Right view
Scale: 1:4

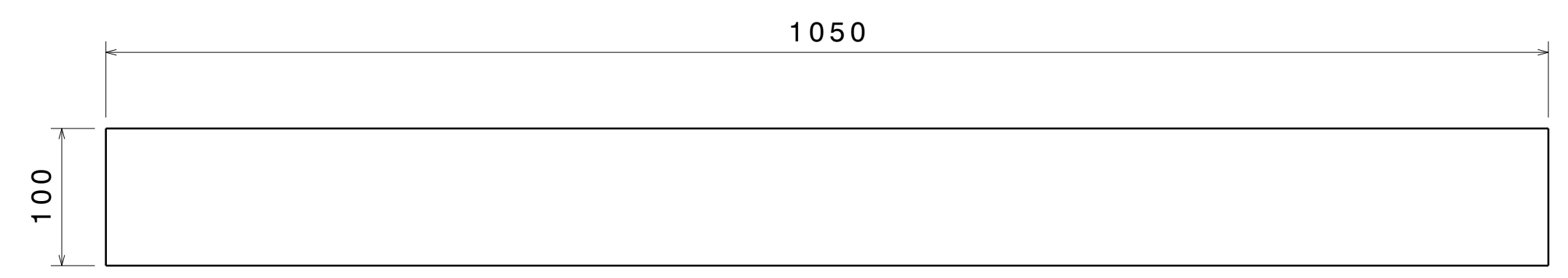

ITEM 3

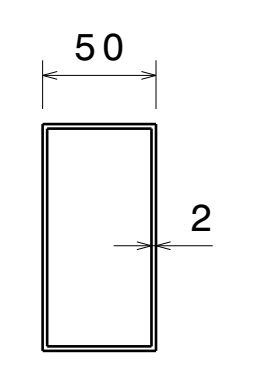

Right view
Scale: 3:10

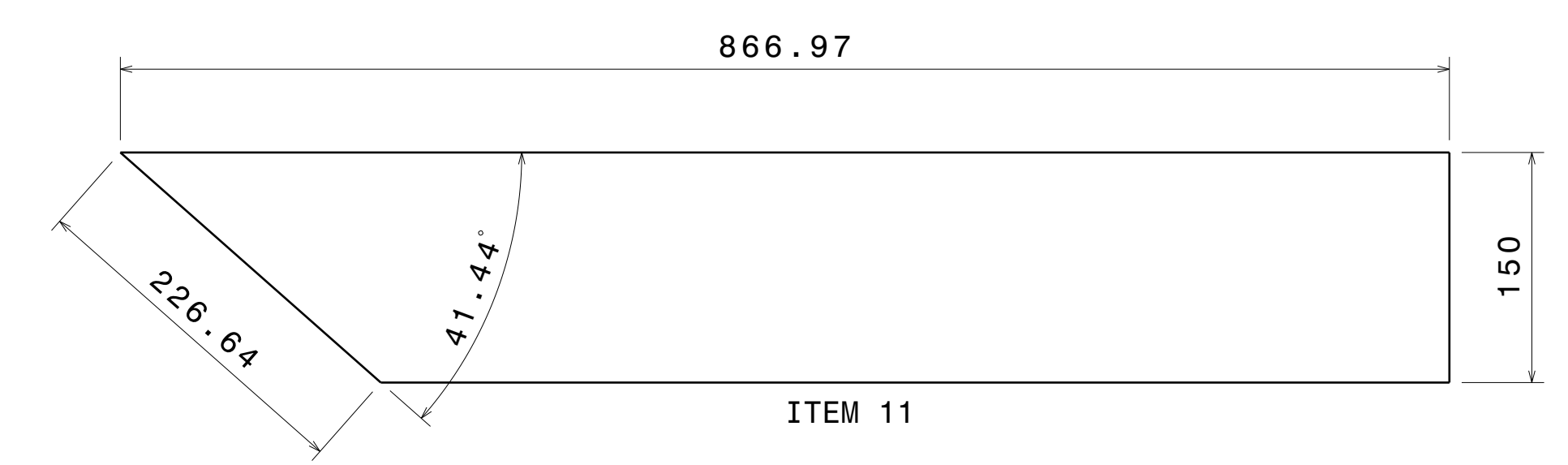

ITEM 11

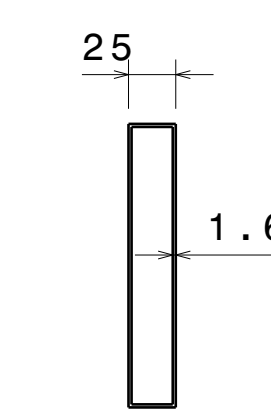

Right view
Scale: 1:4

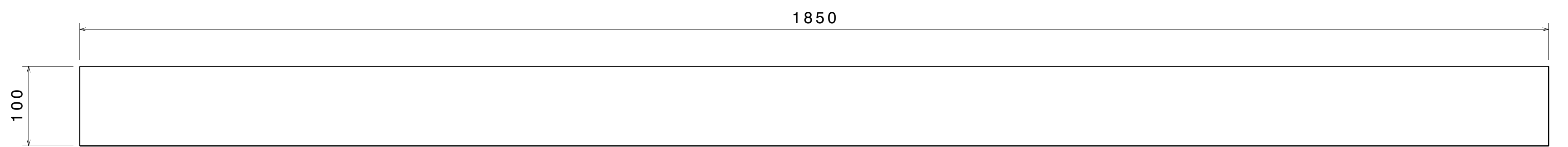

ITEM 4

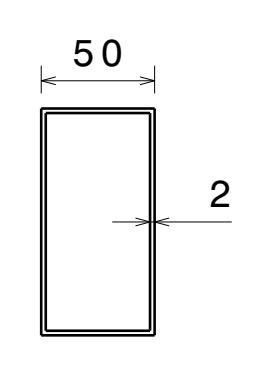

Right view
Scale: 3:10

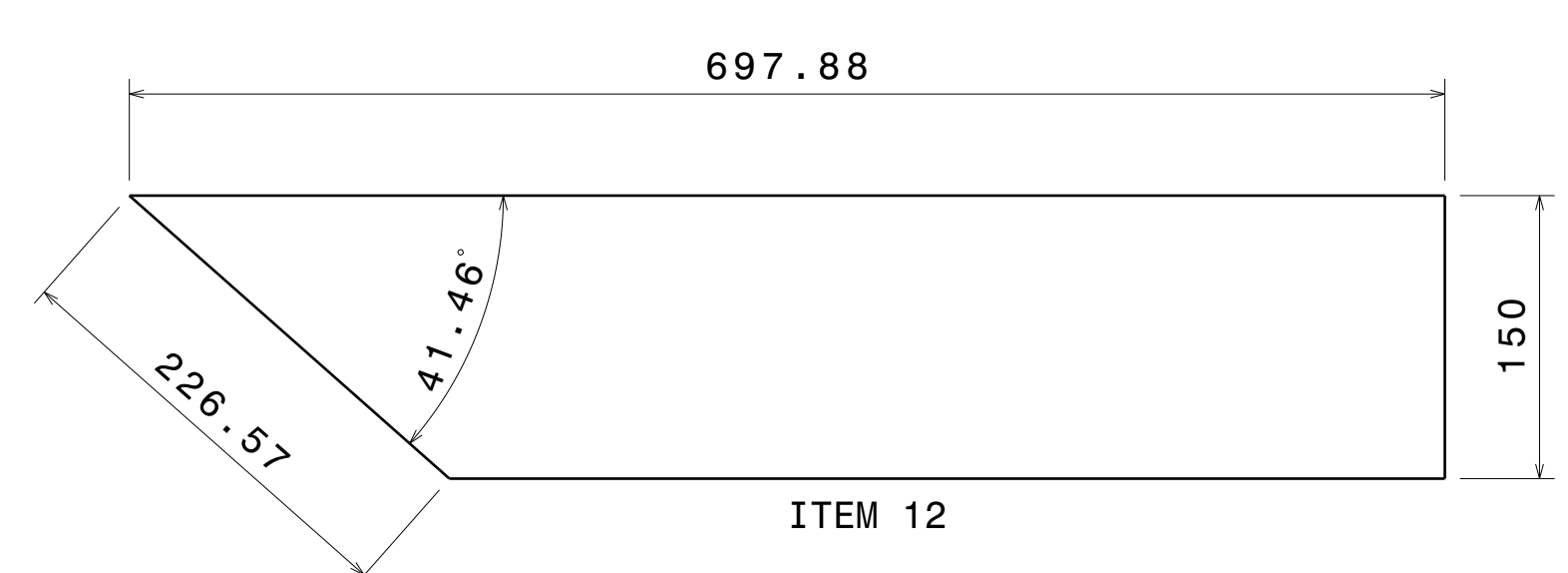

ITEM 12

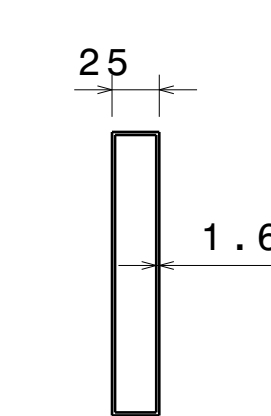

Right view
Scale: 1:4

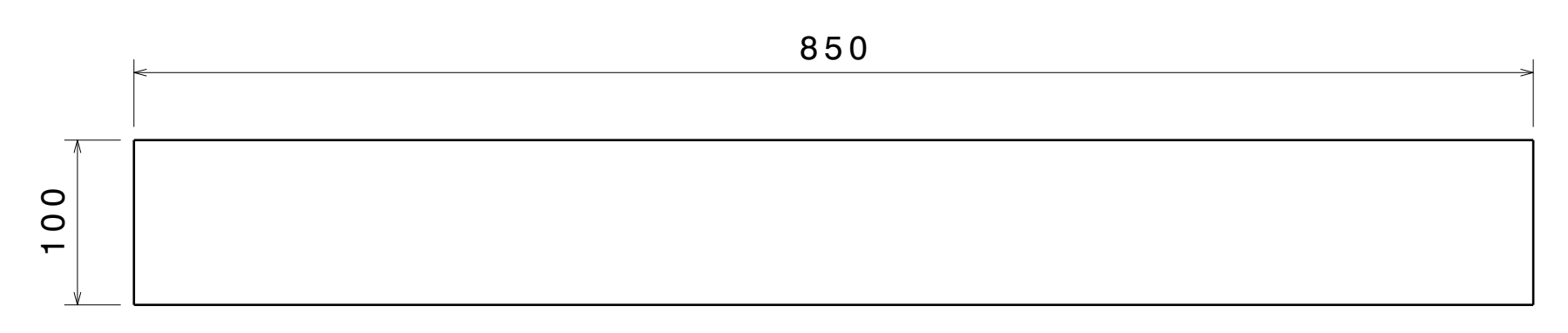

ITEM 5

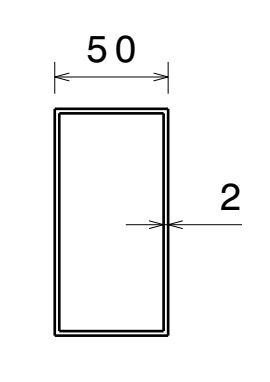

Right view
Scale: 3:10

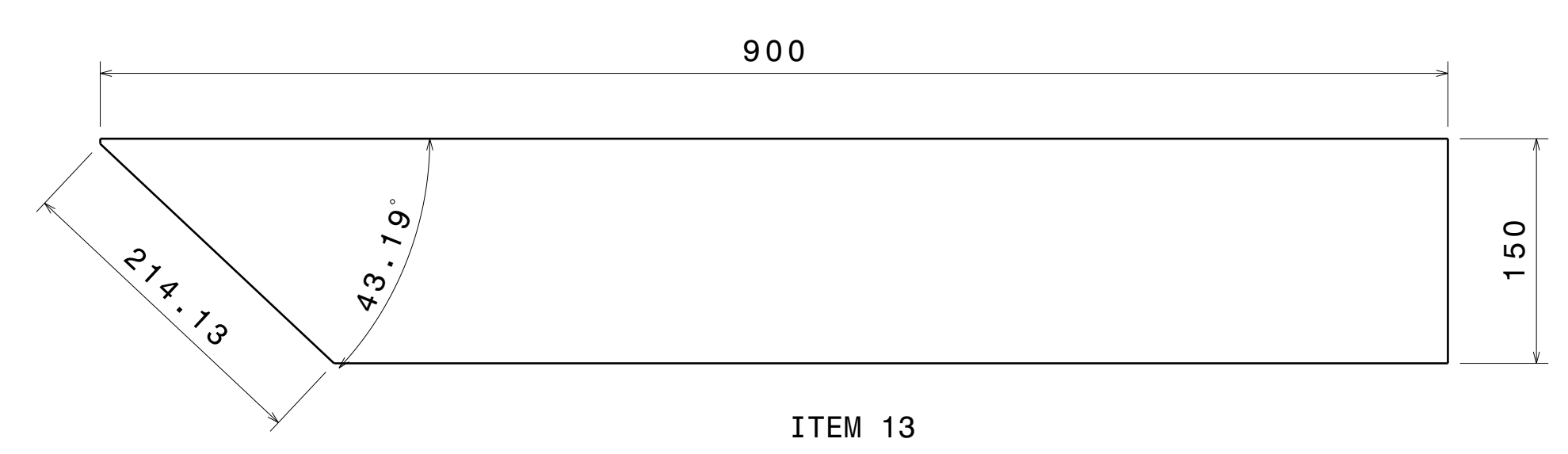

ITEM 13

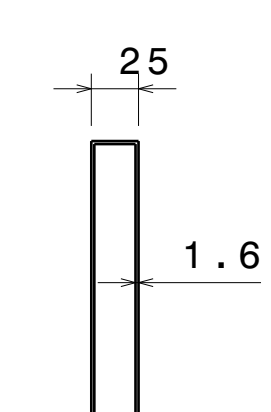

Right view
Scale: 1:4

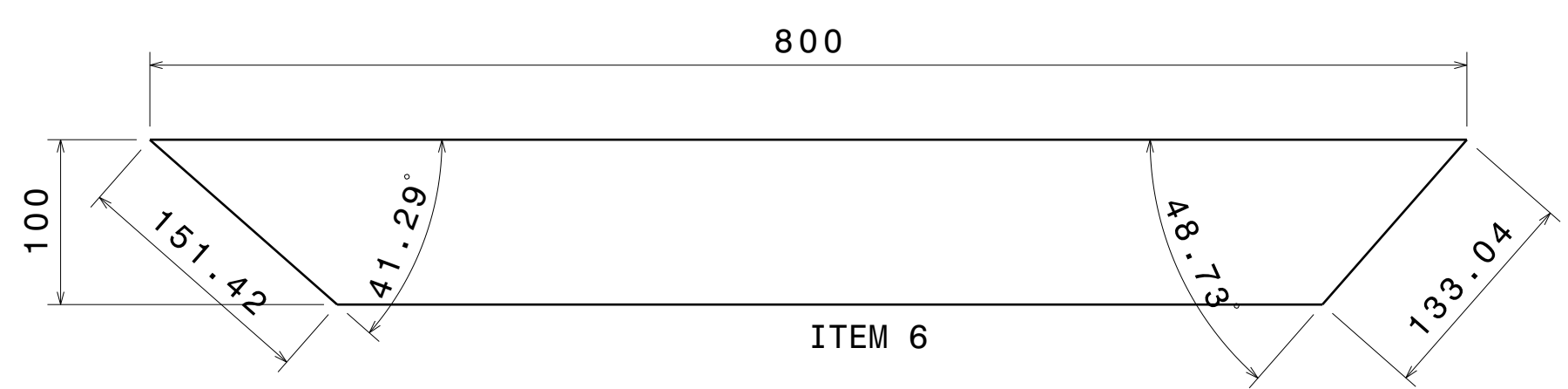

ITEM 6

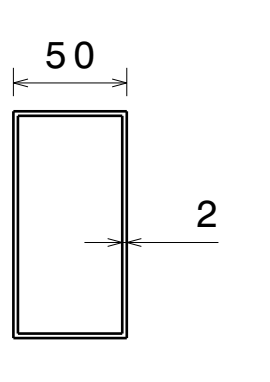

Right view
Scale: 3:10

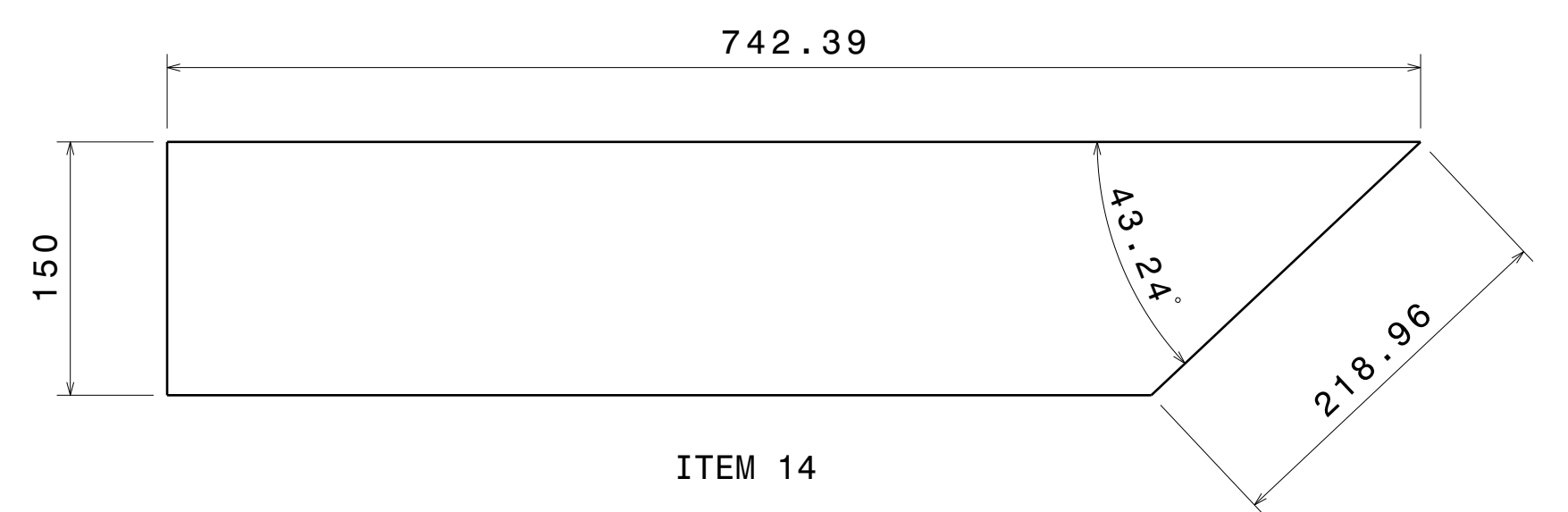

ITEM 14

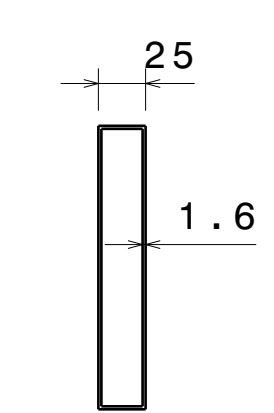

Right view
Scale: 1:4

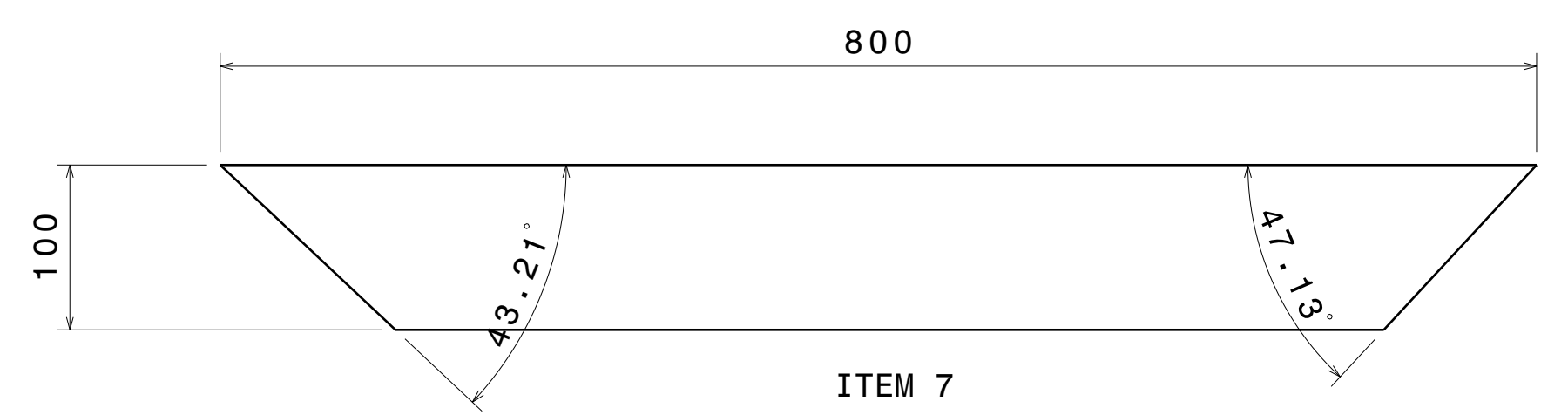

ITEM 7

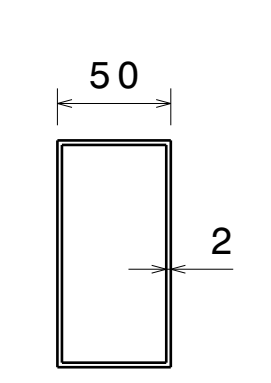

Right view
Scale: 3:10

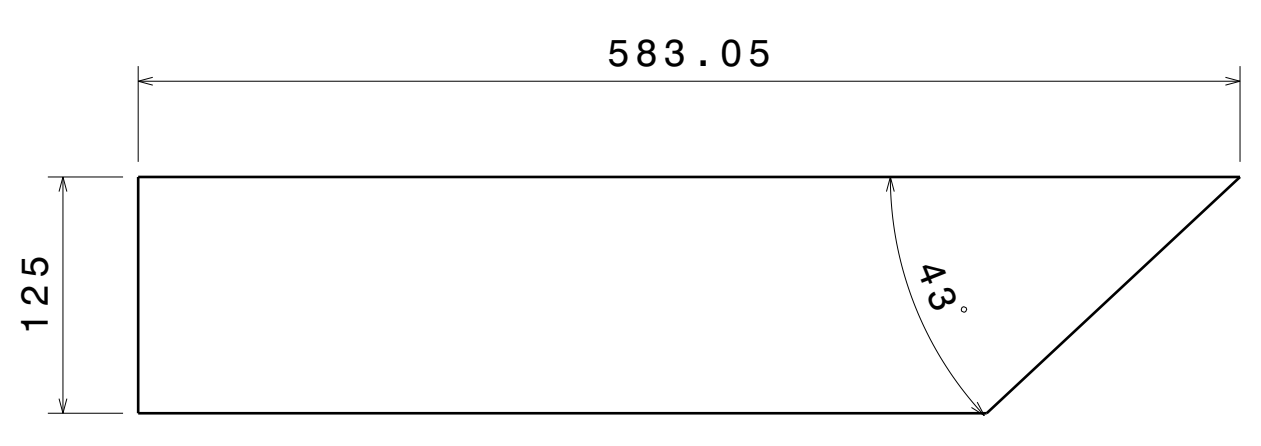

ITEM 15

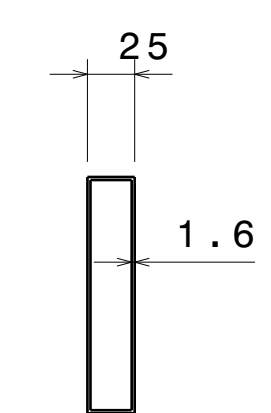

Right view
Scale: 1:4

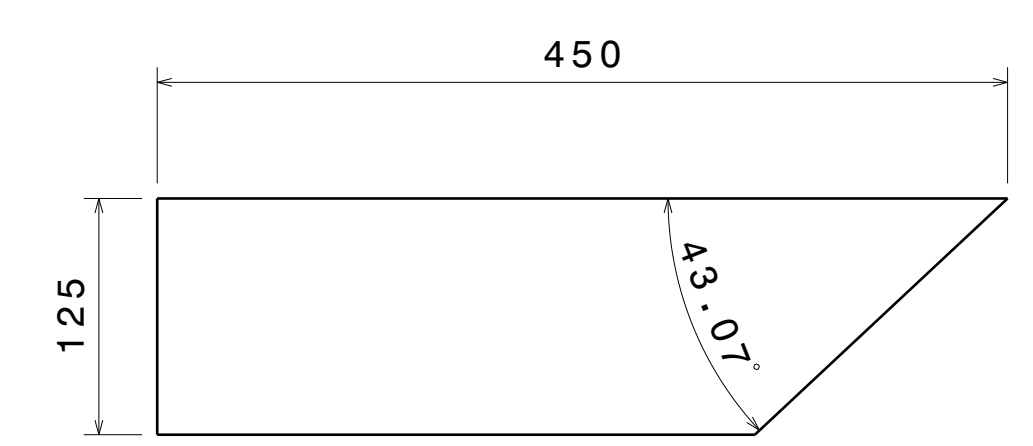

ITEM 17

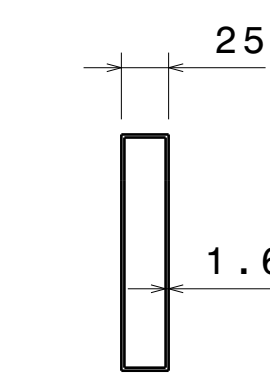

Right view
Scale: 1:4

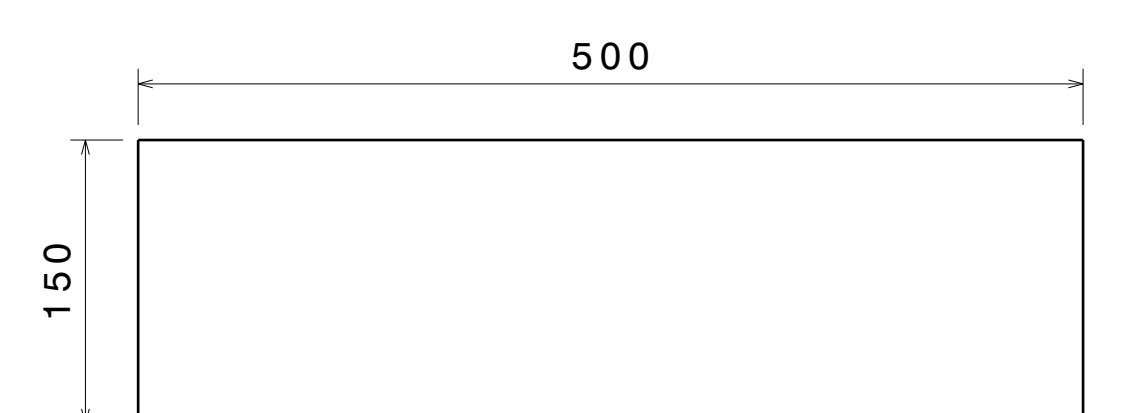

ITEM 8

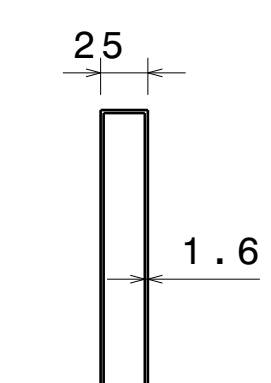

Right view
Scale: 1:4

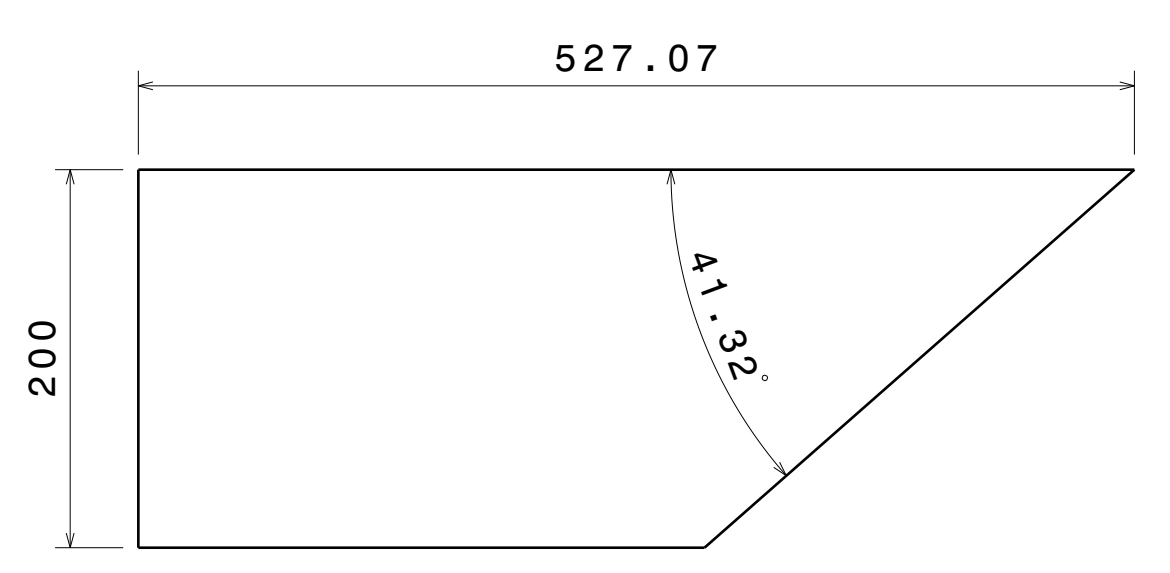

ITEM 16

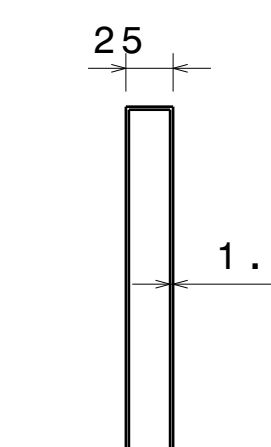

Right view
Scale: 1:4

UNLESS OTHERWISE SPECIFIED DIMENSION ARE IN MM
VIEWS: THIRD ANGLE PROJECTION

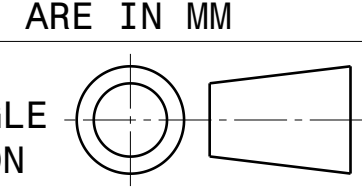

This drawing is our property. It can't be reproduced or communicated without our written agreement.

DRAWN BY	DATE
SB	26MAR2021
CHECKED BY	DATE
P2P Analysis & Solutions	26MAR2021
DESIGNED BY	DATE
P2P Analysis & Solutions	26MAR2021

APL APOLLO TUBES LTD.	
DRAWING TITLE	
GATE	
SIZE	DRAWING NUMBER
A0	P2P MAR 21-10
SCALE	WEIGHT (kg)
NONE	XXX
SHEET 3 OF 3	