

REV/DATE	DESCRIPTION
00 21MAY2021	INITIAL REVISION

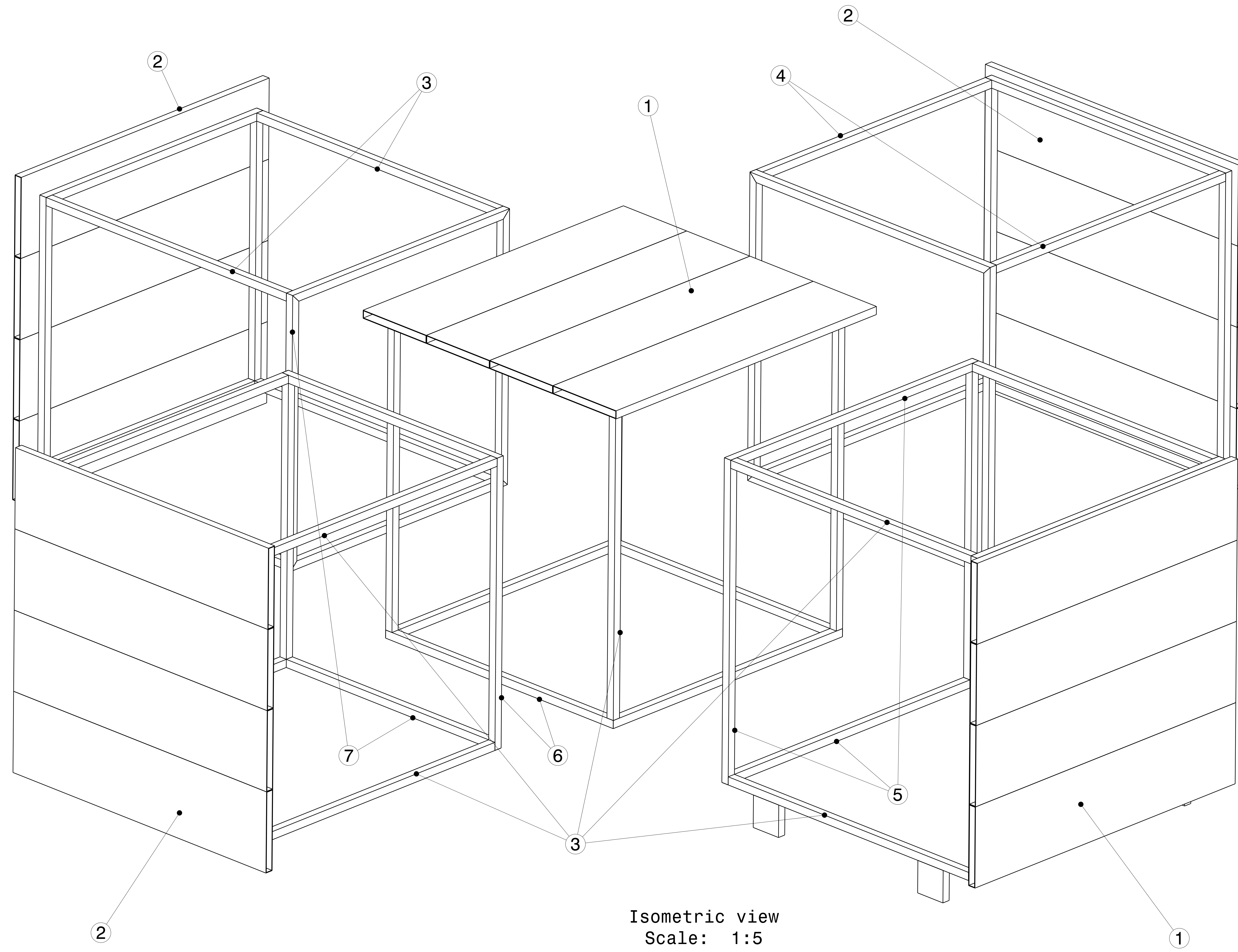

Isometric view  
Scale: 1:5  
EXPLODED VIEW

IT HAS 5 CHAIRS NESTED

NOTES:

- (⊥) ALL VERTICAL SUPPORTS ARE PERPENDICULAR.
- FLATNESS OF .5MM IS APPLIED BY DEFAULT.
- ⊘ WELD BEAD OF 2MM RADIUS IS FOLLOWED.
- ▽ SURFACE FINISH MEDIUM TO SMOOTH IS USED.
- ALL TUBES ARE AS PER APL APOLLO STANDARD. CHANGES MAY EFFECT THE LOAD CAPACITY.
- ALL HORIZONTAL AND VERTICAL TUBES ARE PERPENDICULAR TO EACH OTHER WITH ±1 DEG.
- FINE WELDING IS REQUIRED AS PER MENTIONED DETAILS AND FINISHING.
- HIGHER CURRENT WELDING MAY AFFECT THE BRITTLENESS OF MATERIAL WHICH LATER MAY RAISE TO WEAKENING OF STRUCTURE.
- FABRICATORS ARE ALLOWED TO USE FITTINGS/FRAMES/SUPPORTS AS NEEDED AND THE SAME MUST BE COMMUNICATED BACK TO ENGINEERING TEAM.
- BOP COMPONENT WEIGHTS ARE FOR REFERENCE ONLY AND SUBJECTED TO CHANGE PER PURCHASED COMPONENTS.

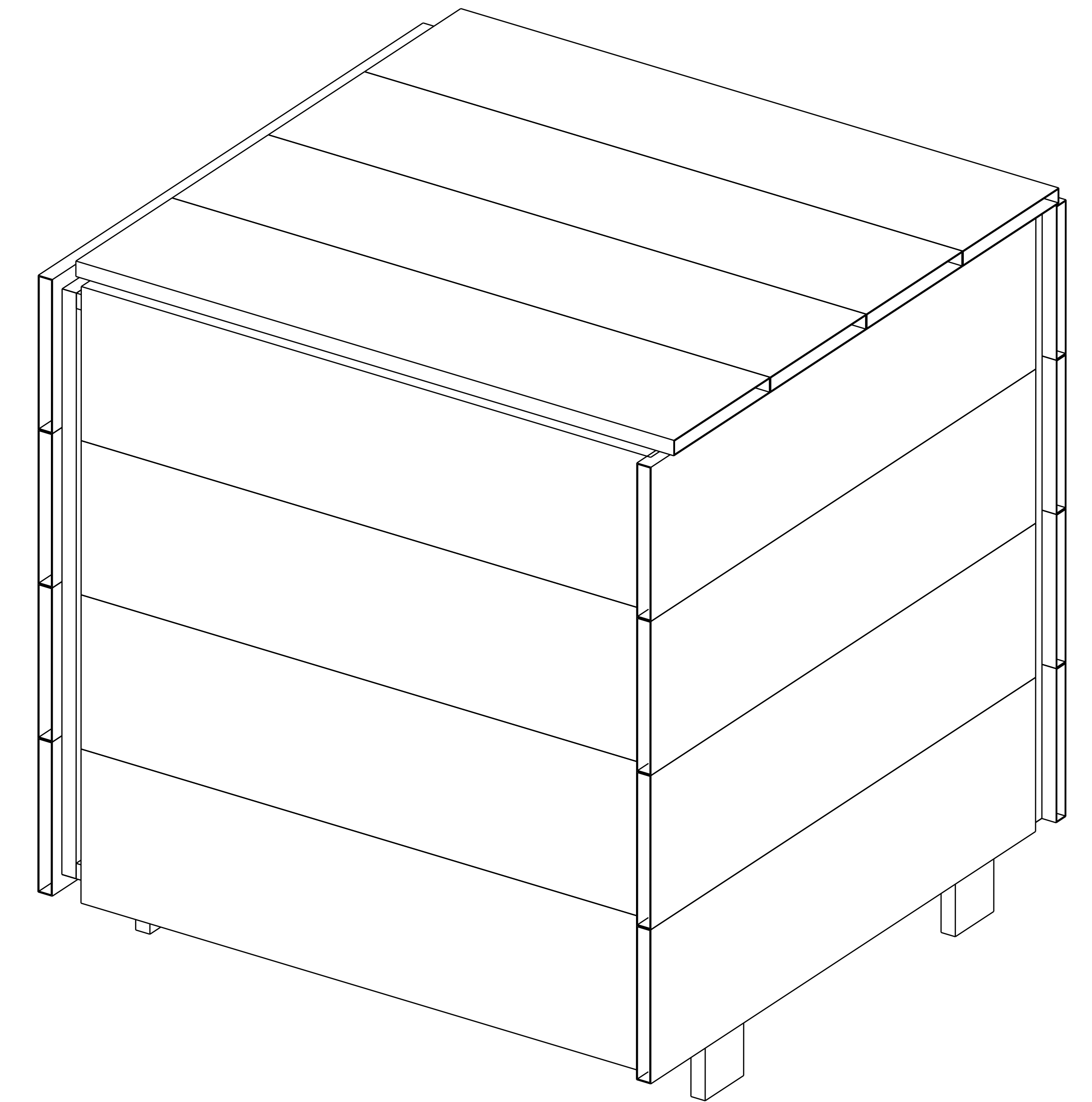

Isometric view  
Scale: 1:5  
CLOSED CONDITION

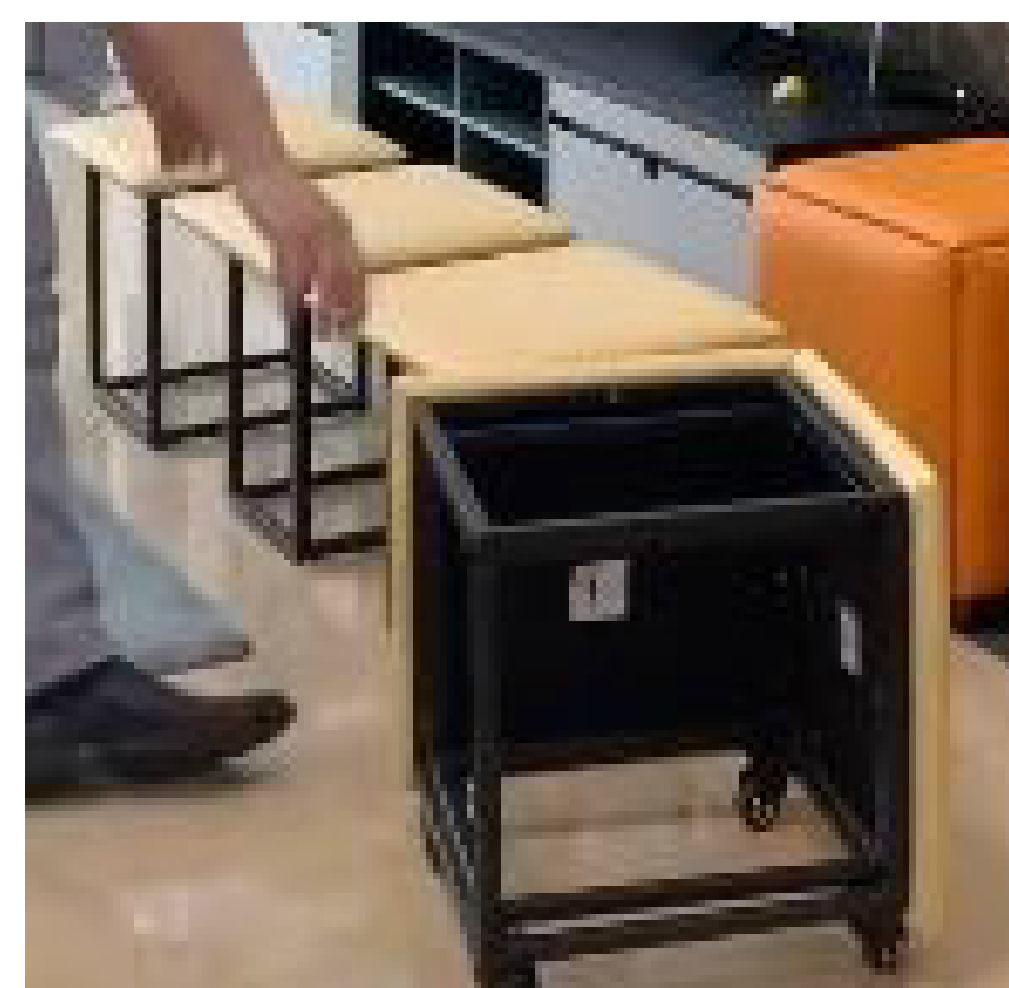

ITEM NO.	PART NUMBER	DESCRIPTION	QTY.	Wt (Kg) /Each
7	SHS 5	25 X 25 X 1.6 X 850	8	1.1
6	SHS 4	25 X 25 X 1.6 X 900	8	1.11
5	SHS 3	25 X 25 X 1.6 X 1000	12	1.13
4	SHS 2	25 X 25 X 1.6 X 925	12	1.11
3	SHS 1	25 X 25 X 1.6 X 950	20	1.12
2	PLANK 2	250 X 25 X 1.6 X 1000	12	6.85
1	PLANK 1	250 X 25 X 1.6 X 1050	8	7.2

This drawing is our property. It can't be reproduced or communicated without our written agreement. <a href="http://www.p2p.ind.in">www.p2p.ind.in</a>		<b>APL APOLLO TUBES LTD.</b>	
DRAWING TITLE		NESTED CHAIRS	
CHECKED BY	DATE	SIZE	DRAWING NUMBER
RR	21MAY2021	A0	P2P MAY 21-05
DESIGNED BY	DATE	SCALE	WEIGHT (kg)
P2P Analysis & Solutions	21MAY2021	As Indicated	0kg
		SHEET 1 OF 3	

UNLESS OTHERWISE SPECIFIED DIMENSION ARE IN MM  
VIEWS: THIRD ANGLE PROJECTION

REV	DATE	DESCRIPTION
00	21MAY2021	INITIAL REVISION

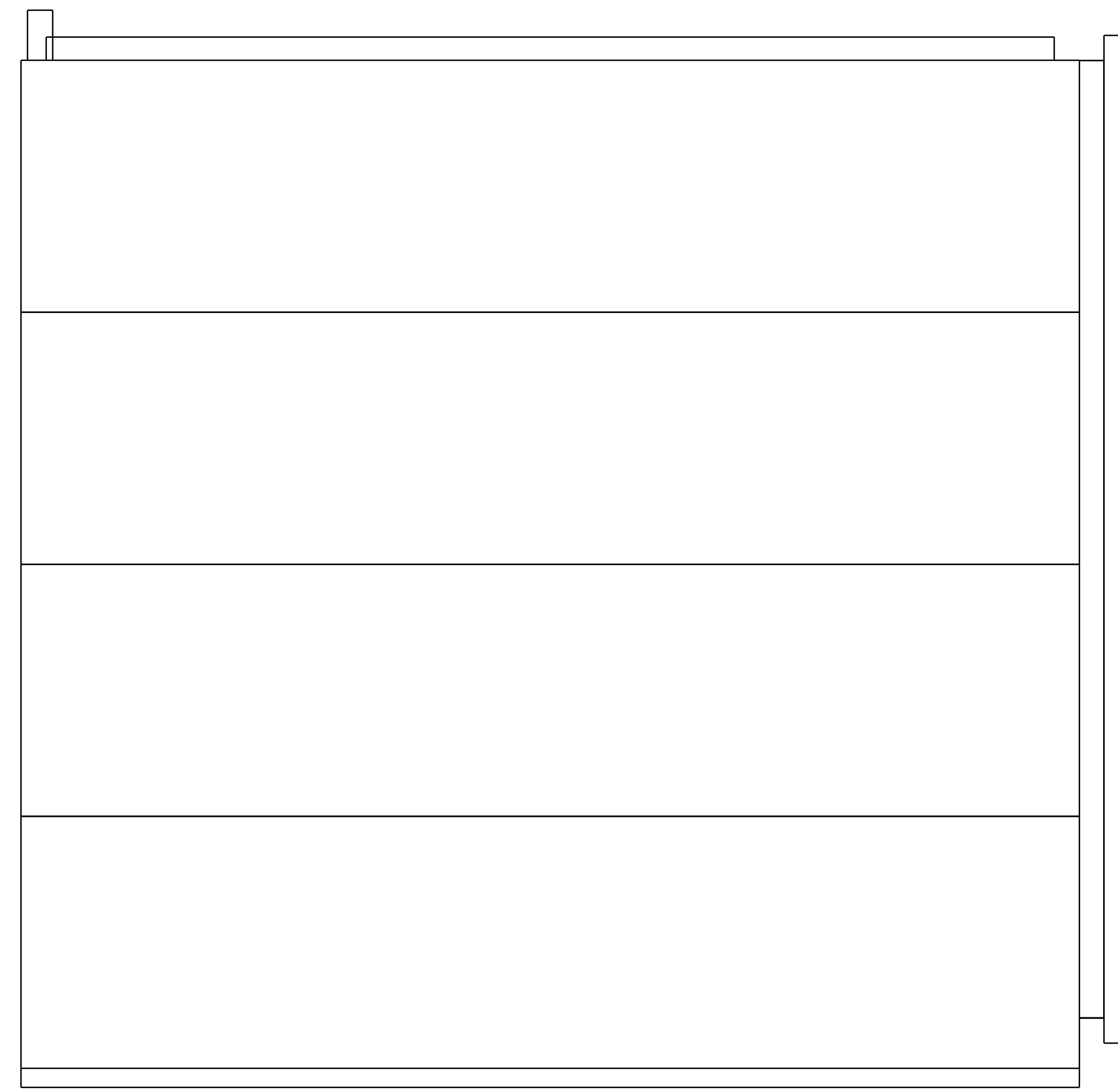

Top view  
Scale: 1:4

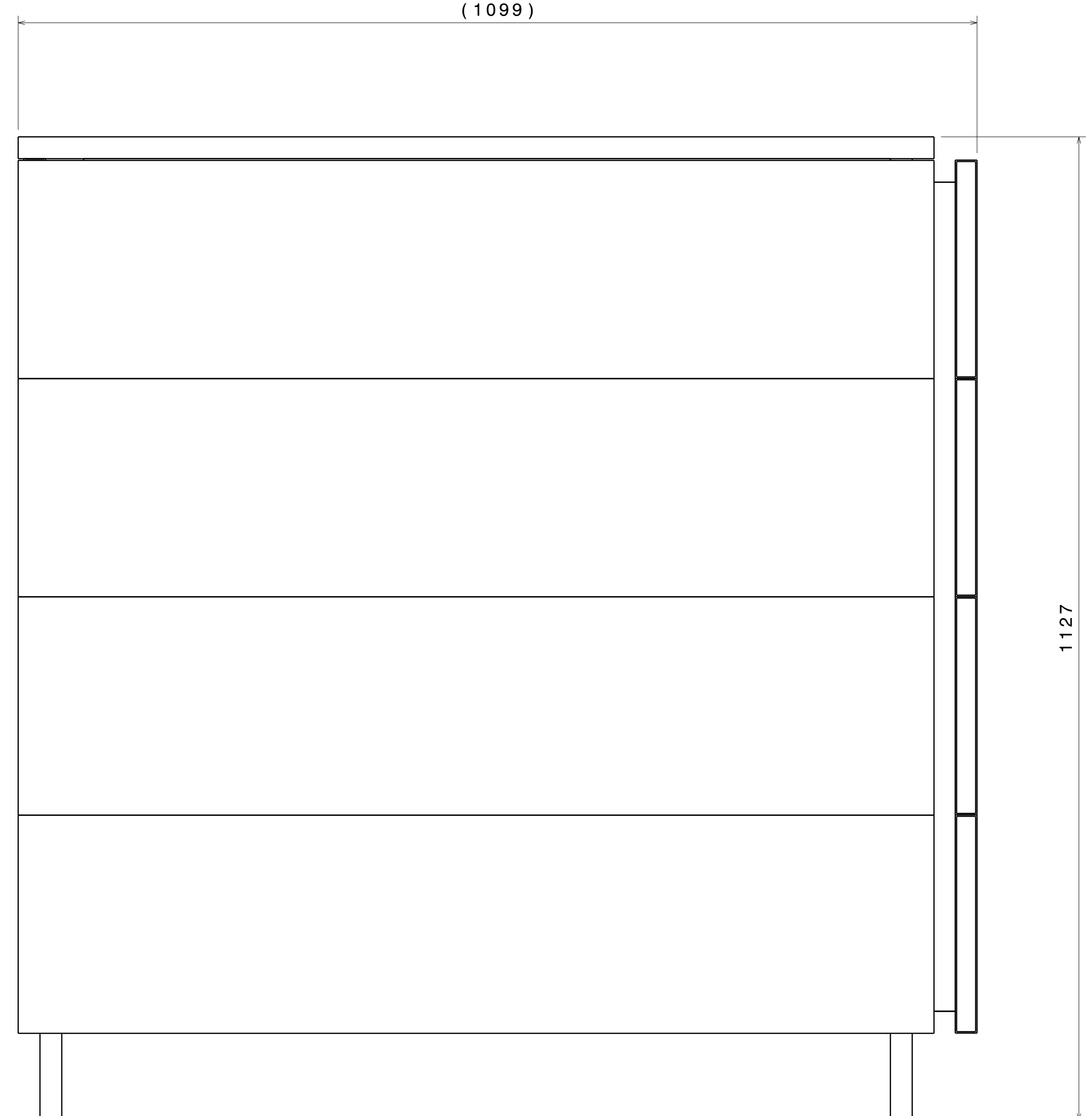

Front view  
Scale: 1:4

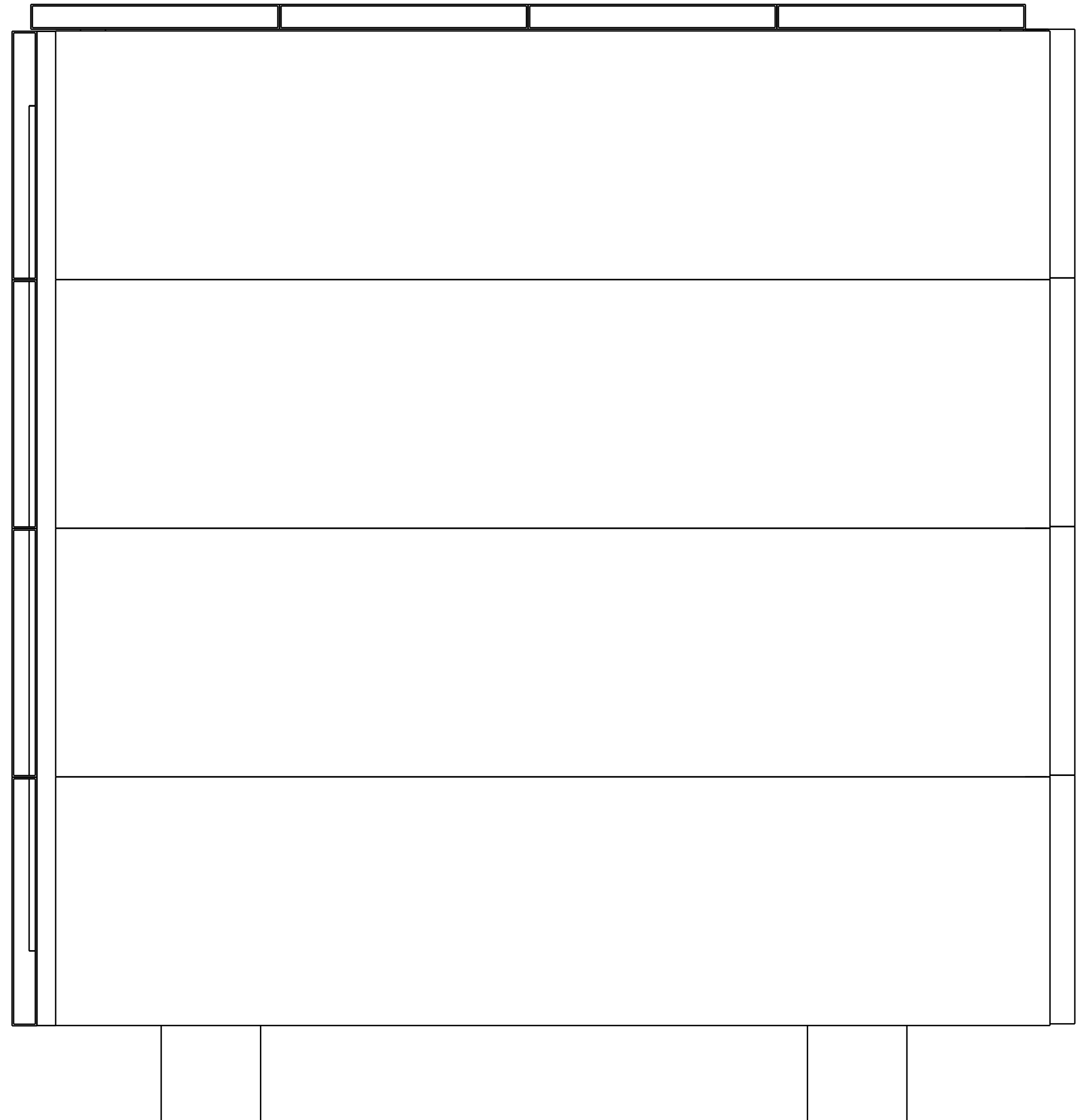

Right view  
Scale: 1:4

UNLESS OTHERWISE SPECIFIED DIMENSION ARE IN MM  
VIEWS: THIRD ANGLE PROJECTION

This drawing is our property. It can't be reproduced or communicated without our written agreement.  
www.p2p.ind.in

DRAWN BY	DATE
CHECKED BY	DATE
DESIGNED BY	DATE

APL APOLLO TUBES LTD.	
DRAWING TITLE	
NESTED CHAIRS	
SIZE	DRAWING NUMBER
A0	P2P MAY 21-05
SCALE	WEIGHT (kg)
NONE	XXX
REV	SHEET 2 OF 3
00	

REV	DATE	DESCRIPTION
00	21MAY2021	INITIAL REVISION

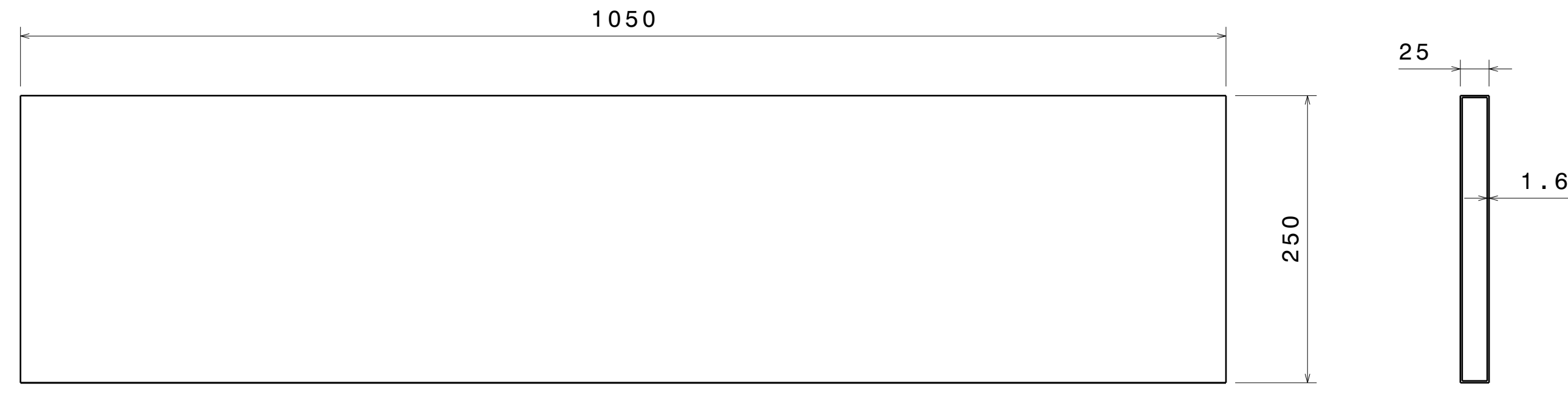

ITEM 1

Right view  
Scale: 1:4

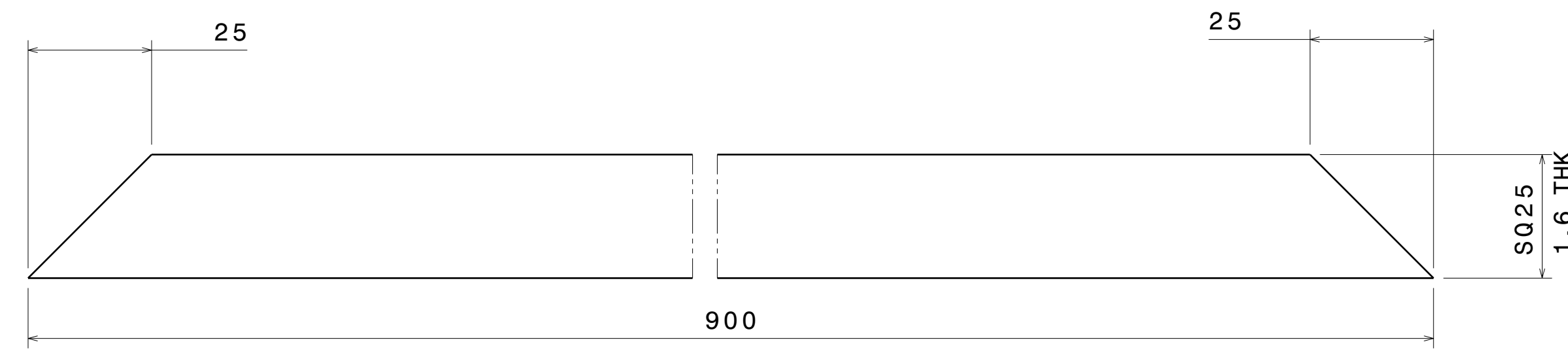

ITEM 6

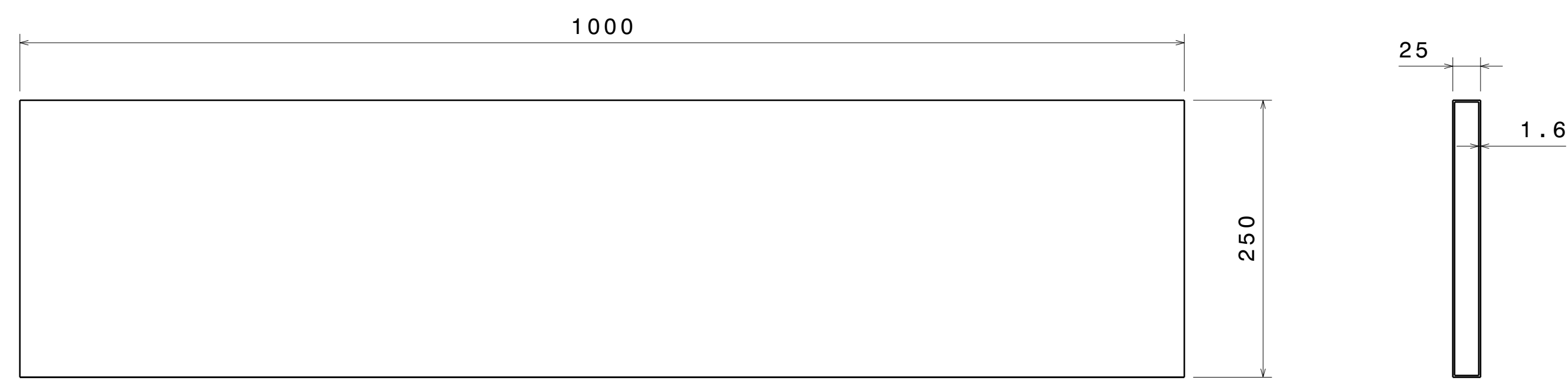

ITEM 2

Right view  
Scale: 1:4

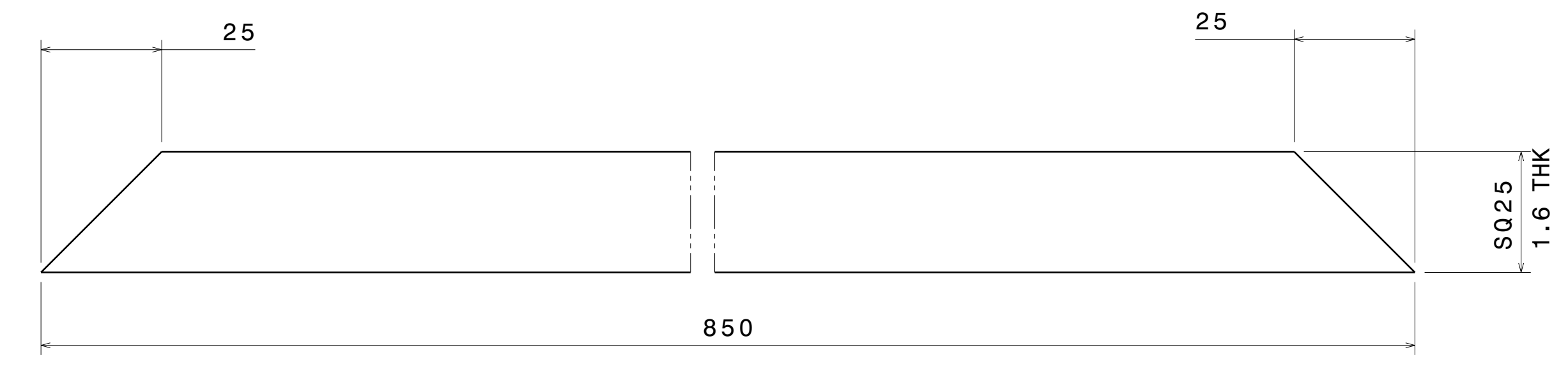

ITEM 7

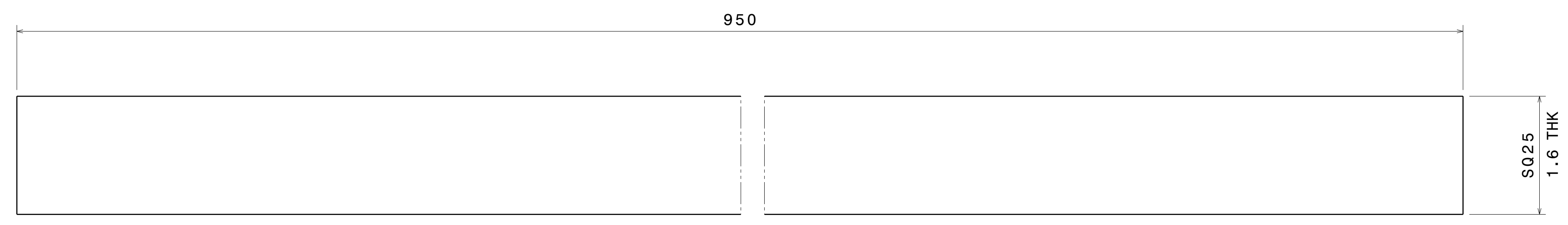

ITEM 3

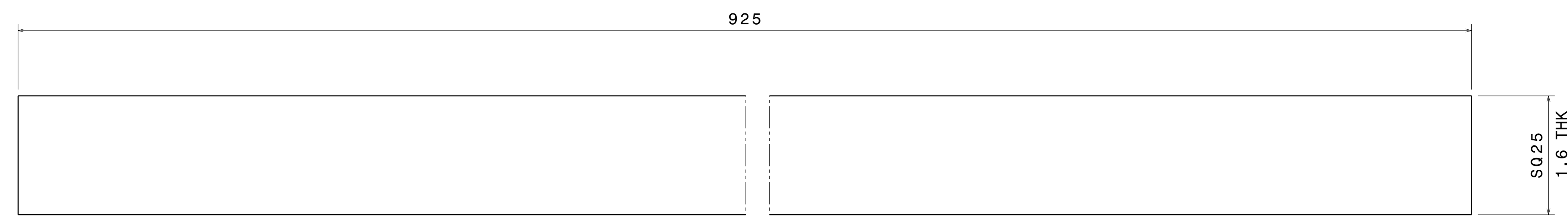

ITEM 4

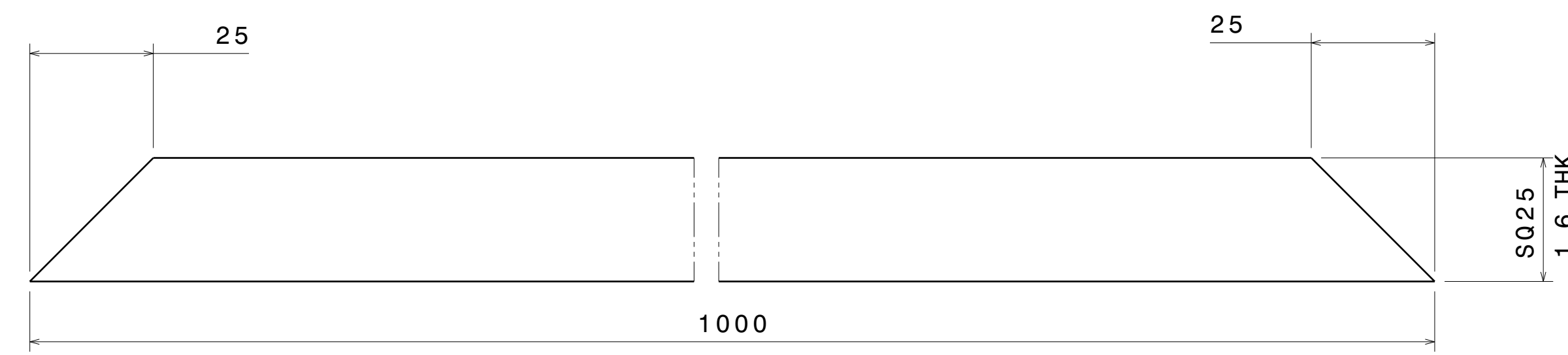

ITEM 5

ITEM 3, 4, 5, 6 & 7 LENGTH ARE SUBJECTED TO CHANGE IF REQUIRED WHILE FABRICATING

UNLESS OTHERWISE SPECIFIED DIMENSION ARE IN MM  
VIEWS: THIRD ANGLE PROJECTION

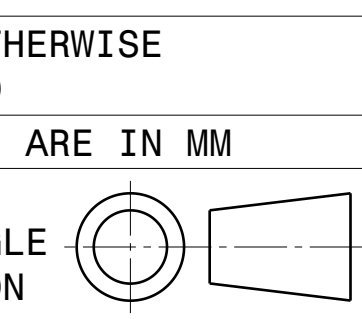

This drawing is our property. It can't be reproduced or communicated without our written agreement.  
www.p2p.ind.in

DRAWN BY	DATE
SB	21MAY2021
CHECKED BY	DATE
P2P Analysis & Solutions	21MAY2021
DESIGNED BY	DATE
P2P Analysis & Solutions	21MAY2021

APL APOLLO TUBES LTD. 	
DRAWING TITLE	
NESTED CHAIRS	
SIZE	DRAWING NUMBER
A0	P2P MAY 21-05
REV	00
SCALE	NONE
WEIGHT (kg)	XXX
SHEET 3 OF 3	