

REV	DATE	DESCRIPTION
00	12MAY2021	INITIAL REVISION

- NOTES:
- (⊥) ALL VERTICAL SUPPORTS ARE PERPENDICULAR.
 - FLATNESS OF .5MM IS APPLIED BY DEFAULT.
 - ⊲ WELD BEAD OF 2MM RADIUS IS FOLLOWED.
 - ▽ SURFACE FINISH MEDIUM TO SMOOTH IS USED.
 - ALL TUBES ARE AS PER APL APOLLO STANDARD. CHANGES MAY EFFECT THE LOAD CAPACITY.
 - ALL HORIZONTAL AND VERTICAL TUBES ARE PERPENDICULAR TO EACH OTHER WITH ±1 DEG.
 - FINE WELDING IS REQUIRED AS PER MENTIONED DETAILS AND FINISHING.
 - HIGHER CURRENT WELDING MAY AFFECT THE BRITTLENESS OF MATERIAL WHICH LATER MAY RAISE TO WEAKENING OF STRUCTURE.
 - FABRICATORS ARE ALLOWED TO USE FITTINGS/FRAMES/SUPPORTS AS NEEDED AND THE SAME MUST BE COMMUNICATED BACK TO ENGINEERING TEAM.
 - BOP COMPONENT WEIGHTS ARE FOR REFERENCE ONLY AND SUBJECTED TO CHANGE PER PURCHASED COMPONENTS.

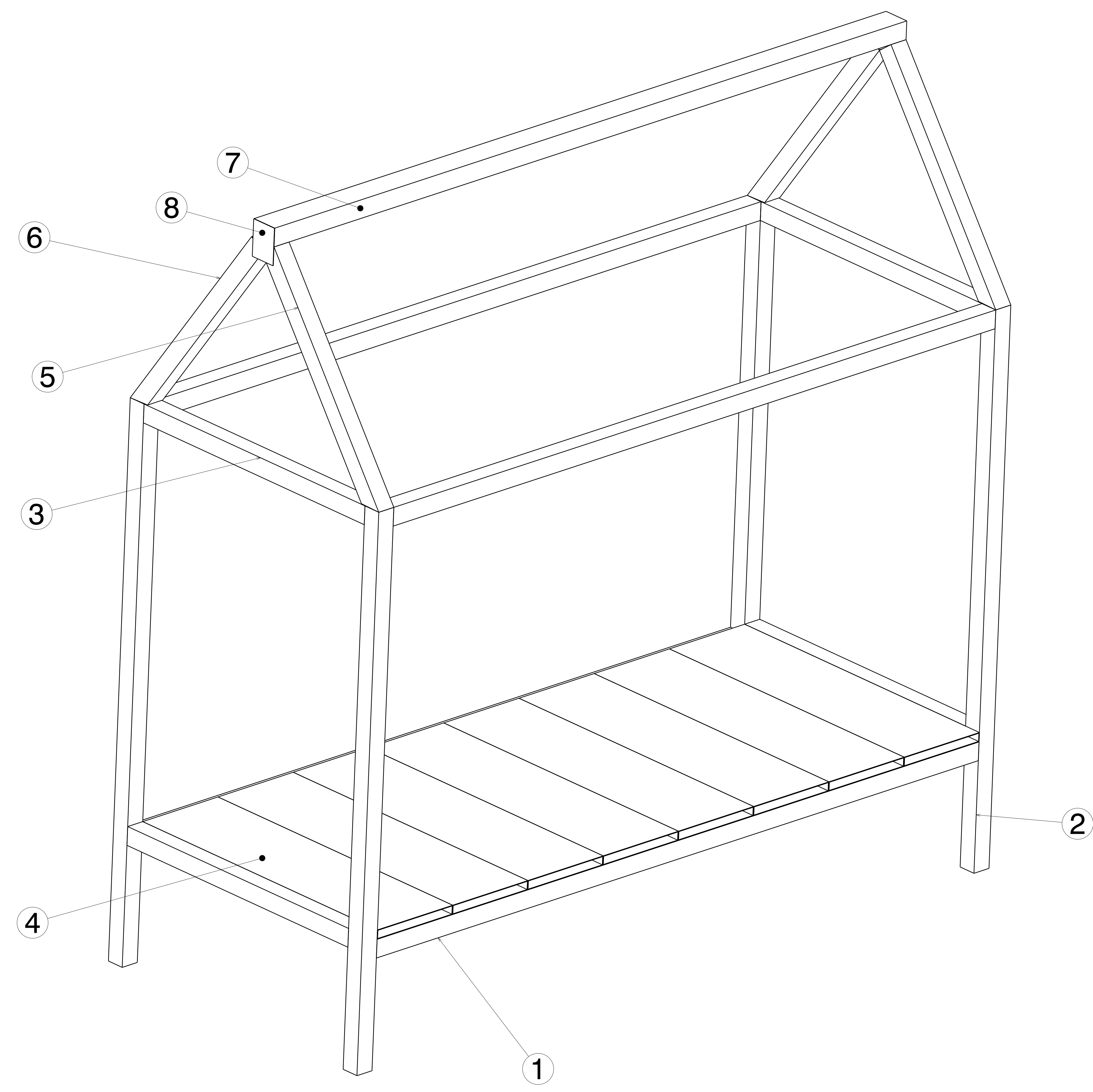

Isometric view
Scale: 1:5

ITEM NO.	PART NUMBER	DESCRIPTION	QTY.	Wt (Kg)/Each
8	COVER PLATE - BOP	-----	2	-----
7	RHS FRAME 6	75 X 50 X 2 X 2100	1	6.45
6	RHS FRAME 5	50 X 25 X 2 X 700	2	1.20
5	RHS FRAME 4	50 X 25 X 2 X 700	2	1.20
4	PLANK 1	200 X 25 X 1.6 X 850	8	5.80
3	RHS FRAME 3	50 X 25 X 2 X 800	4	1.80
2	RHS FRAME 2	50 X 25 X 2 X 1500	4	3.35
1	RHS FRAME 1	50 X 25 X 2 X 2000	4	4.45

This drawing is our property. It can't be reproduced or communicated without our written agreement. www.p2p.ind.in		APL APOLLO TUBES LTD.	
DRAWN BY RR		DRAWING TITLE BED	
CHECKED BY P2P Analysis & Solutions		DATE 12MAY2021	
DESIGNED BY P2P Analysis & Solutions		DATE 12MAY2021	
UNLESS OTHERWISE SPECIFIED DIMENSION ARE IN MM	THIRD ANGLE PROJECTION	SIZE A0	DRAWING NUMBER P2P MAY 21-15
		SCALE As Indicated	WEIGHT(kg) xxxx
		SHEET 1 OF 3	

UNLESS OTHERWISE SPECIFIED DIMENSION ARE IN MM

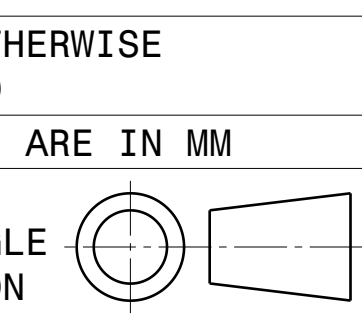

REV	DATE	DESCRIPTION
00	12MAY2021	INITIAL REVISION

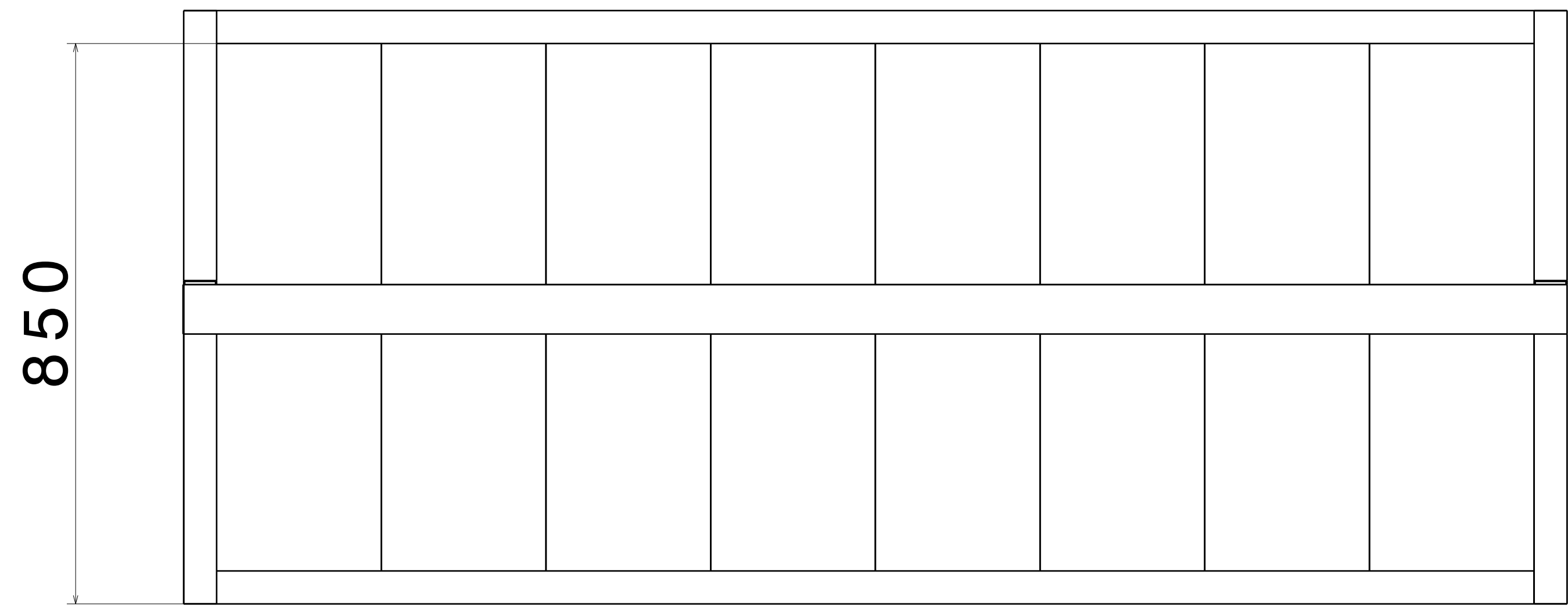

Top view
Scale: 3:20

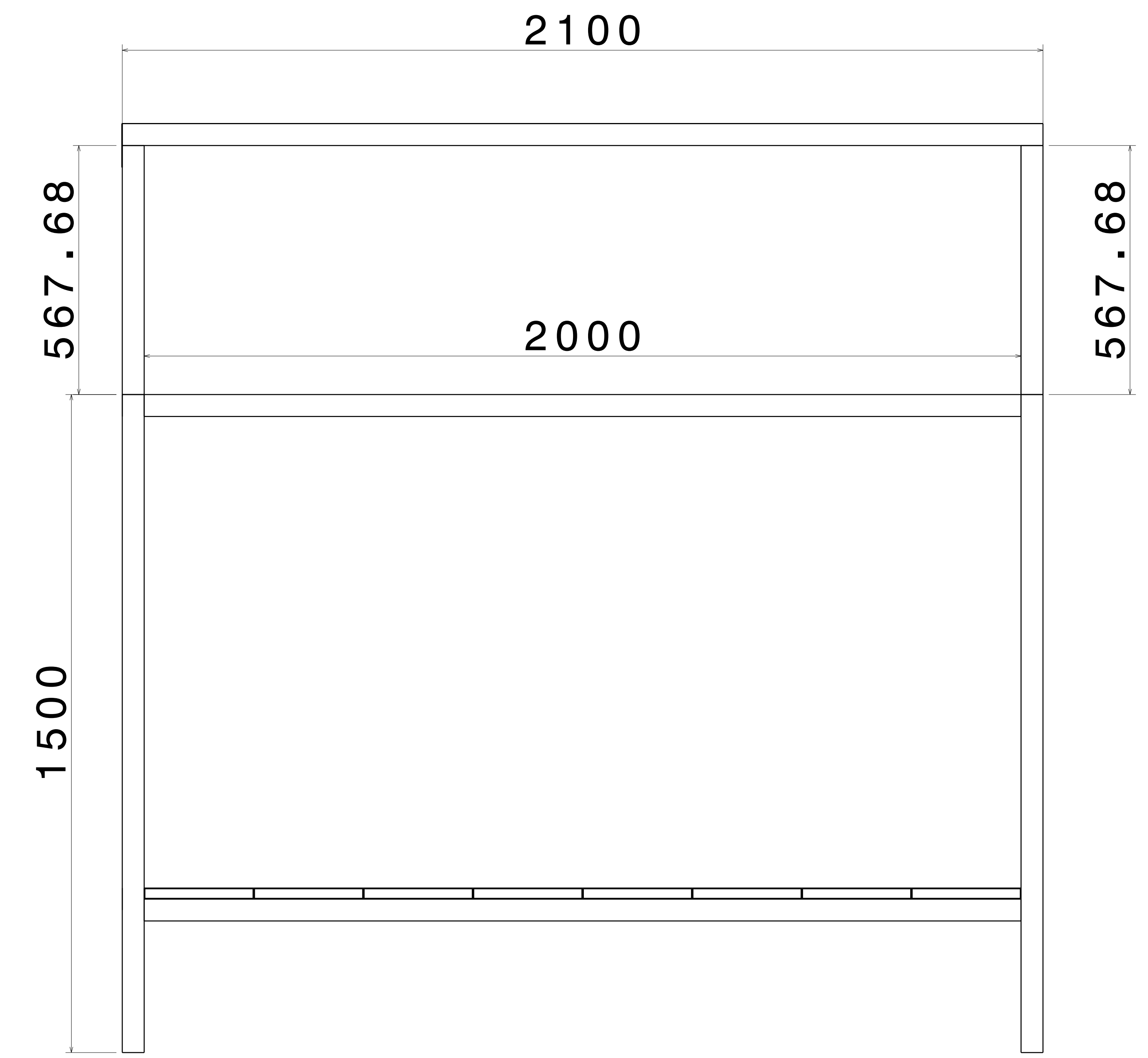

Front view
Scale: 3:20

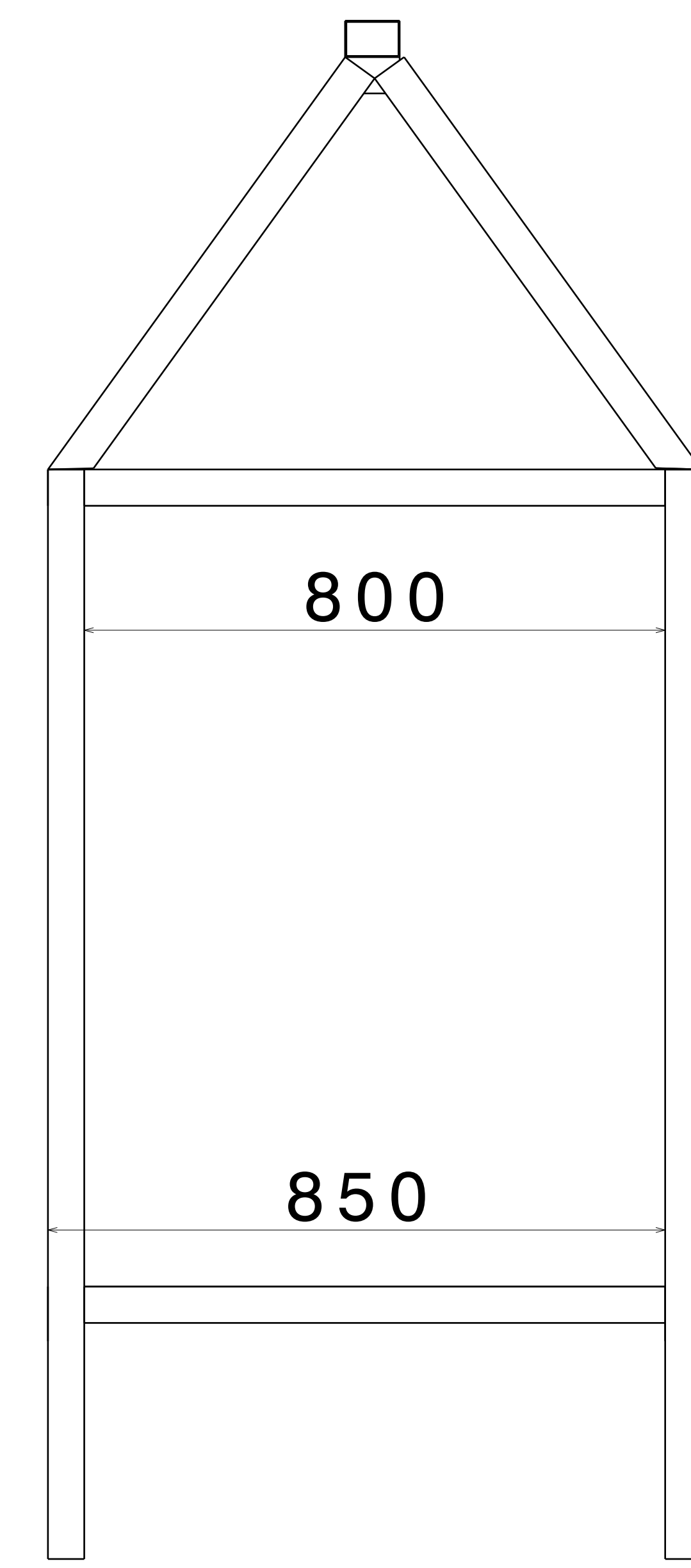

Right view
Scale: 3:20

This drawing is our property.
It can't be reproduced
or communicated without
our written agreement.
www.p2p.ind.in

APL APOLLO TUBES LTD. 

DRAWN BY	DATE
SB	12MAY2021
CHECKED BY	DATE
P2P Analysis & Solutions	12MAY2021
DESIGNED BY	DATE
P2P Analysis & Solutions	12MAY2021

DRAWING TITLE		BED		REV
SIZE	DRAWING NUMBER			00
A0	P2P MAY 21-15			
SCALE	NONE	WEIGHT (kg)	XXX	SHEET 2 OF 3

UNLESS OTHERWISE SPECIFIED
DIMENSION ARE IN MM
VIEWS:
THIRD ANGLE PROJECTION

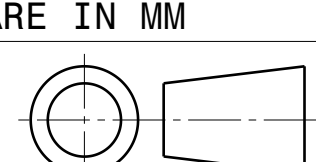

REV	DATE	DESCRIPTION
00	12MAY2021	INITIAL REVISION

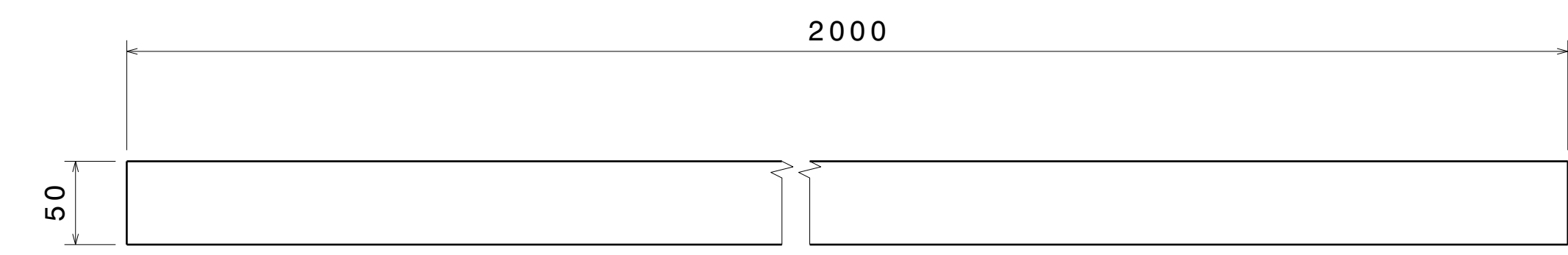

ITEM 1

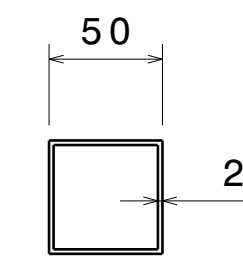

Right view
Scale: 3:10

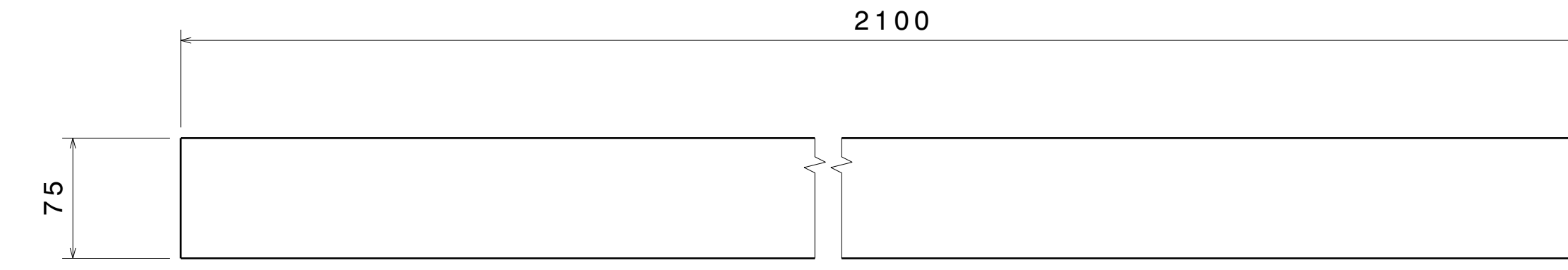

ITEM 7

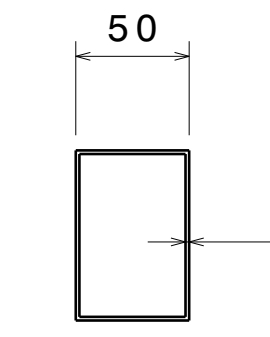

Right view
Scale: 3:10

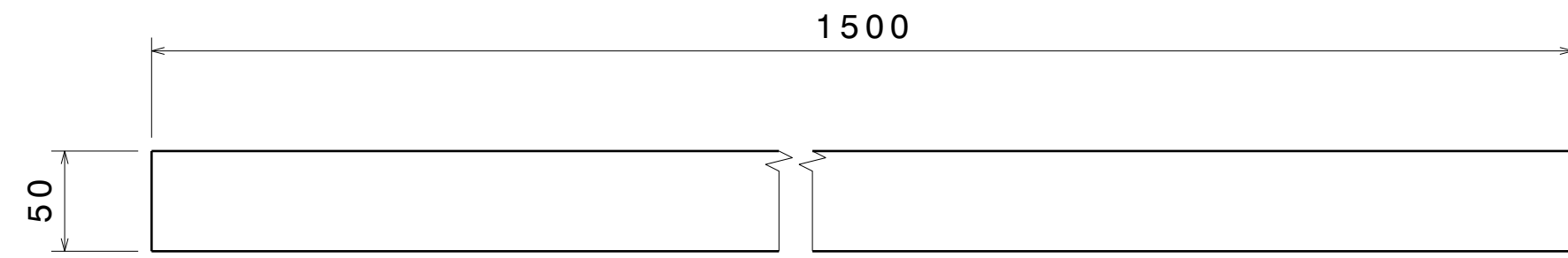

ITEM 2

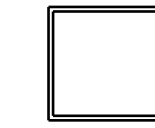

Right view
Scale: 3:10

NOTE :- ITEM NUMBER 1,2,3,5,6,7 ALL RIGHT VIEWS ARE THE SAME

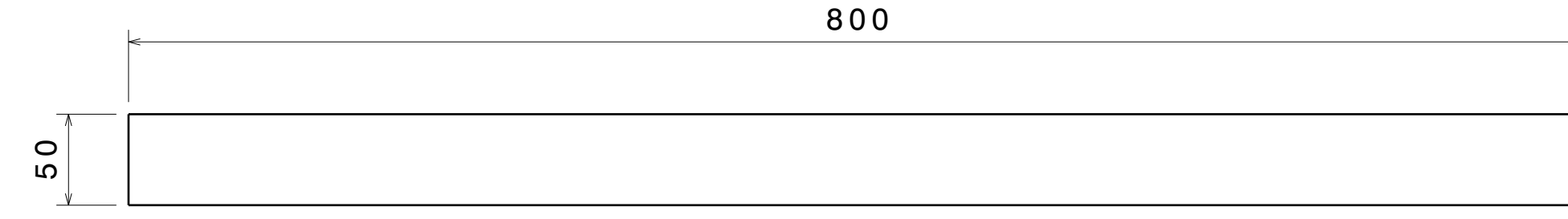

ITEM 3

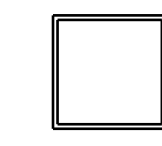

Right view
Scale: 3:10

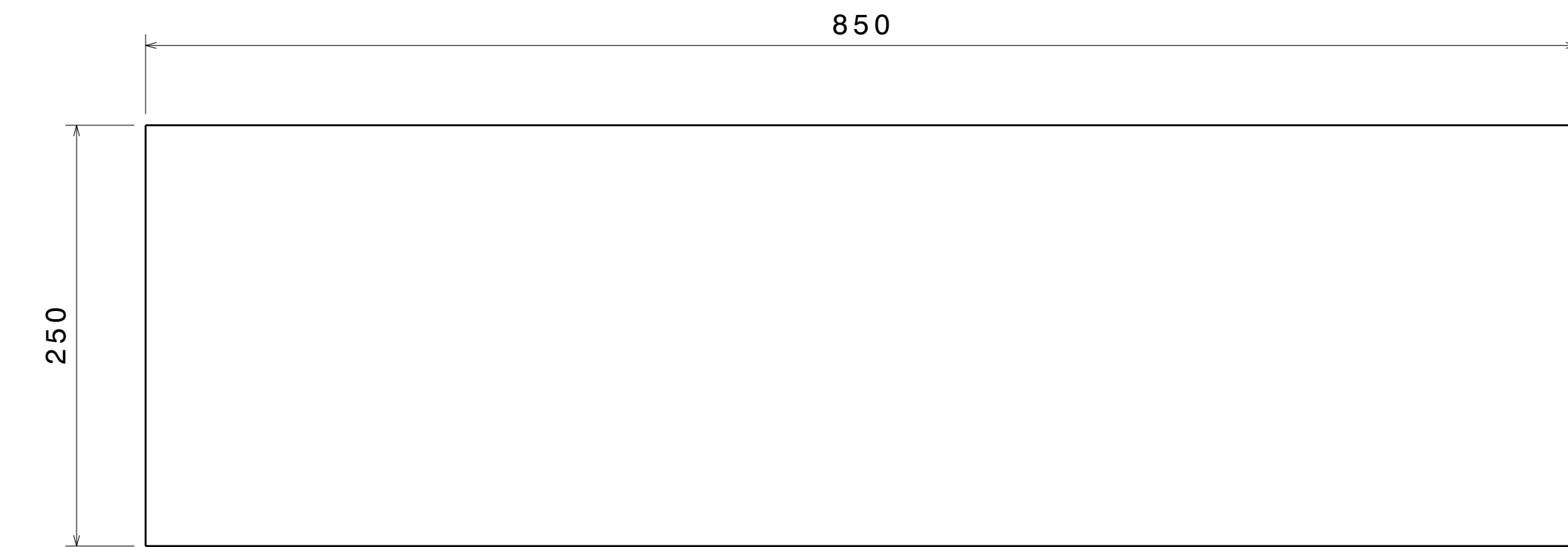

ITEM 4

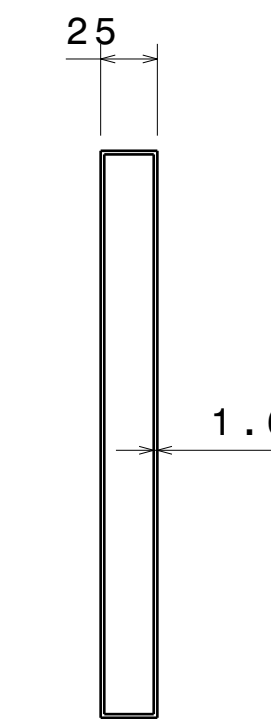

Right view
Scale: 3:10

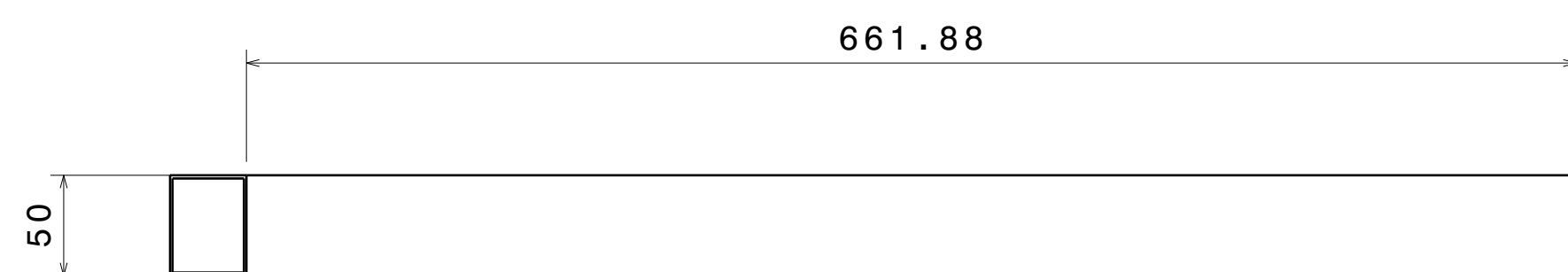

ITEM 5

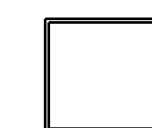

Right view
Scale: 3:10

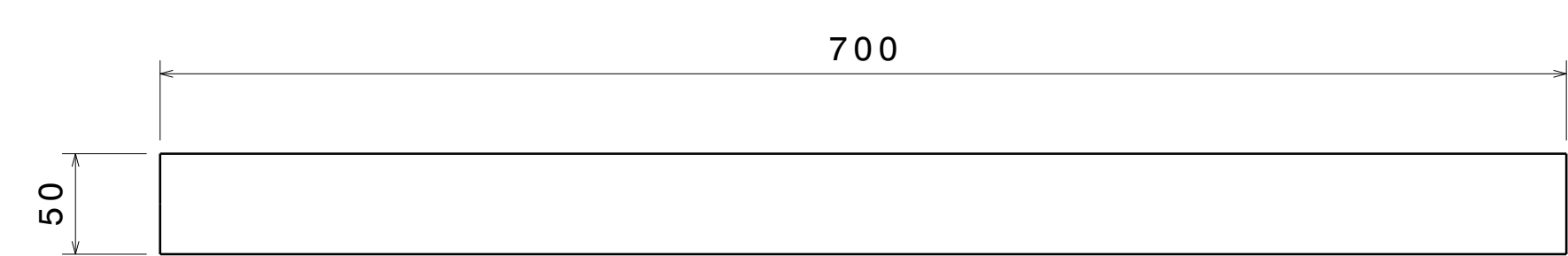

ITEM 6

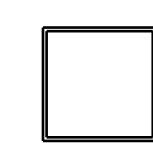

Right view
Scale: 3:10

UNLESS OTHERWISE SPECIFIED DIMENSION ARE IN MM
VIEWS: THIRD ANGLE PROJECTION

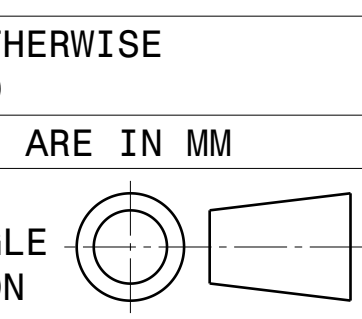

This drawing is our property. It can't be reproduced or communicated without our written agreement.
www.p2p.ind.in

DRAWN BY	SB	DATE	12MAY2021
CHECKED BY	P2P Analysis & Solutions	DATE	12MAY2021
DESIGNED BY	P2P Analysis & Solutions	DATE	12MAY2021

APL APOLLO TUBES LTD.	
DRAWING TITLE	
BED	
SIZE	A0
DRAWING NUMBER	P2P MAY 21-15
REV	00
SCALE	NONE
WEIGHT (kg)	XXX
SHEET 3 OF 3	