

REV/DATE	DESCRIPTION
00 12MAY2021	INITIAL REVISION

- NOTES:
- (⊥) ALL VERTICAL SUPPORTS ARE PERPENDICULAR.
  - FLATNESS OF .5MM IS APPLIED BY DEFAULT.
  - ⊞ WELD BEAD OF 2MM RADIUS IS FOLLOWED.
  - ▽▽ SURFACE FINISH MEDIUM TO SMOOTH IS USED.
  - ALL TUBES ARE AS PER APL APOLLO STANDARD. CHANGES MAY EFFECT THE LOAD CAPACITY.
  - ALL HORIZONTAL AND VERTICAL TUBES ARE PERPENDICULAR TO EACH OTHER WITH ±1 DEG.
  - FINE WELDING IS REQUIRED AS PER MENTIONED DETAILS AND FINISHING.
  - HIGHER CURRENT WELDING MAY AFFECT THE BRITTLNESS OF MATERIAL WHICH LATER MAY RAISE TO WEAKENING OF STRUCTURE.
  - FABRICATORS ARE ALLOWED TO USE FITTINGS/FRAMES/SUPPORTS AS NEEDED AND THE SAME MUST BE COMMUNICATED BACK TO ENGINEERING TEAM.
  - BOP COMPONENT WEIGHTS ARE FOR REFERENCE ONLY AND SUBJECTED TO CHANGE PER PURCHASED COMPONENTS.

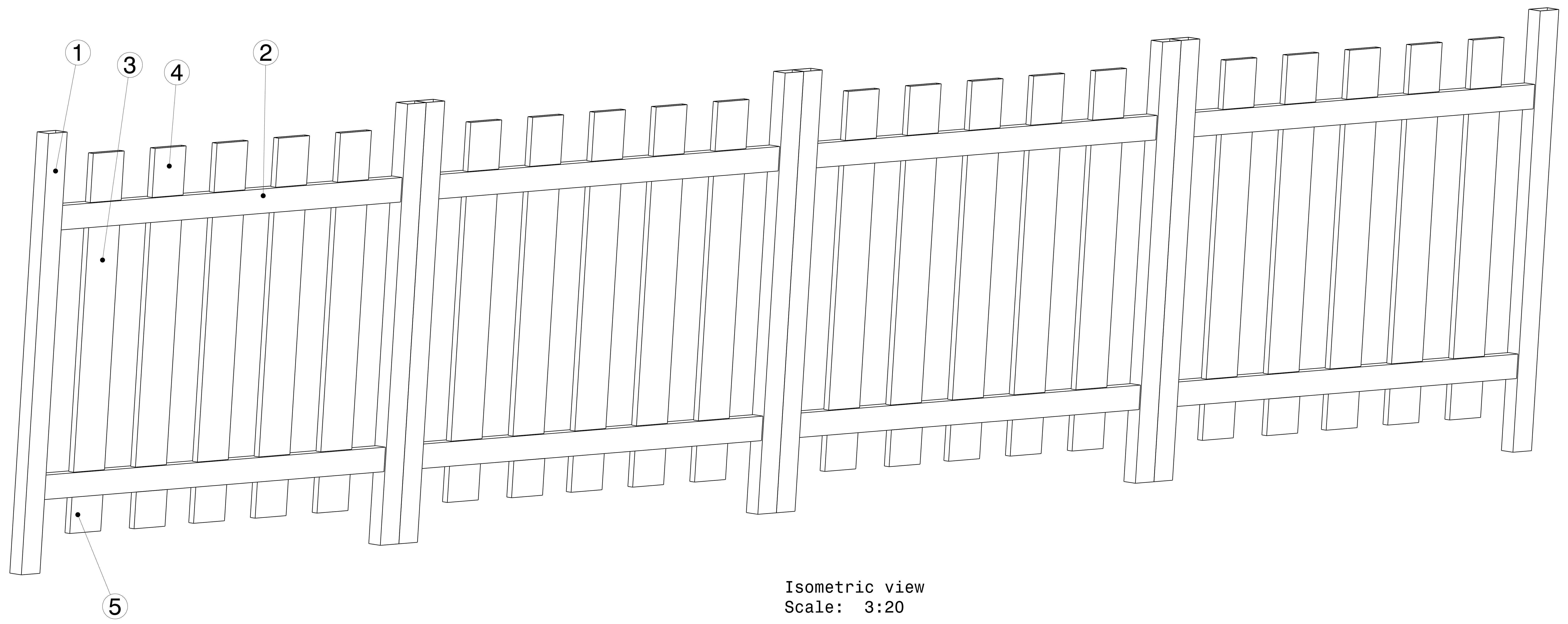

ITEM NO.	PART NUMBER	DESCRIPTION	QTY.	Wt(Kg)/Each
5	PLANK 3	200 X 25 X 1.6 X 150	20	0.85
4	PLANK 2	200 X 25 X 1.6 X 200	20	1.10
3	PLANK 1	200 X 25 X 1.6 X 1000	20	5.60
2	RHS FRAME 2	100 X 50 X 2 X 2200	8	10
1	RHS FRAME 1	120 X 60 X 2 X 1800	8	9.95

This drawing is our property. It can't be reproduced or communicated without our written agreement.  
www.p2p.ind.in

APL APOLLO TUBES LTD.

DRAWING TITLE: BOUNDARY DESIGN

DRAWN BY: RR	DATE: 12MAY2021	SIZE: A0	DRAWING NUMBER: P2P MAY 21-16	REV: 00
CHECKED BY: P2P Analysis & Solutions	DATE: 12MAY2021	SCALE: As Indicated	WEIGHT(kg) xxxx	SHEET 1 OF 3
DESIGNED BY: P2P Analysis & Solutions	DATE: 12MAY2021			

UNLESS OTHERWISE SPECIFIED DIMENSION ARE IN MM  
VIEWS: THIRD ANGLE PROJECTION

REV	DATE	DESCRIPTION
00	12MAY2021	INITIAL REVISION

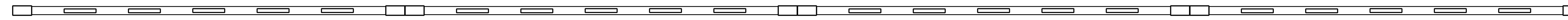

Top view  
Scale: 7:100

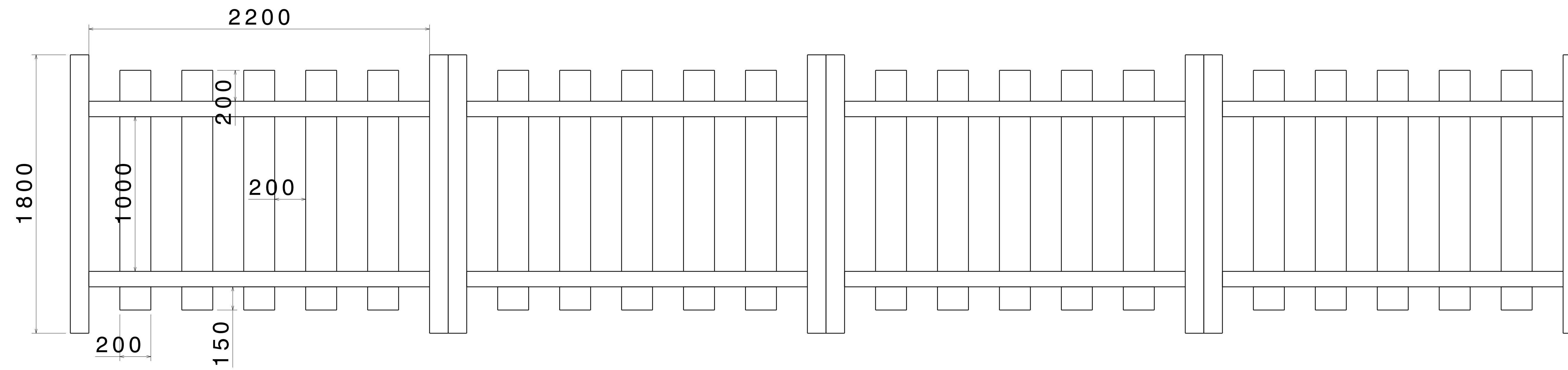

Front view  
Scale: 7:100

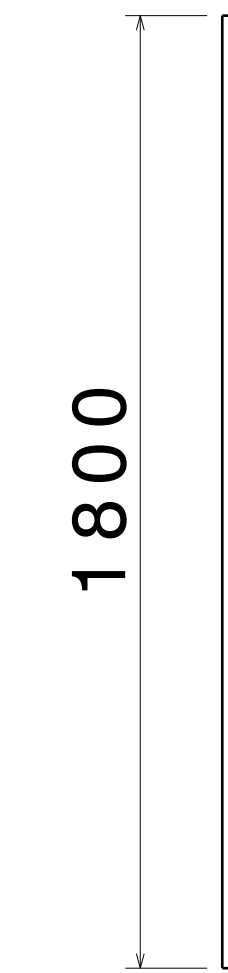

Right view  
Scale: 7:100

UNLESS OTHERWISE SPECIFIED DIMENSION ARE IN MM  
VIEWS: THIRD ANGLE PROJECTION

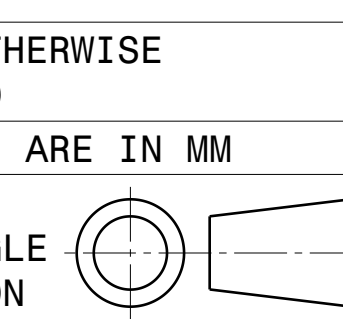

This drawing is our property. It can't be reproduced or communicated without our written agreement.  
www.p2p.ind.in

DRAWN BY	DATE
SB	12MAY2021
CHECKED BY	DATE
P2P Analysis & Solutions	12MAY2021
DESIGNED BY	DATE
P2P Analysis & Solutions	12MAY2021

APL APOLLO TUBES LTD. 	
DRAWING TITLE	
BOUNDARY DESIGN	
SIZE	DRAWING NUMBER
A0	P2P MAY 21-16
SCALE	WEIGHT (kg)
NONE	XXX
REV	SHEET 2 OF 3
00	

REV	DATE	DESCRIPTION
00	12MAY2021	INITIAL REVISION

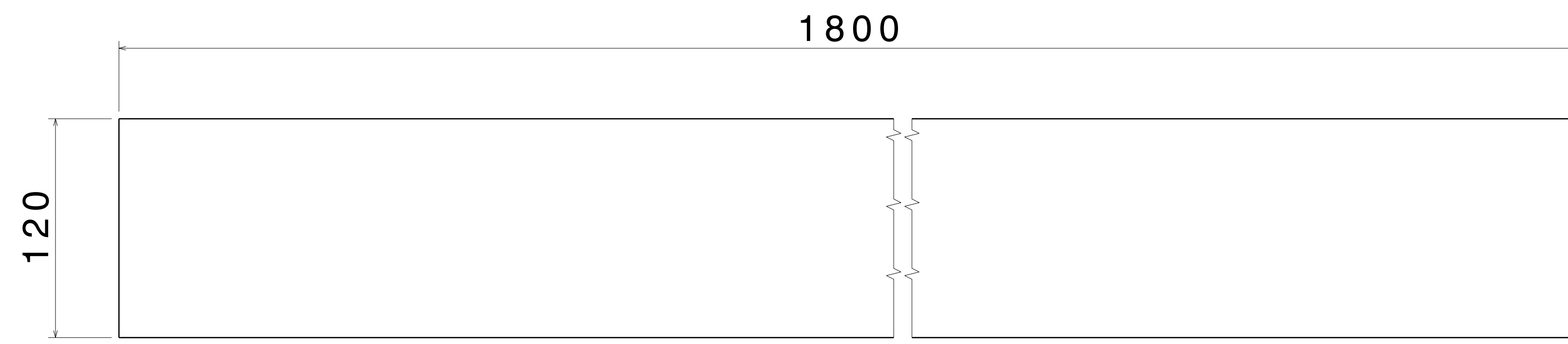

ITEM 1

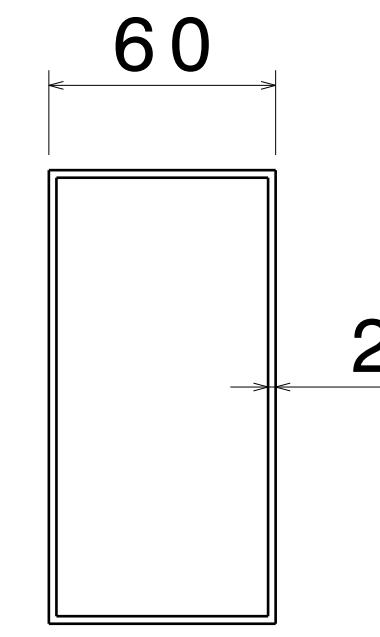

Right view  
Scale: 1:2

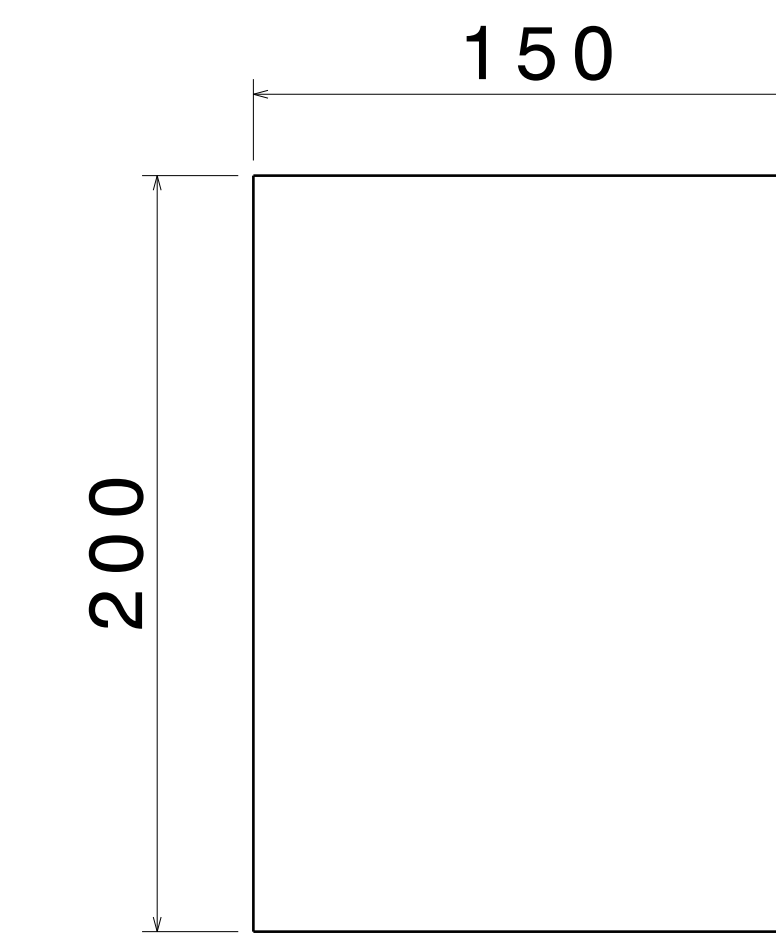

ITEM 5

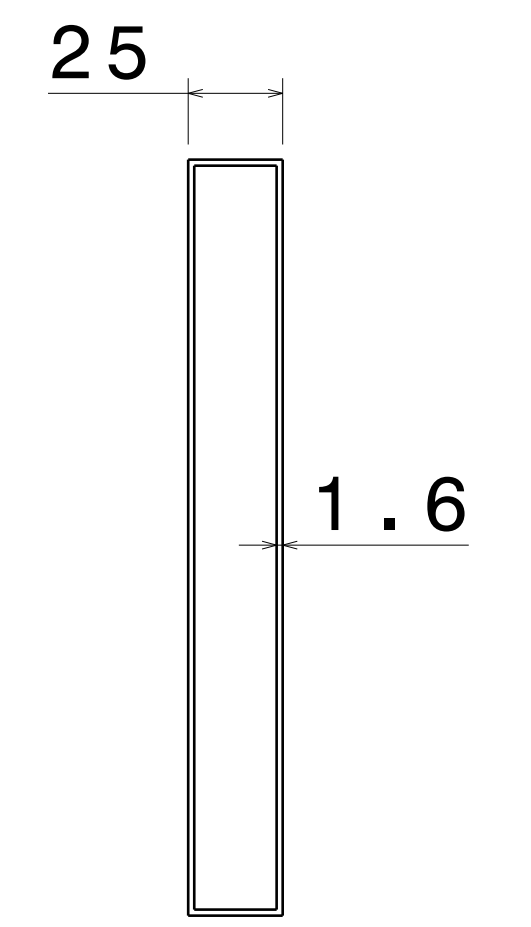

Right view  
Scale: 1:2

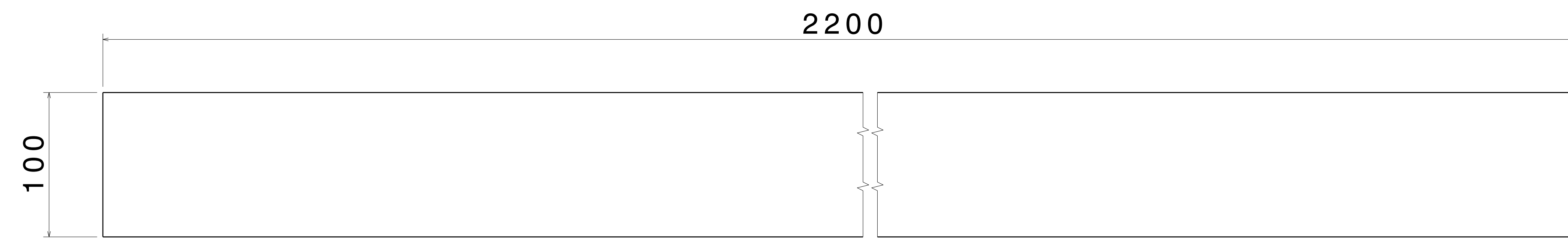

ITEM 2

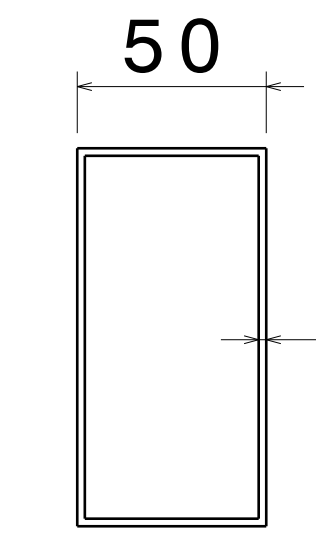

Right view  
Scale: 1:2

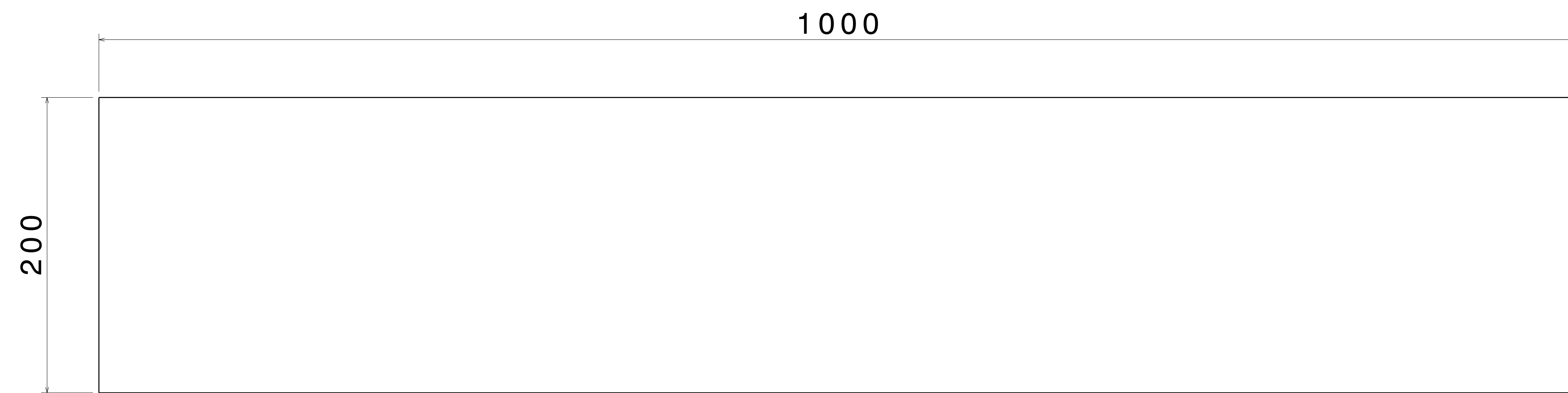

ITEM 3

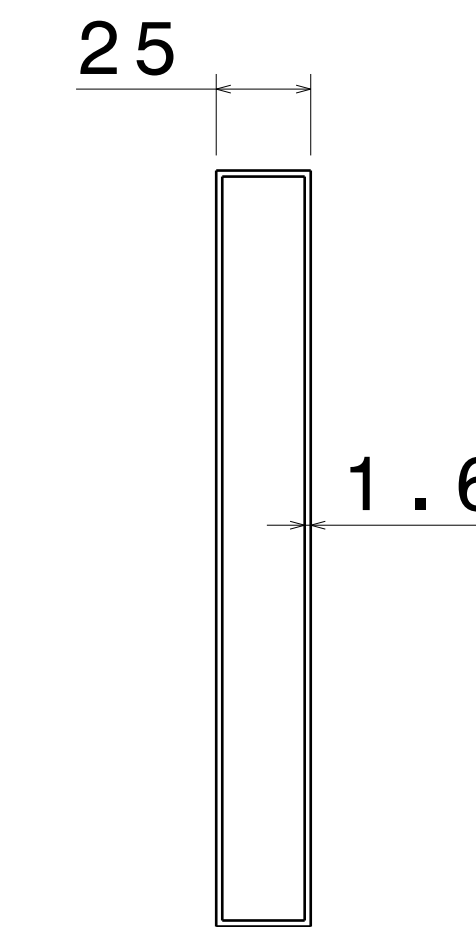

Right view  
Scale: 1:2

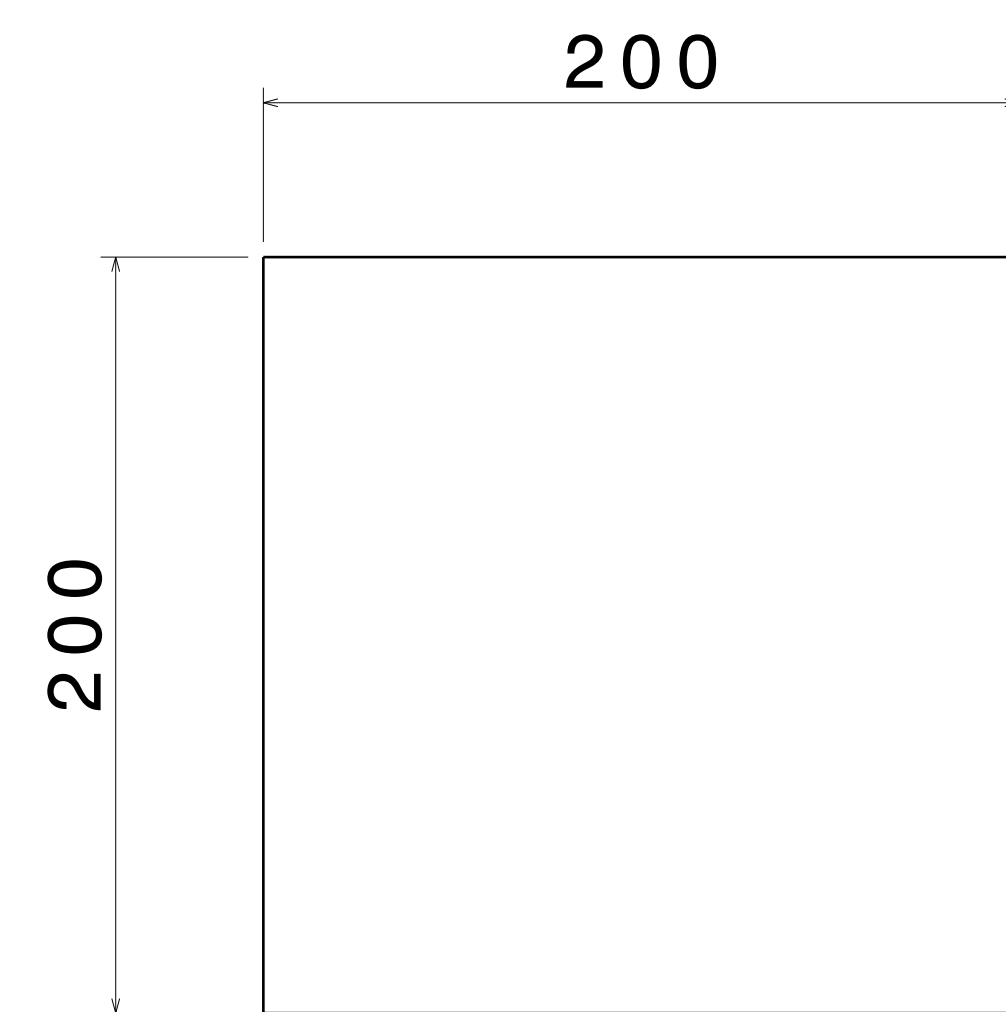

ITEM 4

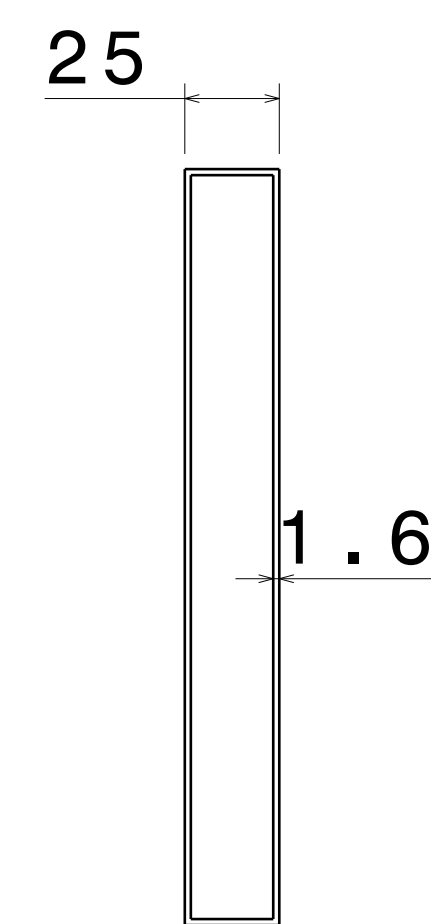

Right view  
Scale: 1:2

UNLESS OTHERWISE SPECIFIED DIMENSION ARE IN MM  
VIEWS: THIRD ANGLE PROJECTION

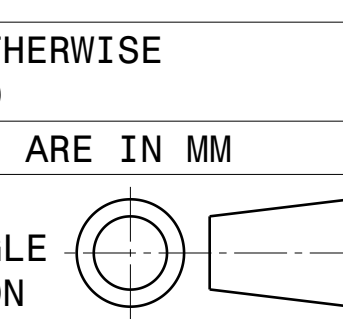

This drawing is our property. It can't be reproduced or communicated without our written agreement.  
www.p2p.ind.in

DRAWN BY	DATE
SB	12MAY2021
CHECKED BY	DATE
P2P Analysis & Solutions	12MAY2021
DESIGNED BY	DATE
P2P Analysis & Solutions	12MAY2021

APL APOLLO TUBES LTD. 	
DRAWING TITLE	
BOUNDARY DESIGN	
SIZE	DRAWING NUMBER
A0	P2P MAY 21-16
SCALE	WEIGHT (kg)
NONE	XXX
REV	SHEET 3 OF 3
00	