

REV	DATE	DESCRIPTION
00	20MAY2021	INITIAL REVISION

NOTES:

1. (⊥) ALL VERTICAL SUPPORTS ARE PERPENDICULAR.
2. □ FLATNESS OF .5MM IS APPLIED BY DEFAULT.
3. ⚡ WELD BEAD OF 2MM RADIUS IS FOLLOWED.
4. ∇ SURFACE FINISH MEDIUM TO SMOOTH IS USED.
5. ALL TUBES ARE AS PER APL APOLLO STANDARD. CHANGES MAY EFFECT THE LOAD CAPACITY.
6. ALL HORIZONTAL AND VERTICAL TUBES ARE PERPENDICULAR TO EACH OTHER WITH ±1 DEG.
7. FINE WELDING IS REQUIRED AS PER MENTIONED DETAILS AND FINISHING.
8. HIGHER CURRENT WELDING MAY AFFECT THE BRITTLENESS OF MATERIAL WHICH LATER MAY RAISE TO WEAKENING OF STRUCTURE.
9. FABRICATORS ARE ALLOWED TO USE FITTINGS/FRAMES/SUPPORTS AS NEEDED AND THE SAME MUST BE COMMUNICATED BACK TO ENGINEERING TEAM.
10. BOP COMPONENT WEIGHTS ARE FOR REFERENCE ONLY AND SUBJECTED TO CHANGE PER PURCHASED COMPONENTS.

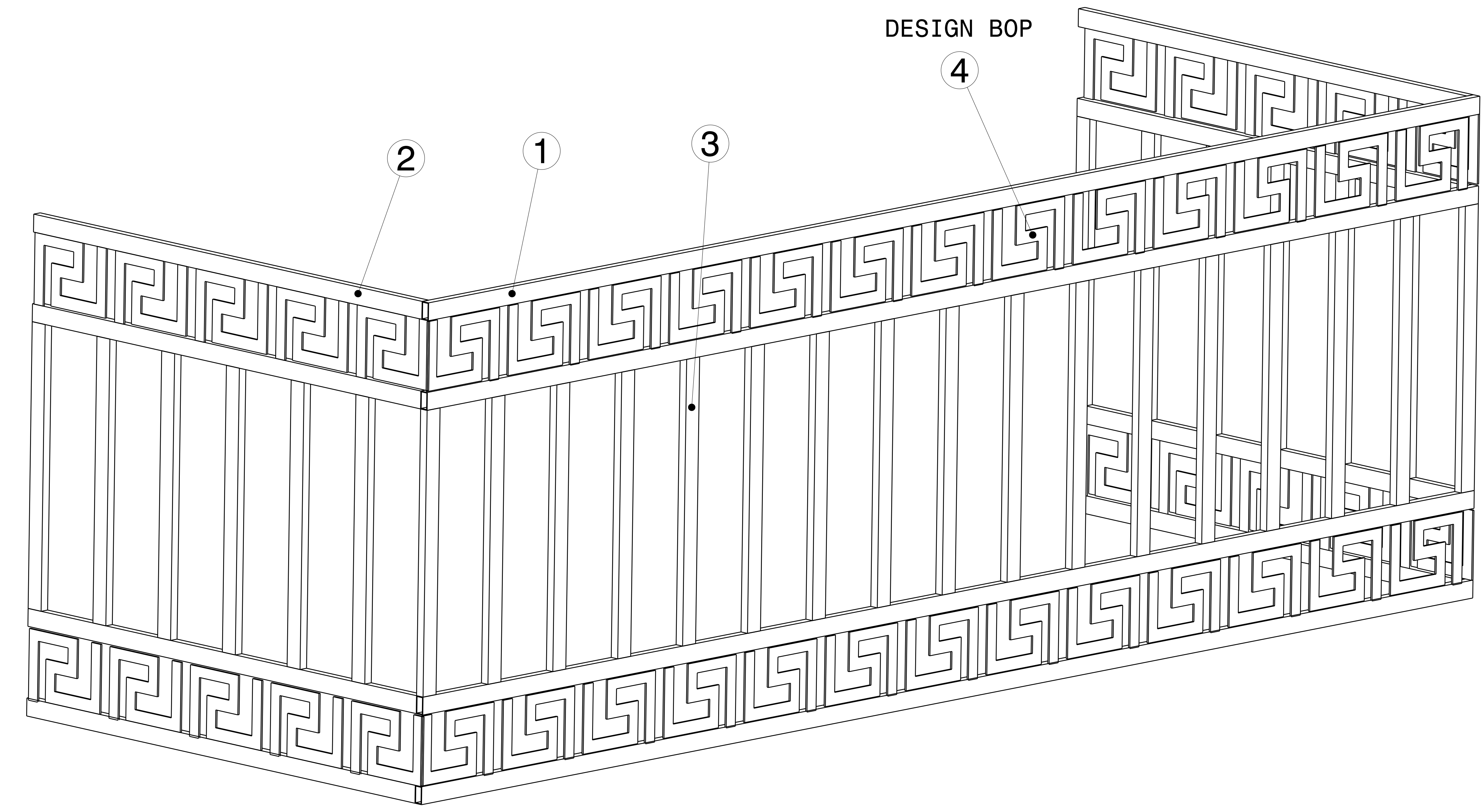

Isometric view
Scale: 3:20

ITEM NO.	PART NUMBER	DESCRIPTION	QTY.	Wt (Kg) /Each
3	RHS FRAME 3	50 X 25 X 2 X 800	29	1.80
2	RHS FRAME 2	50 X 25 X 2 X 1500	8	3.35
1	RHS FRAME 1	50 X 25 X 2 X 4050	4	9.00

This drawing is our property. It can't be reproduced or communicated without our written agreement. www.p2p.ind.in		APL APOLLO TUBES LTD.	
DRAWN BY: RR CHECKED BY: P2P Analysis & Solutions DESIGNED BY: P2P Analysis & Solutions		DRAWING TITLE: PARAPET	
DATE: 20MAY2021		SIZE: A0	
DATE: 20MAY2021		DRAWING NUMBER: P2P MAY 21-22	
DATE: 20MAY2021		SCALE: As Indicated	
		WEIGHT(kg) xxxx	
		SHEET 1 OF 3	

UNLESS OTHERWISE SPECIFIED DIMENSION ARE IN MM
 VIEWS: THIRD ANGLE PROJECTION

REV	DATE	DESCRIPTION
00	20MAY2021	INITIAL REVISION

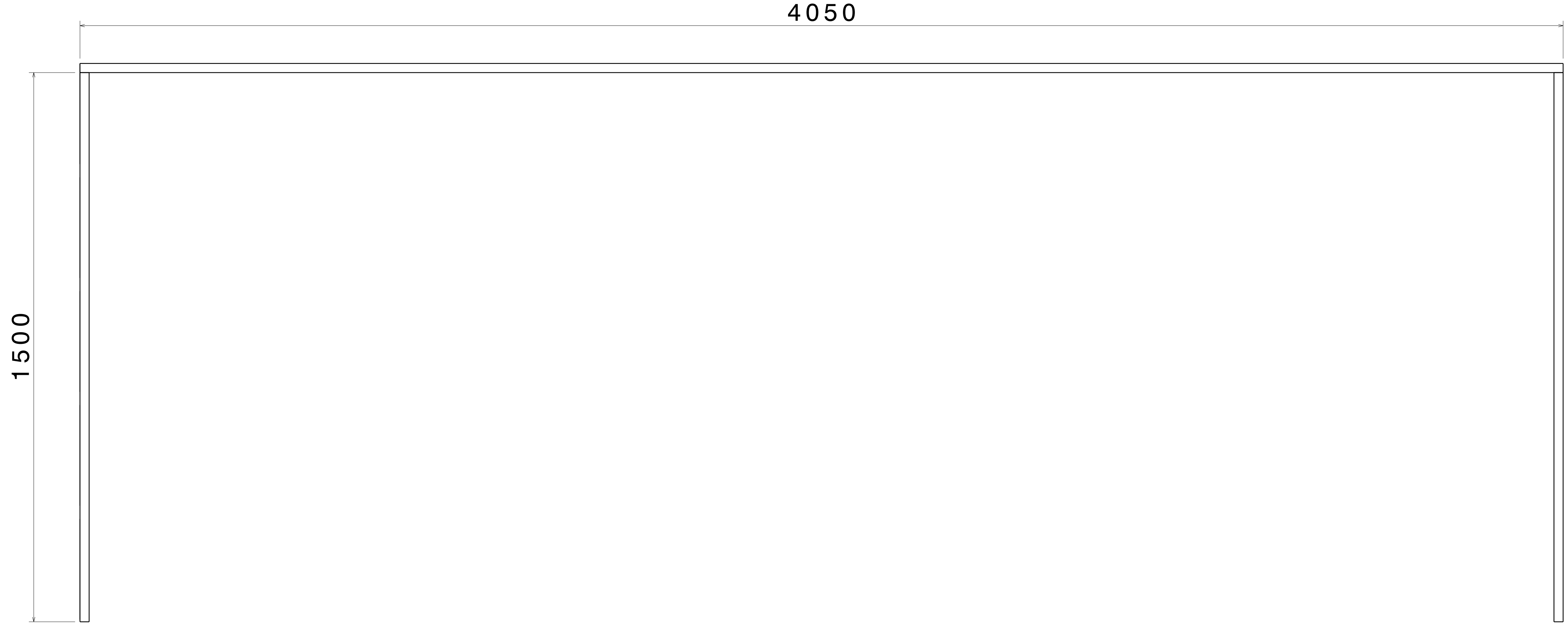

Top view
Scale: 3:20

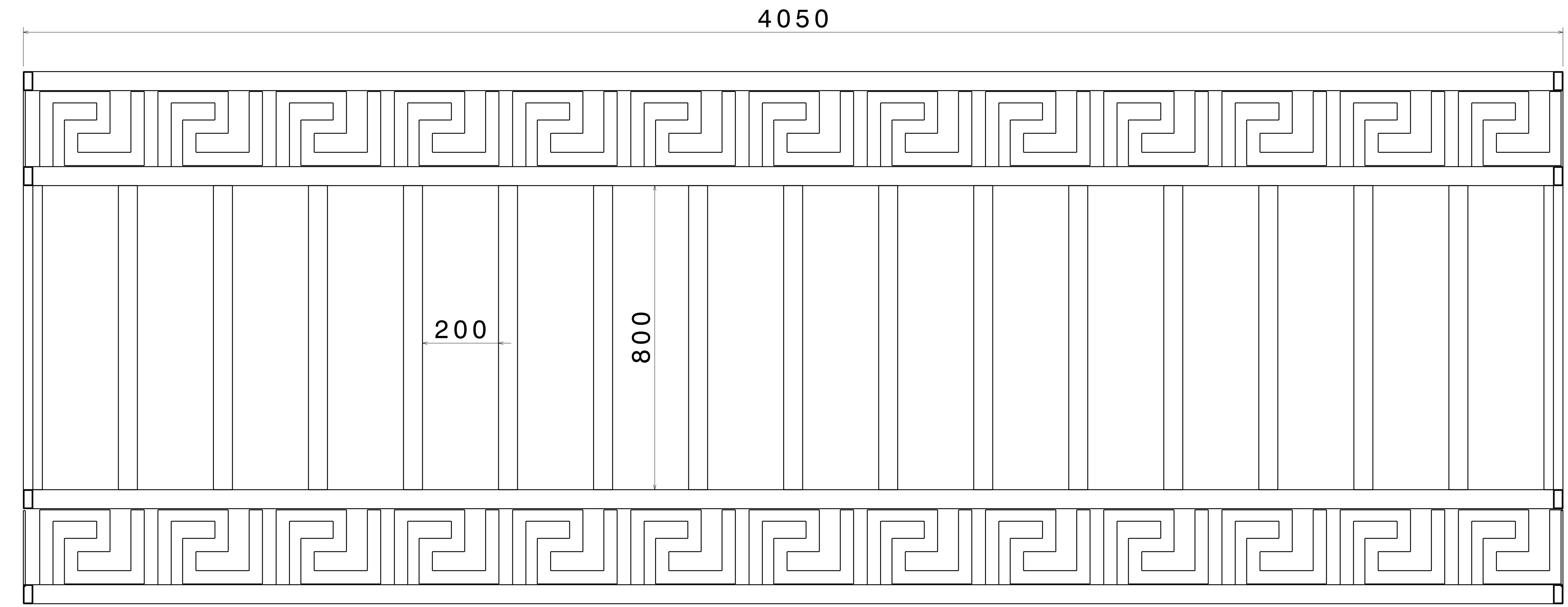

Front view
Scale: 3:20

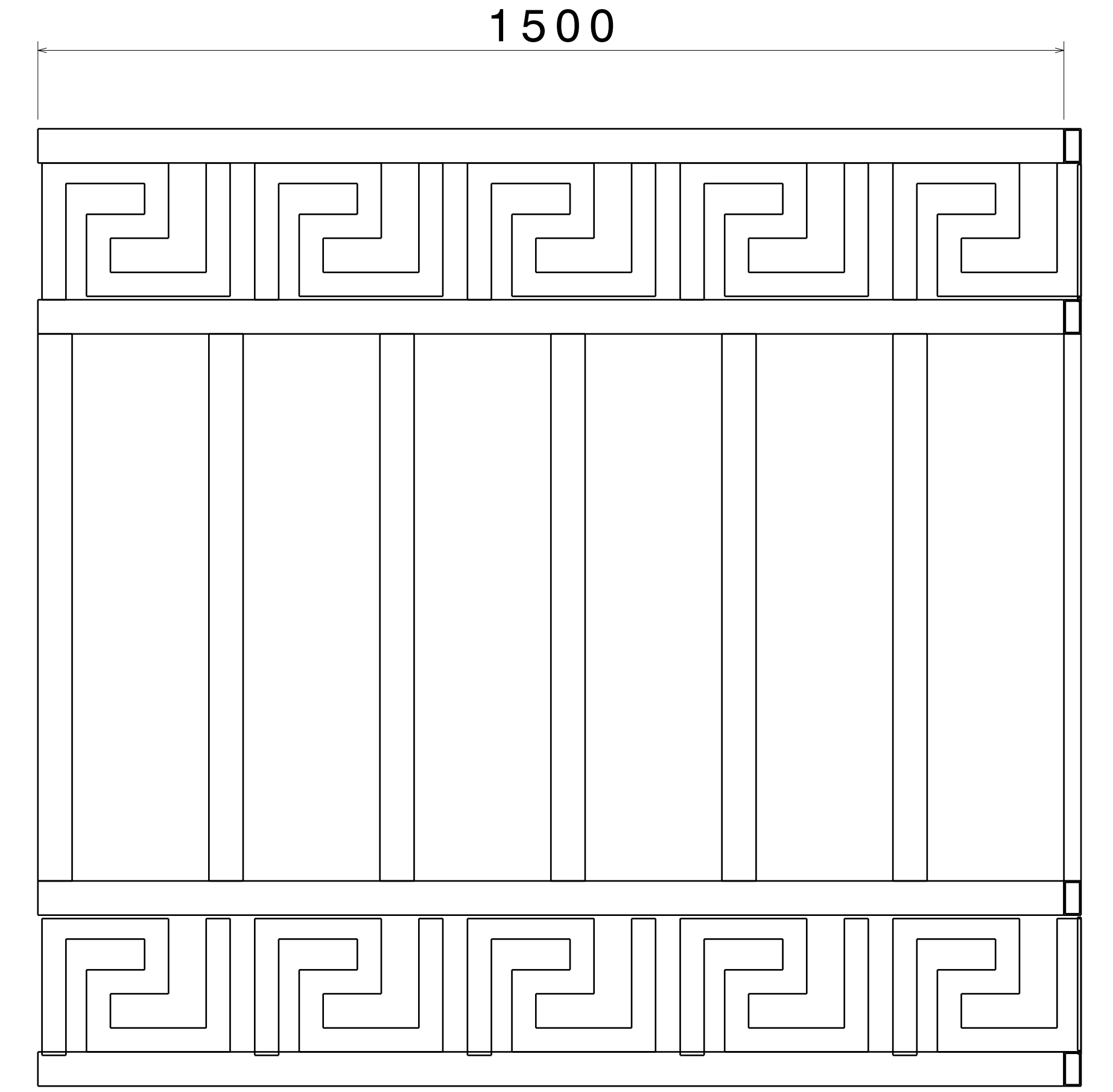

Right view
Scale: 3:20

UNLESS OTHERWISE SPECIFIED DIMENSION ARE IN MM
VIEWS: THIRD ANGLE PROJECTION

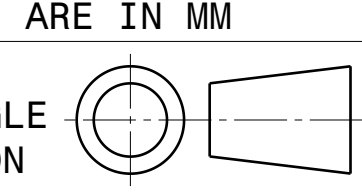

This drawing is our property. It can't be reproduced or communicated without our written agreement.
www.p2p.ind.in
DRAWN BY SB
CHECKED BY P2P Analysis & Solutions
DESIGNED BY P2P Analysis & Solutions

DATE 20MAY2021
DATE 20MAY2021
DATE 20MAY2021

APL APOLLO TUBES LTD. 	
DRAWING TITLE PARAPET	
SIZE A0	DRAWING NUMBER P2P MAY 21-22
SCALE NONE	WEIGHT (kg) XXX
REV 00	SHEET 2 OF 3

REV	DATE	DESCRIPTION
00	20MAY2021	INITIAL REVISION

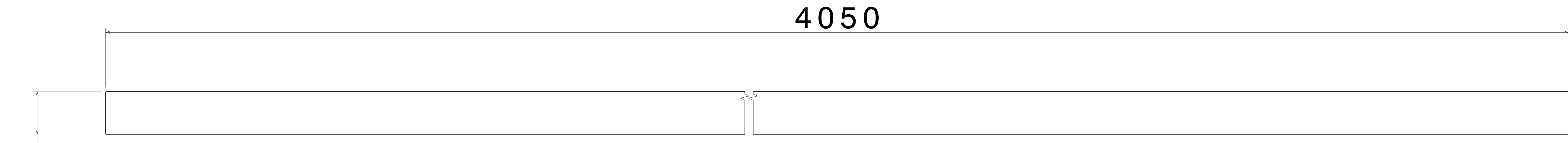

ITEM 1

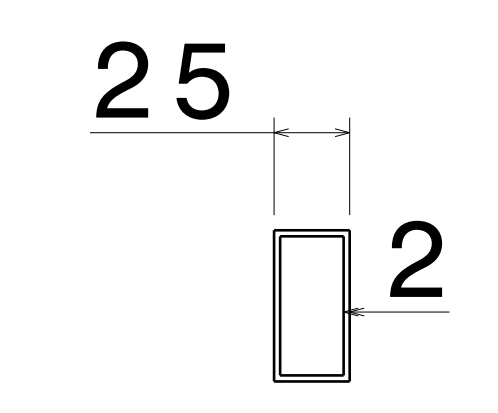

Right view
Scale: 2:5

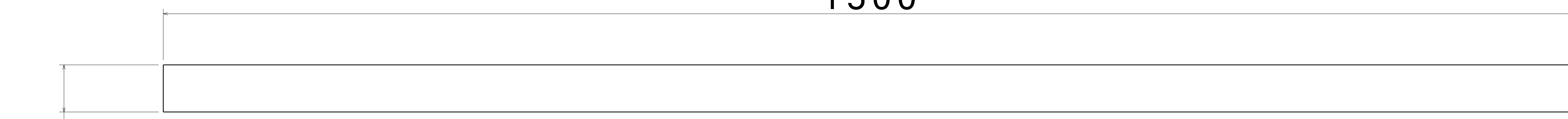

ITEM 2

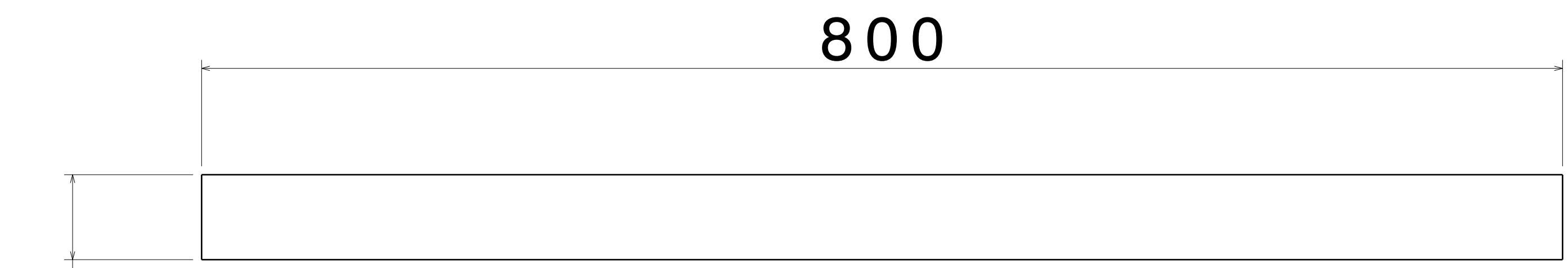

ITEM 3

UNLESS OTHERWISE SPECIFIED DIMENSION ARE IN MM
VIEWS: THIRD ANGLE PROJECTION

This drawing is our property. It can't be reproduced or communicated without our written agreement.
www.p2p.ind.in

DRAWN BY	DATE
SB	20MAY2021
CHECKED BY	DATE
P2P Analysis & Solutions	20MAY2021
DESIGNED BY	DATE
P2P Analysis & Solutions	20MAY2021

APL APOLLO TUBES LTD.	
DRAWING TITLE	
PARAPET	
SIZE	DRAWING NUMBER
A0	P2P MAY 21-22
SCALE	WEIGHT (kg)
NONE	XXX
REV	SHEET 3 OF 3
00	