

REV/DATE	DESCRIPTION
00 / 22MAY2021	INITIAL REVISION

- NOTES:
- (⊥) ALL VERTICAL SUPPORTS ARE PERPENDICULAR.
  - FLATNESS OF .5MM IS APPLIED BY DEFAULT.
  - ⊲ WELD BEAD OF 2MM RADIUS IS FOLLOWED.
  - ▽▽ SURFACE FINISH MEDIUM TO SMOOTH IS USED.
  - ALL TUBES ARE AS PER APL APOLLO STANDARD. CHANGES MAY EFFECT THE LOAD CAPACITY.
  - ALL HORIZONTAL AND VERTICAL TUBES ARE PERPENDICULAR TO EACH OTHER WITH ±1 DEG.
  - FINE WELDING IS REQUIRED AS PER MENTIONED DETAILS AND FINISHING.
  - HIGHER CURRENT WELDING MAY AFFECT THE BRITTLENESS OF MATERIAL WHICH LATER MAY RAISE TO WEAKENING OF STRUCTURE.
  - FABRICATORS ARE ALLOWED TO USE FITTINGS/FRAMES/SUPPORTS AS NEEDED AND THE SAME MUST BE COMMUNICATED BACK TO ENGINEERING TEAM.
  - BOP COMPONENT WEIGHTS ARE FOR REFERENCE ONLY AND SUBJECTED TO CHANGE PER PURCHASED COMPONENTS.

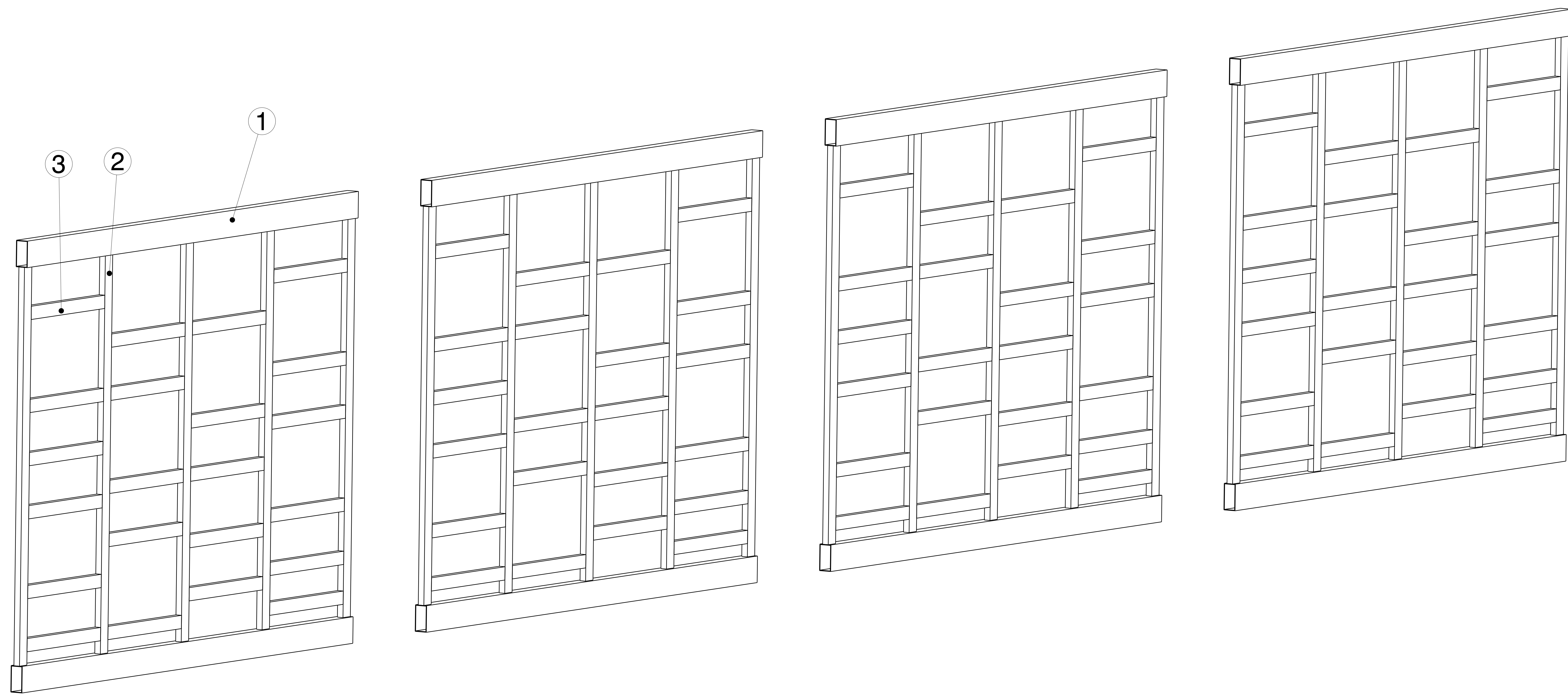

Isometric view  
Scale: 3:20

ITEM NO.	PART NUMBER	DESCRIPTION	QTY.	Wt (Kg)/Each
3	RHS FRAME 3	50 X 25 X 2 X 500	110	1.10
2	RHS FRAME 2	50 X 25 X 2 X 1500	20	3.35
1	RHS FRAME 1	100 X 50 X 2 X 2250	8	10.35

  

UNLESS OTHERWISE SPECIFIED DIMENSION ARE IN MM VIEWS: THIRD ANGLE PROJECTION			This drawing is our property. It can't be reproduced or communicated without our written agreement. www.p2p.ind.in	<b>APL APOLLO TUBES LTD.</b>
DRAWN BY <b>RR</b>	DATE 22MAY2021	DRAWING TITLE <b>BOUNDARY WALL</b>		
CHECKED BY P2P Analysis & Solutions	DATE 22MAY2021	SIZE <b>A0</b>	DRAWING NUMBER <b>P2P MAY 21-23</b>	REV <b>00</b>
DESIGNED BY P2P Analysis & Solutions	DATE 22MAY2021	SCALE As Indicated	WEIGHT(kg) xxxx	SHEET 1 OF 3

REV	DATE	DESCRIPTION
00	22MAY2021	INITIAL REVISION

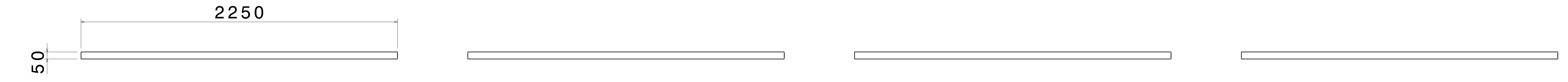

Top view  
Scale: 2:25

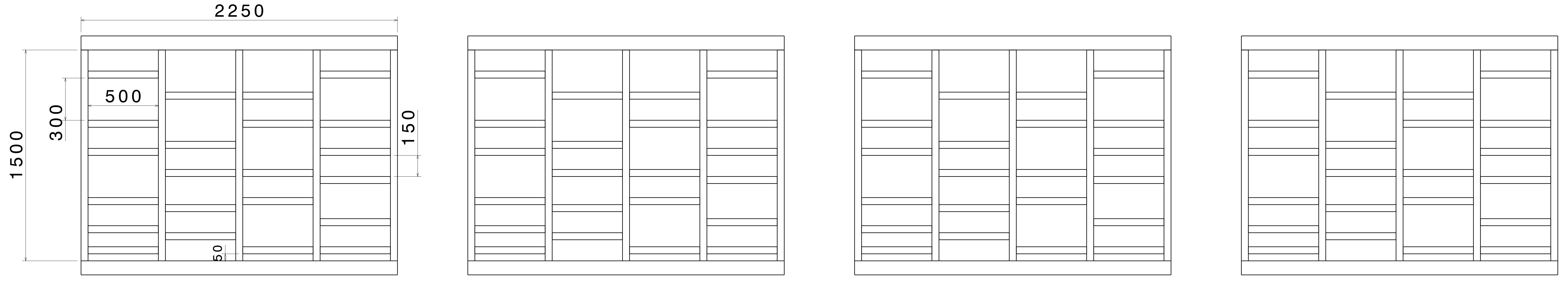

Front view  
Scale: 2:25

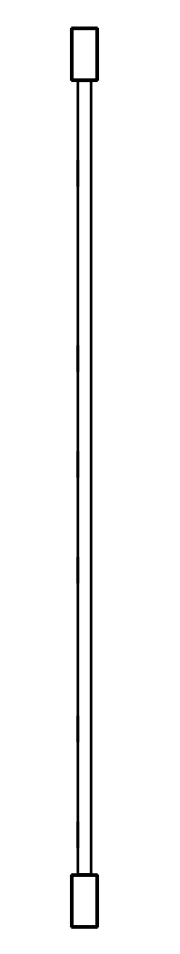

Right view  
Scale: 7:100

UNLESS OTHERWISE SPECIFIED DIMENSION ARE IN MM  
VIEWS: THIRD ANGLE PROJECTION

This drawing is our property. It can't be reproduced or communicated without our written agreement.  
www.p2p.ind.in

DRAWN BY: SB  
CHECKED BY: P2P Analysis & Solutions  
DESIGNED BY: P2P Analysis & Solutions

DATE: 22MAY2021  
DATE: 22MAY2021  
DATE: 22MAY2021

APL APOLLO TUBES LTD.	
DRAWING TITLE: BOUNDARY WALL	
SIZE: A0	DRAWING NUMBER: P2P MAY 21-23
SCALE: NONE	WEIGHT (kg): XXX
REV: 00	SHEET 2 OF 3

REV	DATE	DESCRIPTION
00	22MAY2021	INITIAL REVISION

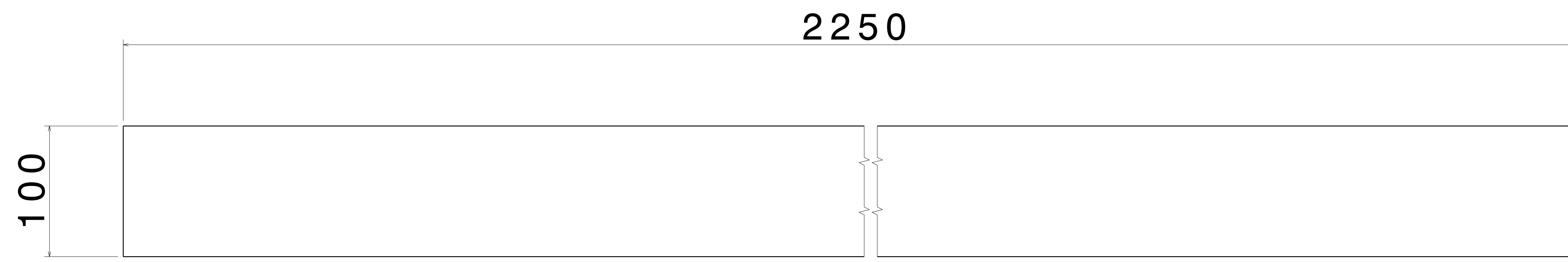

ITEM 1

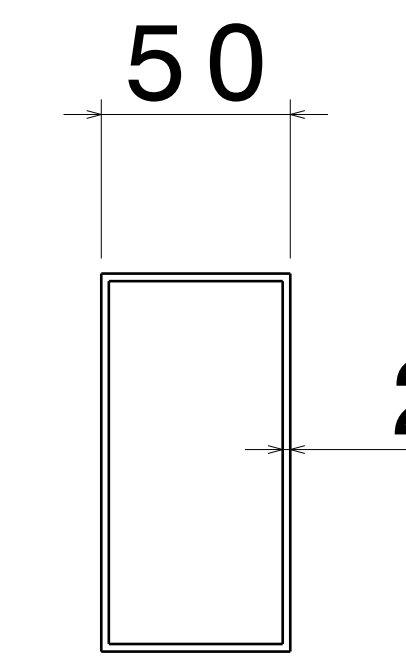

Right view  
Scale: 1:2

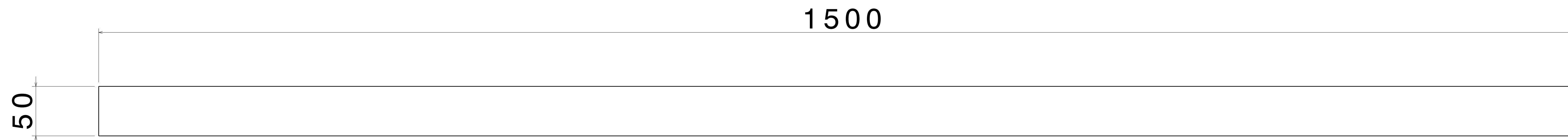

ITEM 2

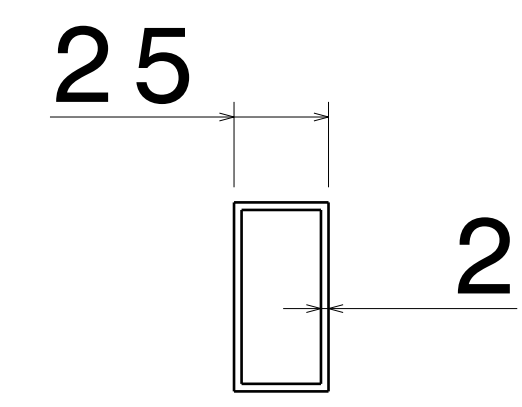

Right view  
Scale: 1:2

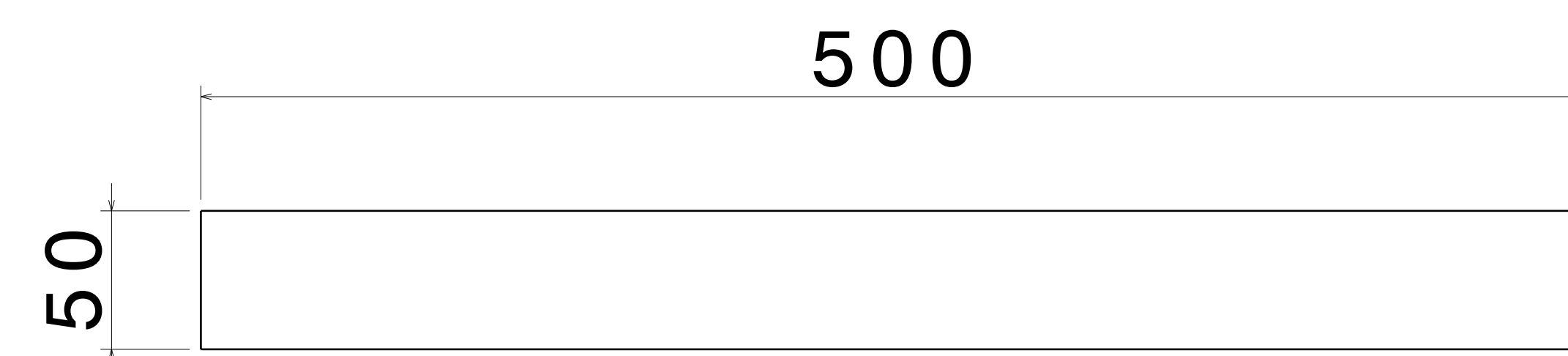

ITEM 3

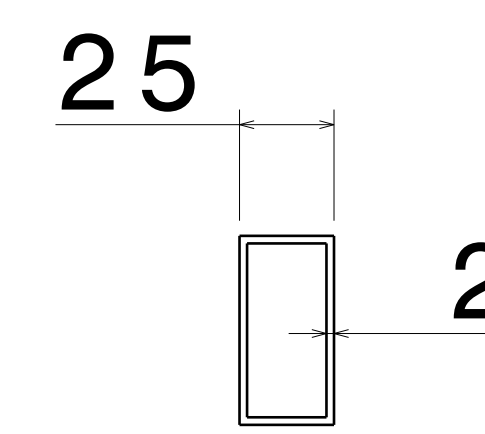

Right view  
Scale: 1:2

UNLESS OTHERWISE SPECIFIED DIMENSION ARE IN MM  
VIEWS: THIRD ANGLE PROJECTION

This drawing is our property. It can't be reproduced or communicated without our written agreement.  
www.p2p.ind.in

DRAWN BY	DATE
SB	22MAY2021
CHECKED BY	DATE
P2P Analysis & Solutions	22MAY2021
DESIGNED BY	DATE
P2P Analysis & Solutions	22MAY2021

APL APOLLO TUBES LTD.			
DRAWING TITLE			
BOUNDARY WALL			
SIZE	DRAWING NUMBER	REV	
A0	P2P MAY 21-23	00	
SCALE	NONE	WEIGHT (kg)	XXX
			SHEET 3 OF 3