

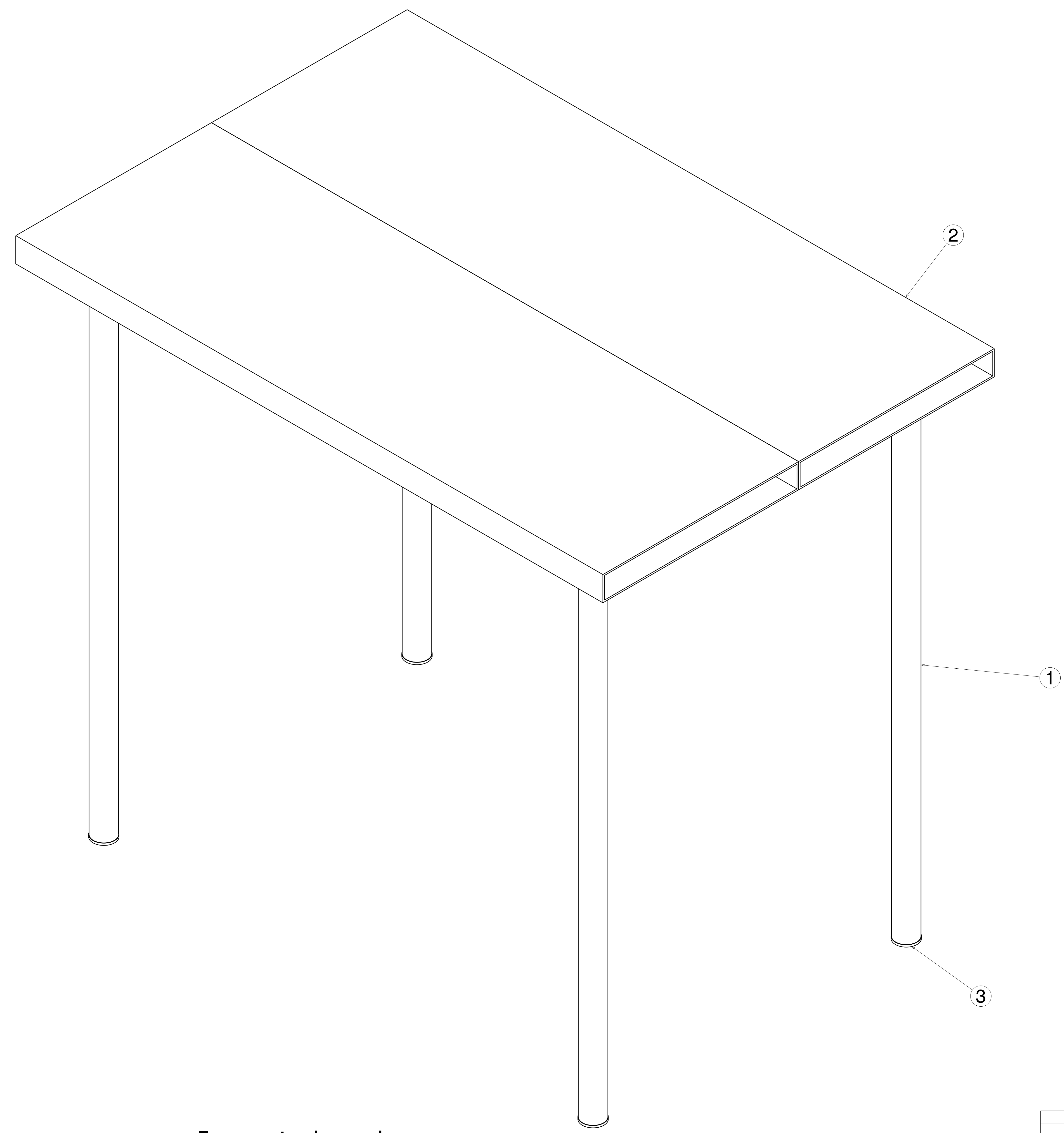

REV	DATE	DESCRIPTION
00	24NOV2020	INITIAL REVISION

- NOTES:
1. (⊥) ALL VERTICAL SUPPORTS ARE PERPENDICULAR.
 2. □ FLATNESS OF .5MM IS APPLIED BY DEFAULT.
 3. ⚡ WELD BEAD OF 2MM RADIUS IS FOLLOWED.
 4. ∇ SURFACE FINISH MEDIUM TO SMOOTH IS USED.
 5. ALL TUBES ARE AS PER APL APOLLO STANDARD. CHANGES MAY EFFECT THE LOAD CAPACITY.
 6. ALL HORIZONTAL AND VERTICAL TUBES ARE PERPENDICULAR TO EACH OTHER WITH ±1 DEG.
 7. FINE WELDNG IS REQUIRED AS PER MENTIONED DETAILS AND FINISHING.
 8. HIGHER CURRENT WELDING MAY AFFECT THE BRITTLENESS OF MATERIAL WHICH LATER MAY RAISE TO WEAKENING OF STRUCTURE.
 9. FABRICATORS ARE ALLOWED TO USE FITTINGS/FRAMES/SUPPORTS AS NEEDED AND THE SAME MUST BE COMMUNICATED BACK TO ENGINEERING TEAM.
 10. BOP COMPONENT WEIGHTS ARE FOR REFERENCE ONLY AND SUBJECTED TO CHANGE PER PURCHASED COMPONENTS.



Isometric view
Scale: 3:4

ITEM NO.	PART NUMBER	DESCRIPTION	QTY.	Wt (kg) /Each
3	PLASTIC INSERT-BOP	---	---	---
2	RHS PLANK 1	200 X 25 X 1.6 X 600	4	3.35
1	ROUND TUBE 1	21.3 X 1.6 X 500	4	0.39

This drawing is our property. It can't be reproduced or communicated without our written agreement.		APL APOLLO TUBES LTD. 	
DRAWN BY		DRAWING TITLE	
SB	24NOV2020	NOV 20 05	
CHECKED BY	DATE	SIZE	DRAWING NUMBER
P2P Analysis & Solutions	24NOV2020	A0	P2P NOV 20 05
DESIGNED BY	DATE	SCALE	REV
P2P Analysis & Solutions	24NOV2020	As Indicated	00
		WEIGHT(kg)	SHEET 1 OF 3
		0kg	

UNLESS OTHERWISE SPECIFIED DIMENSION ARE IN MM
VIEWS: THIRD ANGLE PROJECTION

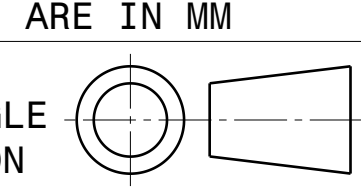

REV	DATE	DESCRIPTION
00	24NOV2020	INITIAL REVISION



Top view
Scale: 1:2

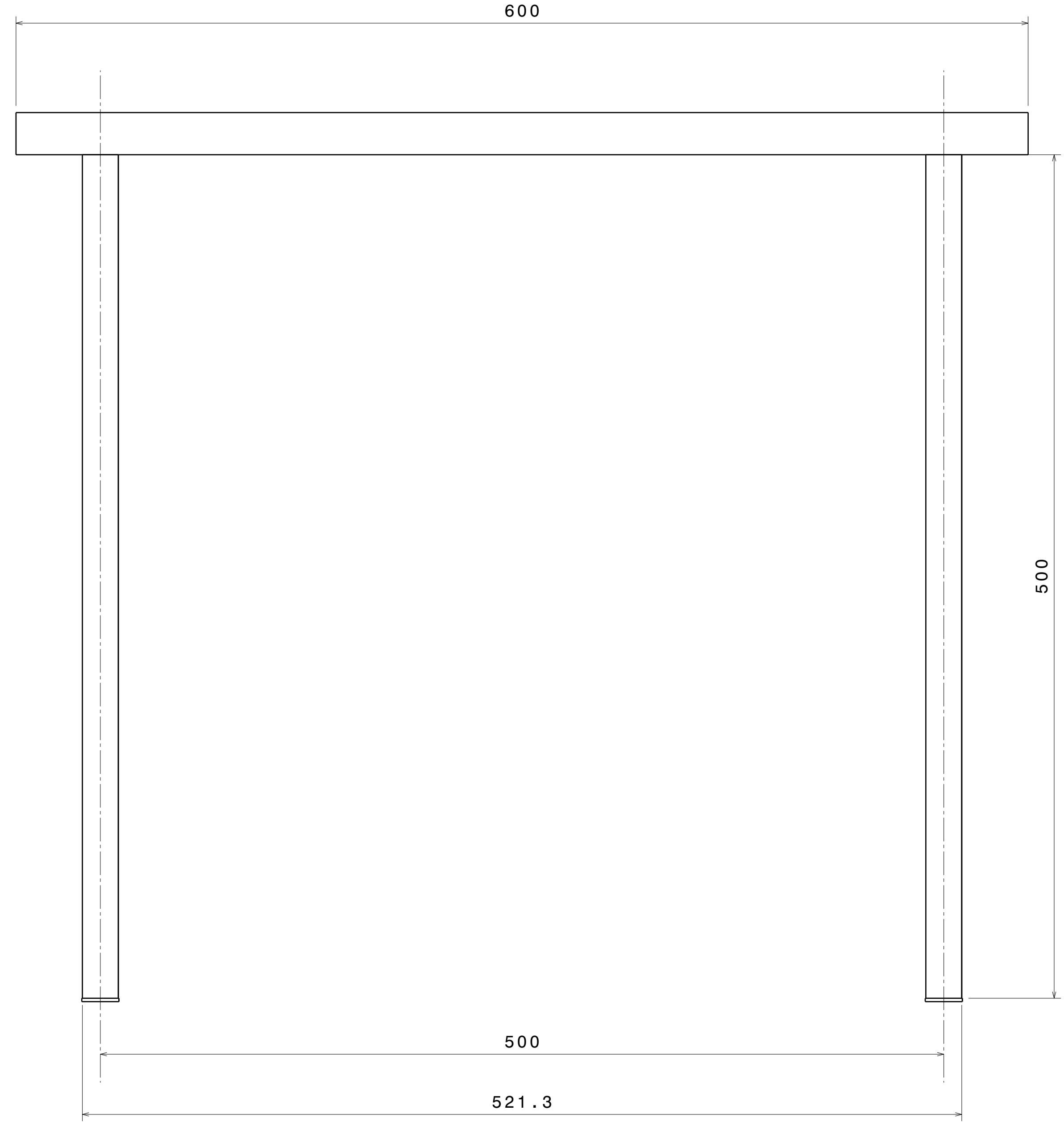

Front view
Scale: 1:2

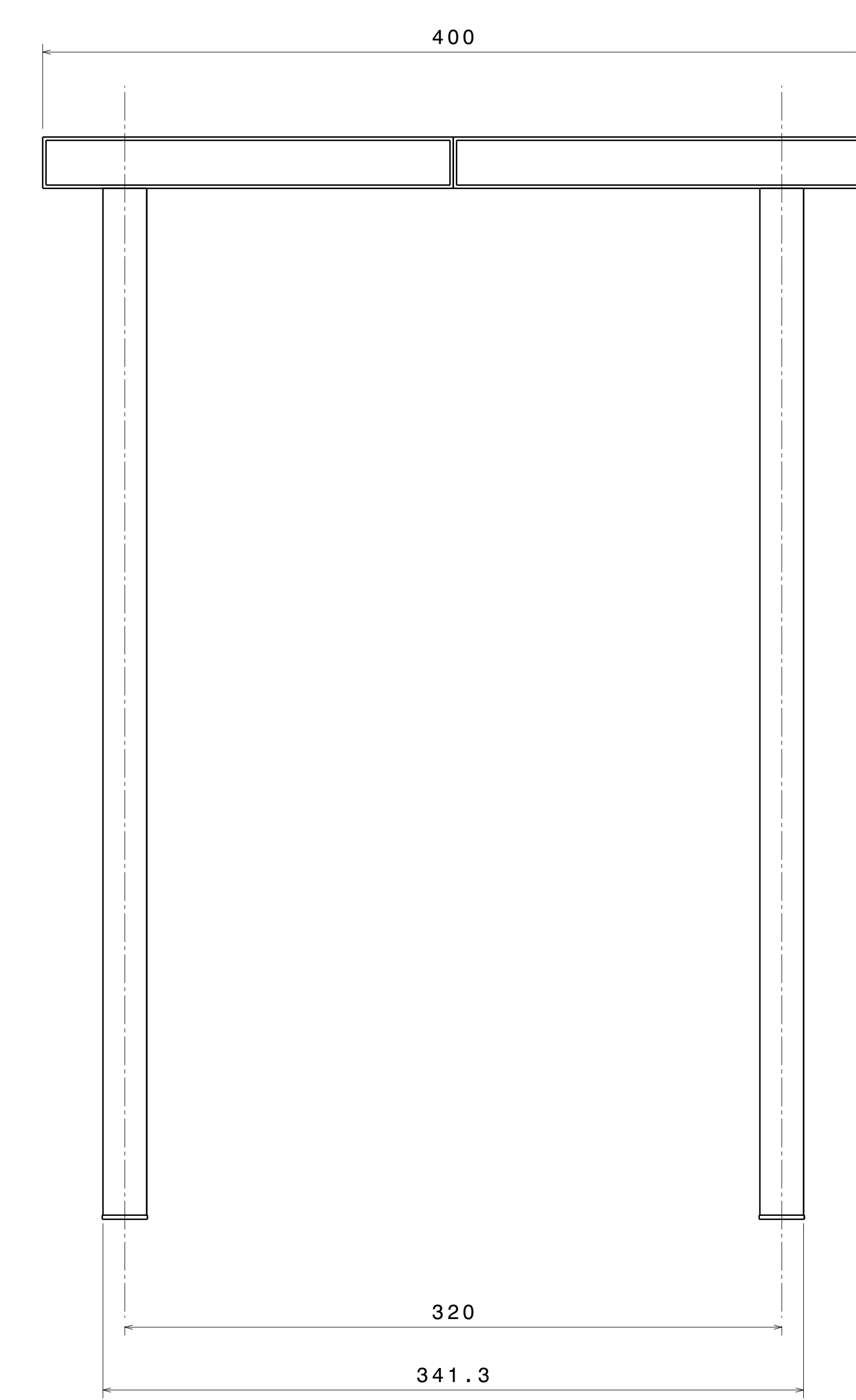

Right view
Scale: 1:2

UNLESS OTHERWISE SPECIFIED DIMENSION ARE IN MM
VIEWS: THIRD ANGLE PROJECTION

This drawing is our property. It can't be reproduced or communicated without our written agreement.

DRAWN BY	DATE
SB	24NOV2020
CHECKED BY	DATE
P2P Analysis & Solutions	24NOV2020
DESIGNED BY	DATE
P2P Analysis & Solutions	24NOV2020

APL APOLLO TUBES LTD.	
DRAWING TITLE	
NOV 20_05	
SIZE	DRAWING NUMBER
A0	P2P NOV 20_05
SCALE	WEIGHT (kg)
NONE	XXX
REV	SHEET 2 OF 3
00	

REV	DATE	DESCRIPTION
00	24NOV2020	INITIAL REVISION

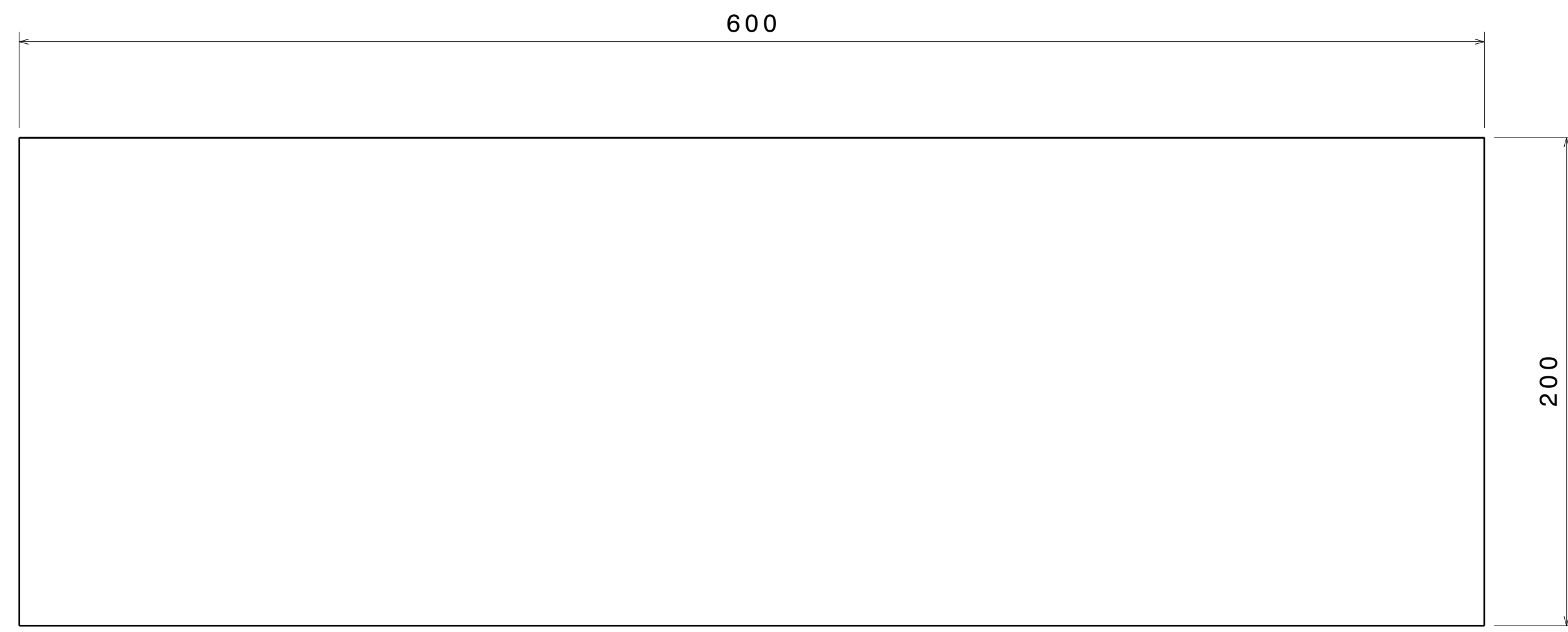

FRONT VIEW[2]
ITEM 2

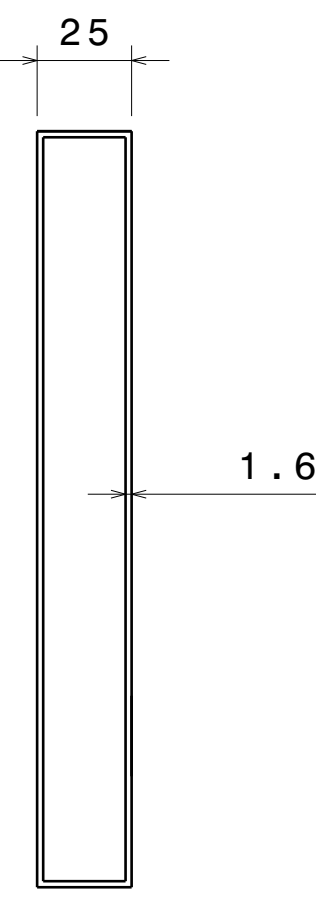

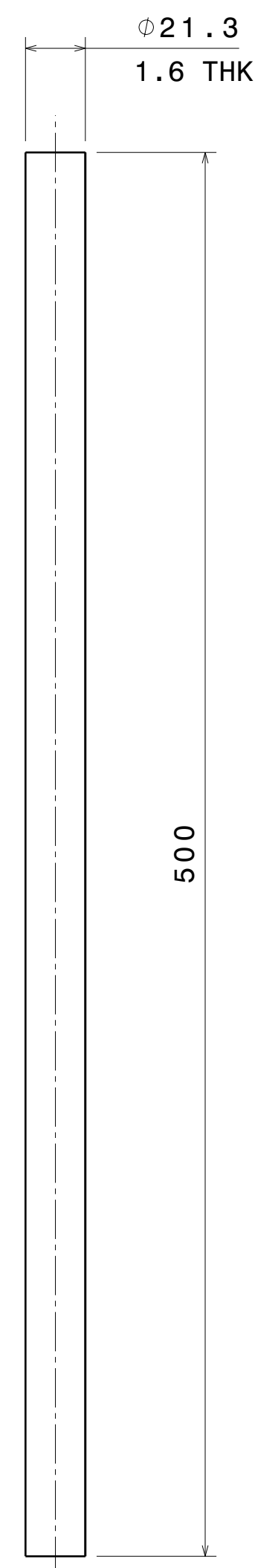

SIDE VIEWA
Scale: 1:2

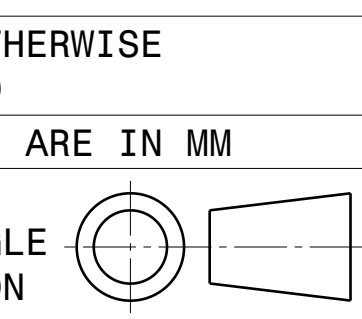

FRONT VIEW, ITEM 1
Scale: 1:2

UNLESS OTHERWISE SPECIFIED DIMENSION ARE IN MM
VIEWS: THIRD ANGLE PROJECTION



This drawing is our property. It can't be reproduced or communicated without our written agreement.		APL APOLLO TUBES LTD. 	
DRAWN BY SB		DATE 24NOV2020	
CHECKED BY P2P Analysis & Solutions		DATE 24NOV2020	
DESIGNED BY P2P Analysis & Solutions		DATE 24NOV2020	
SIZE A0	DRAWING NUMBER NOV 20_05		REV 00
SCALE NONE	WEIGHT (kg)	XXX	SHEET 3 OF 3