

REV	DATE	DESCRIPTION
00	11NOV2020	INITIAL REVISION

- NOTES:
- (⊥) ALL VERTICAL SUPPORTS ARE PERPENDICULAR.
  - FLATNESS OF .5MM IS APPLIED BY DEFAULT.
  - ⊲ WELD BEAD OF 2MM RADIUS IS FOLLOWED.
  - ▽ SURFACE FINISH MEDIUM TO SMOOTH IS USED.
  - ALL TUBES ARE AS PER APL APOLLO STANDARD. CHANGES MAY EFFECT THE LOAD CAPACITY.
  - ALL HORIZONTAL AND VERTICAL TUBES ARE PERPENDICULAR TO EACH OTHER WITH ±1 DEG.
  - FINE WELDING IS REQUIRED AS PER MENTIONED DETAILS AND FINISHING.
  - HIGHER CURRENT WELDING MAY AFFECT THE BRITTLENESS OF MATERIAL WHICH LATER MAY RAISE TO WEAKENING OF STRUCTURE.
  - FABRICATORS ARE ALLOWED TO USE FITTINGS/FRAMES/SUPPORTS AS NEEDED AND THE SAME MUST BE COMMUNICATED BACK TO ENGINEERING TEAM.
  - BOP COMPONENT WEIGHTS ARE FOR REFERENCE ONLY AND SUBJECTED TO CHANGE PER PURCHASED COMPONENTS.

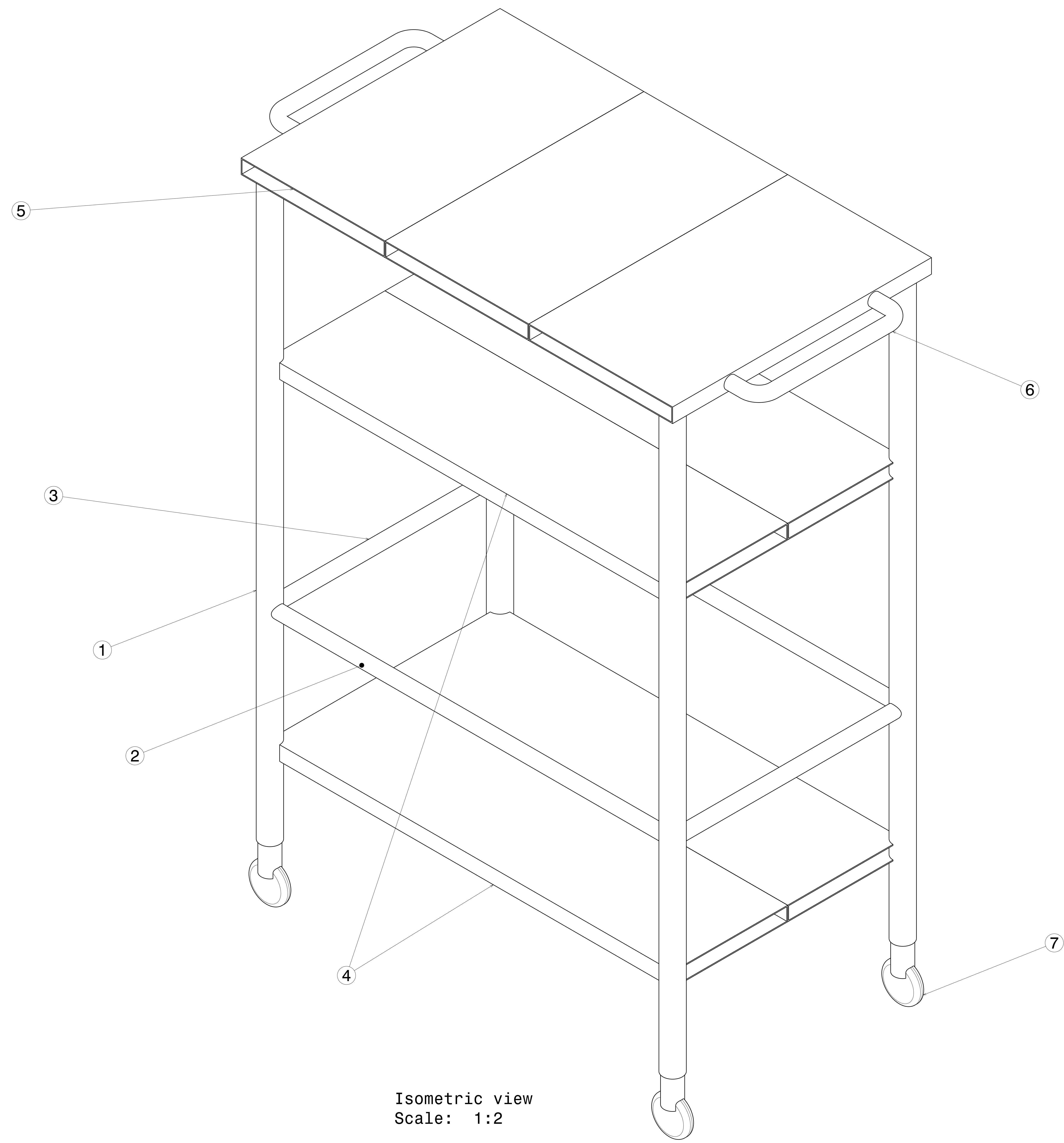

Isometric view  
Scale: 1:2

ITEM NO.	PART NUMBER	DESCRIPTION	QTY.	Wt (Kg)/Each
7	WHEEL - BOP	----	----	----
6	HANDLE ROUND TUBE	DIA 21.3 X 1.6 X 450	2	0.3
5	RHS PLANK 2	250 X 25 X 1.6 X 450	3	3.1
4	RHS PLANK 1	200 X 25 X 1.6 X 700	4	3.9
3	ROUND TUBE 3	DIA 21.3 X 1.6 X 400	2	0.29
2	ROUND TUBE 2	DIA 21.3 X 1.6 X 700	2	0.52
1	ROUND TUBE 1	DIA 33.7 X 2 X 1000	4	1.57

ITEM NO. PART NUMBER DESCRIPTION QTY. Wt (Kg)/Each  
 This drawing is our property. It can't be reproduced or communicated without our written agreement.

**APL APOLLO TUBES LTD.**

DRAWING TITLE: NOV 20 11

SIZE: A0 DRAWING NUMBER: P2P NOV 20 11 REV: 00

SCALE: As Indicated WEIGHT (kg): 0kg SHEET 1 OF 3

UNLESS OTHERWISE SPECIFIED DIMENSION ARE IN MM  
 VIEWS: THIRD ANGLE PROJECTION

REV	DATE	DESCRIPTION
00	11NOV2020	INITIAL REVISION

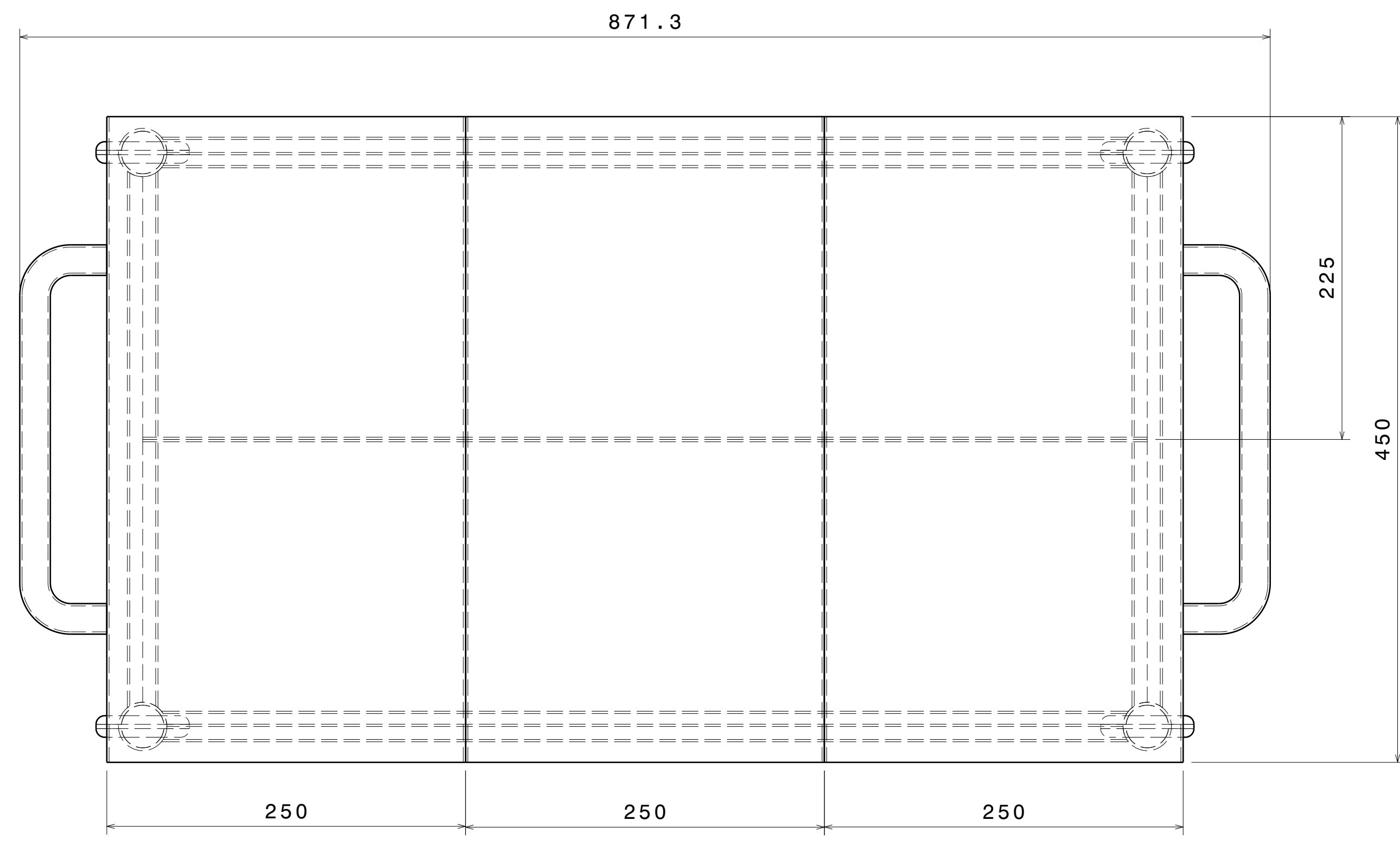

Top view  
Scale: 7:20

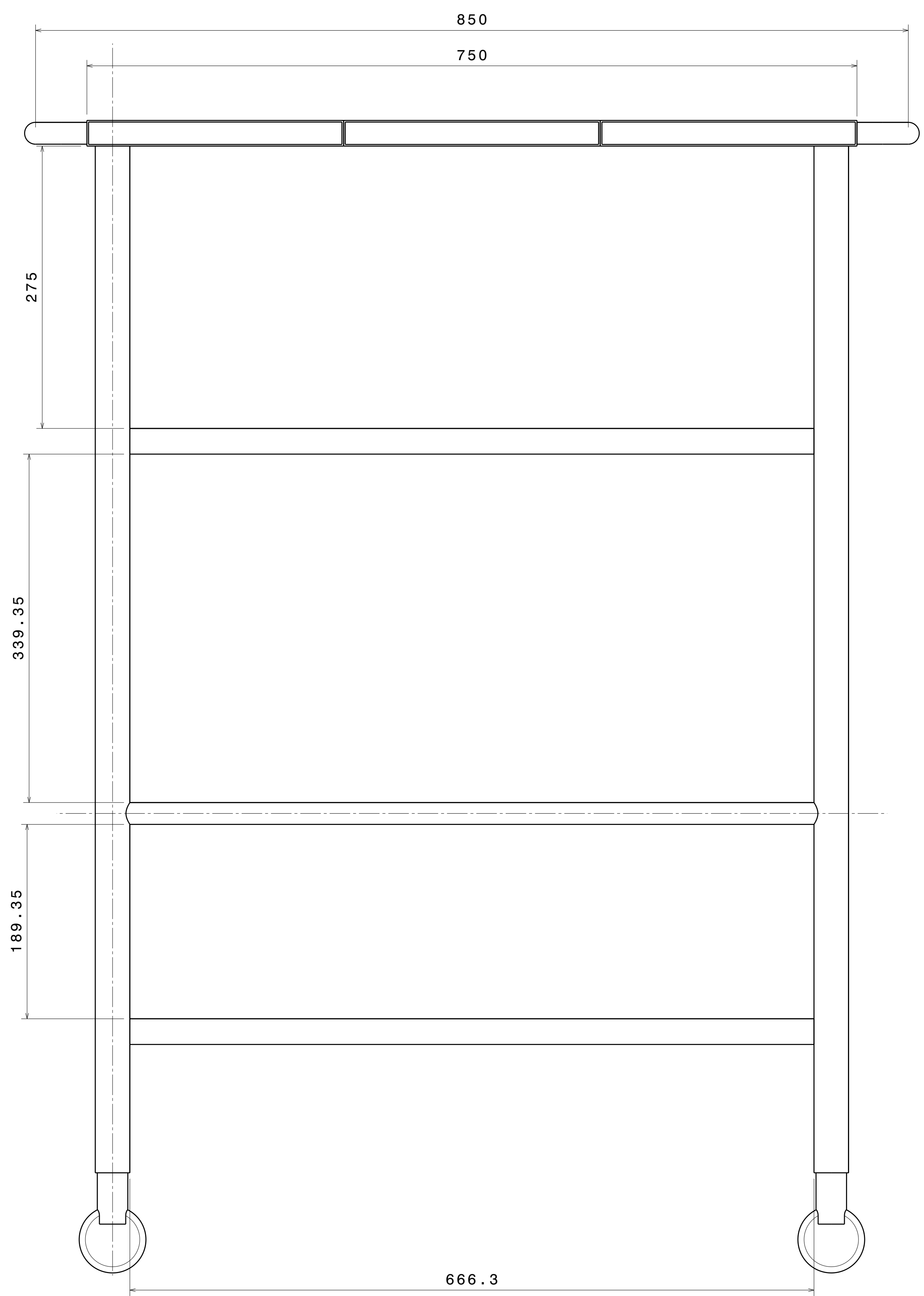

Front view  
Scale: 7:20

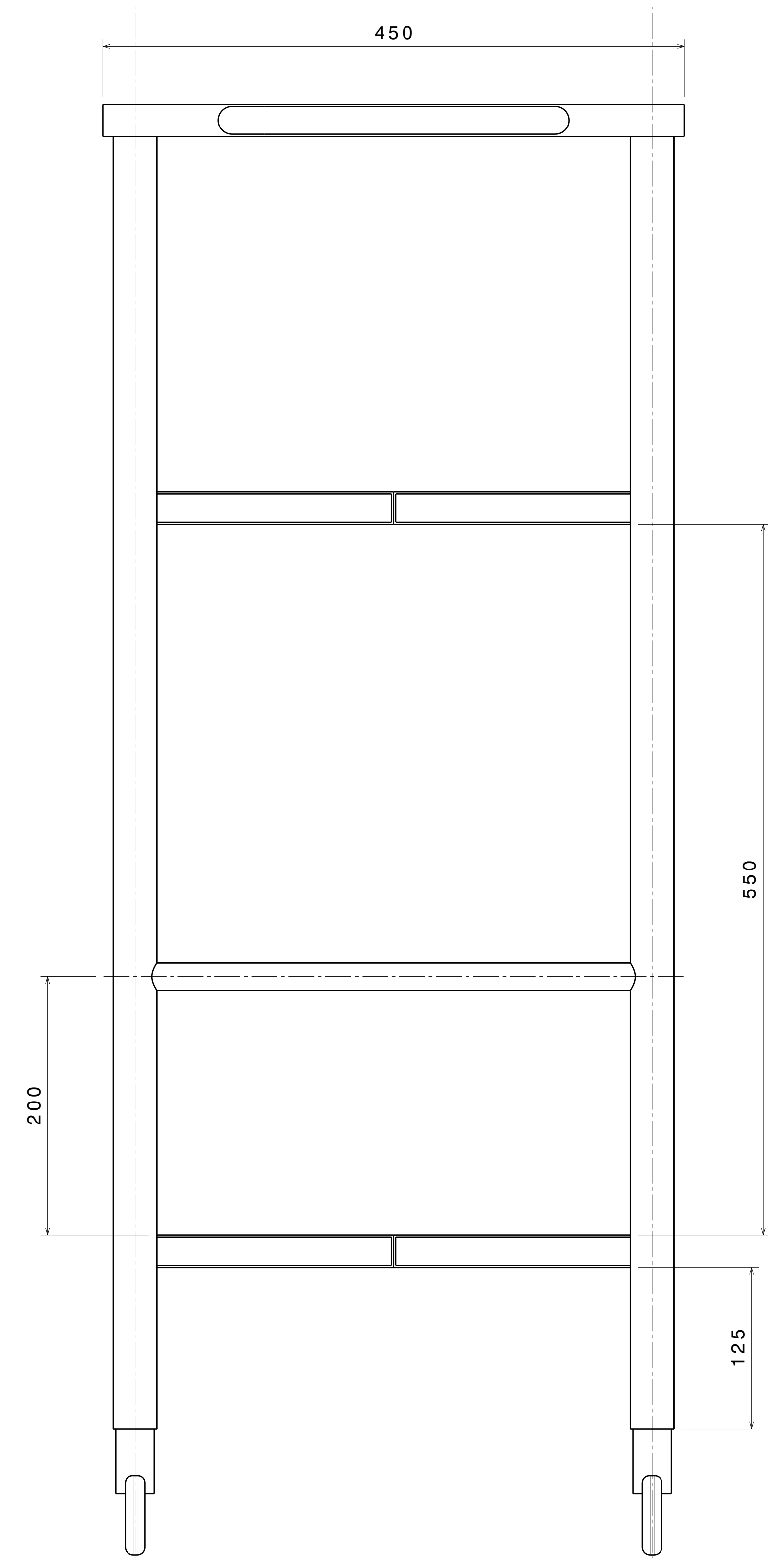

Right view  
Scale: 7:20

UNLESS OTHERWISE SPECIFIED DIMENSION ARE IN MM  
VIEWS: THIRD ANGLE PROJECTION

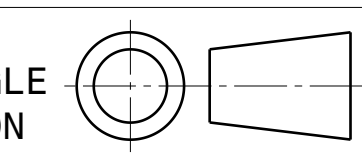

This drawing is our property. It can't be reproduced or communicated without our written agreement.

APL APOLLO TUBES LTD. 

DRAWN BY	DATE	DRAWING TITLE	
SB	11NOV2020	NOV 20_11	
CHECKED BY	DATE	SIZE	DRAWING NUMBER
P2P Analysis & Solutions	11NOV2020	A0	P2P NOV 20_11
DESIGNED BY	DATE	SCALE	WEIGHT (kg)
P2P Analysis & Solutions	11NOV2020	NONE	XXX
		SHEET 2 OF 3	

REV  
00

REV	DATE	DESCRIPTION
00	11NOV2020	INITIAL REVISION

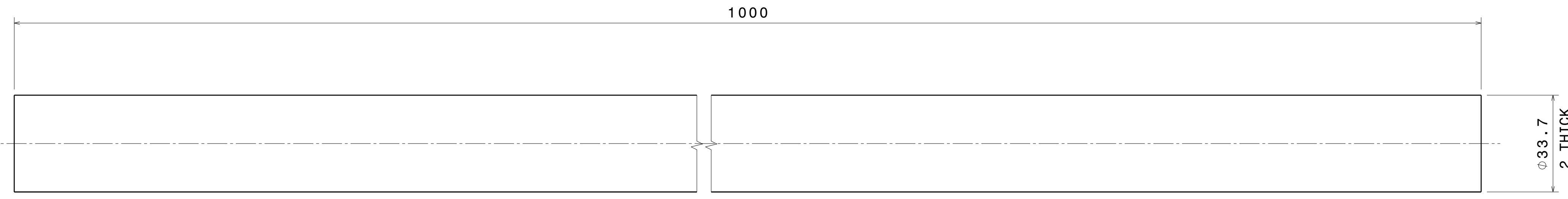

ITEM 1

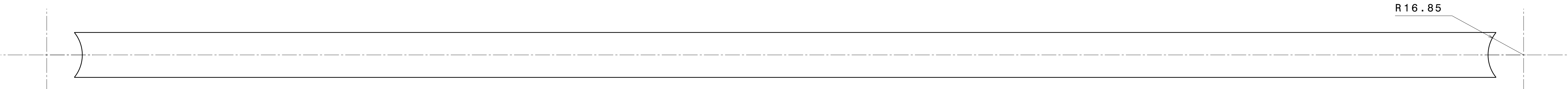

Top view  
ITEM 2

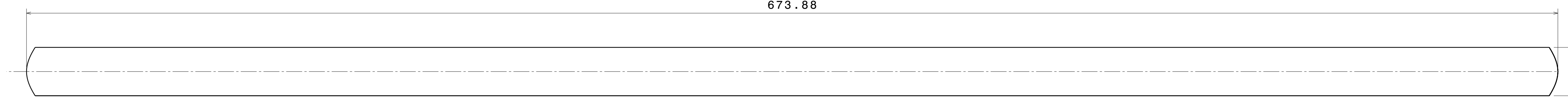

ITEM 2

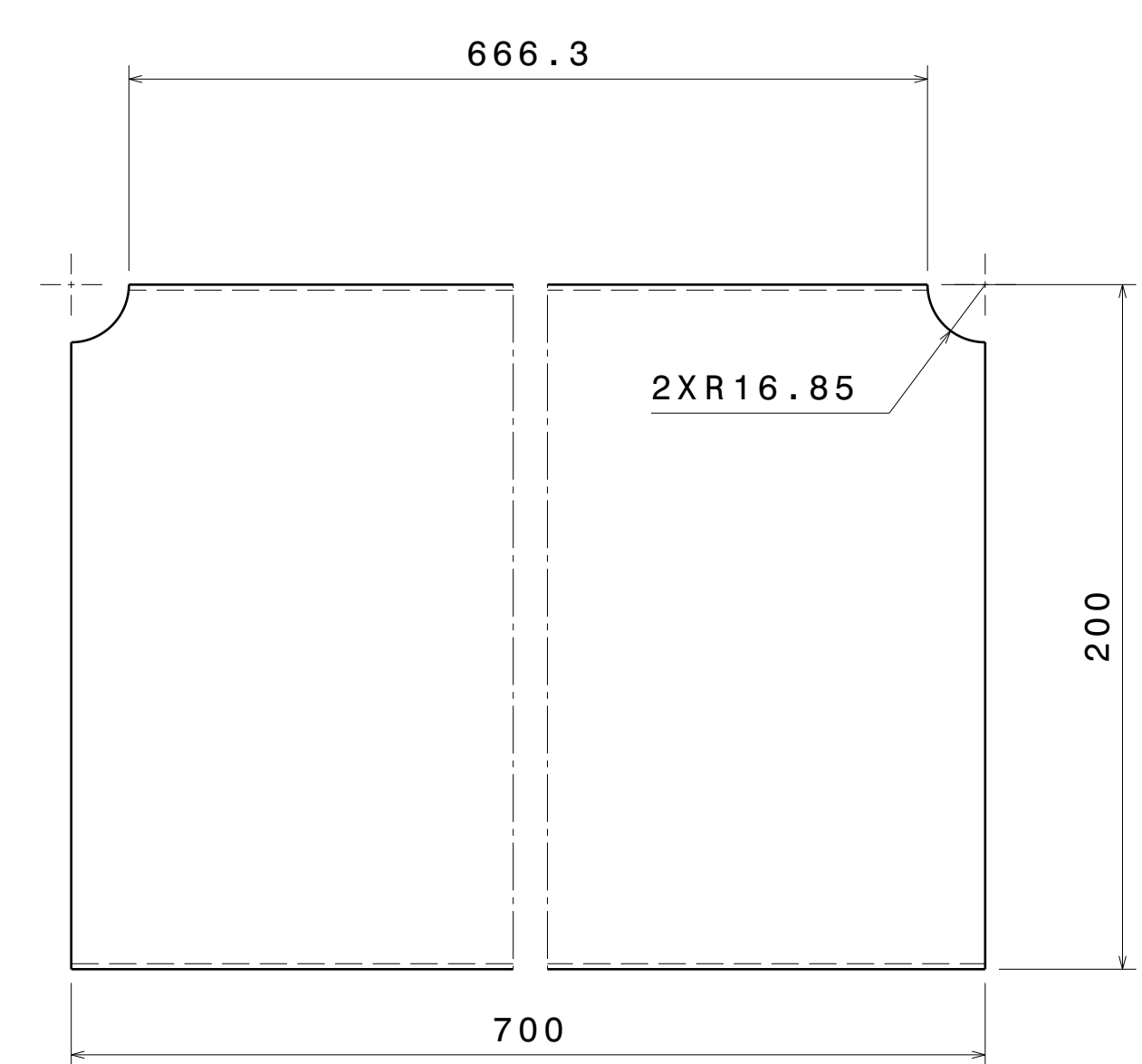

ITEM 4

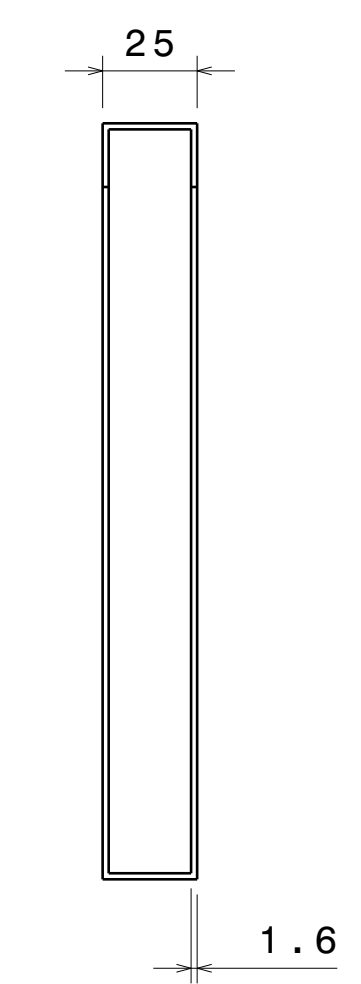

Right view  
Scale: 1:2

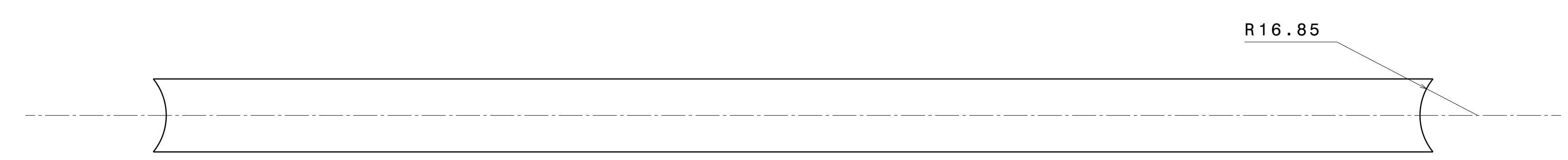

Top view  
ITEM 3

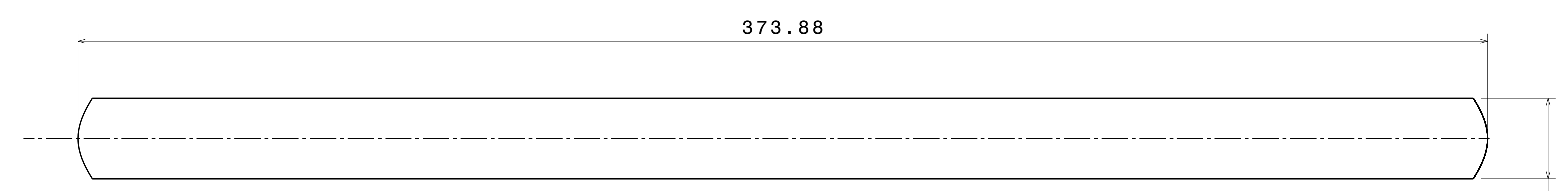

ITEM 3

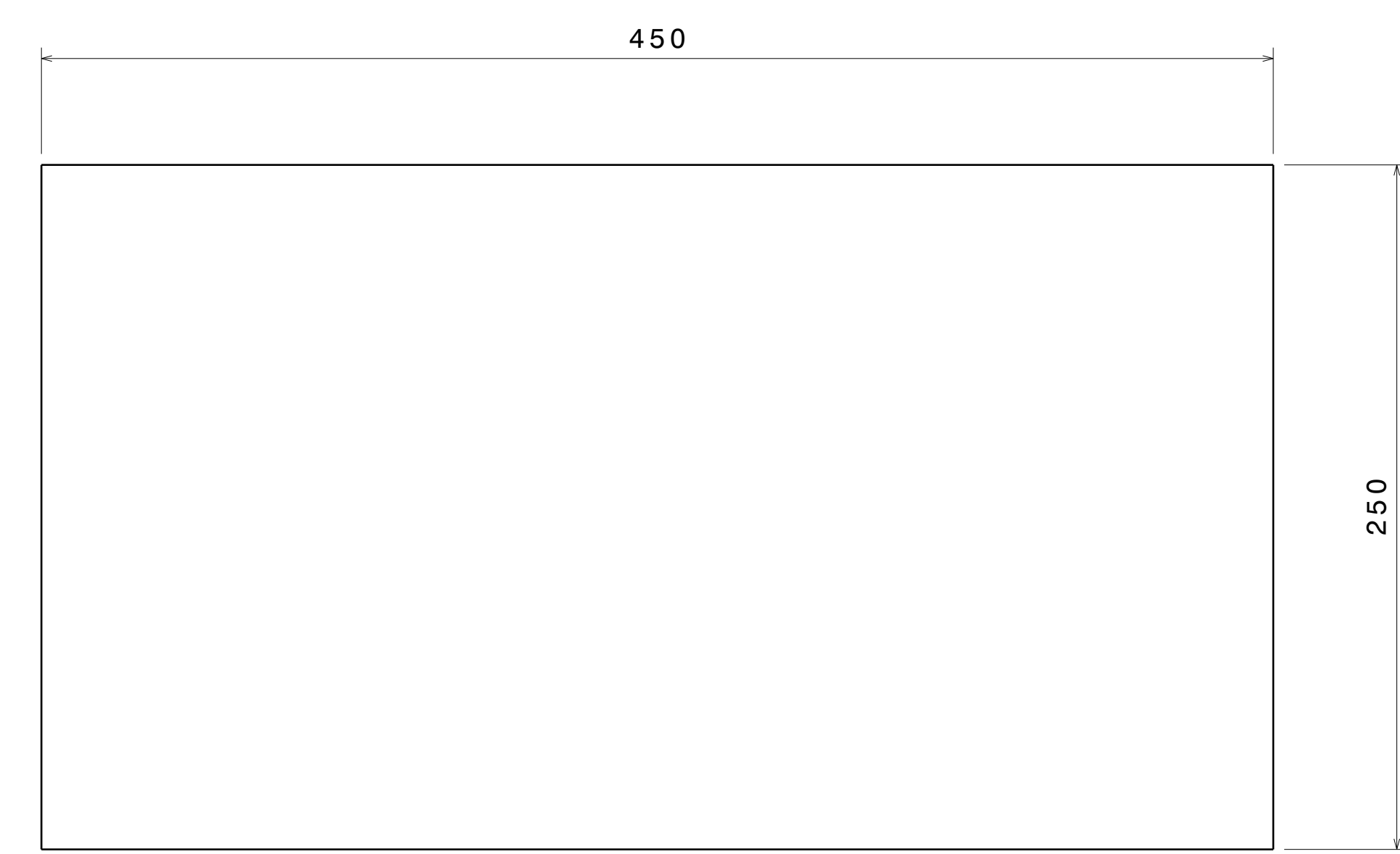

ITEM 5

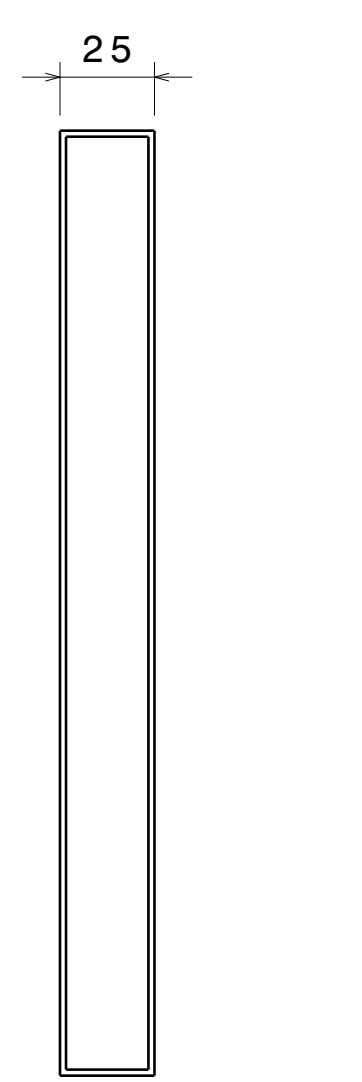

Right view  
Scale: 1:2

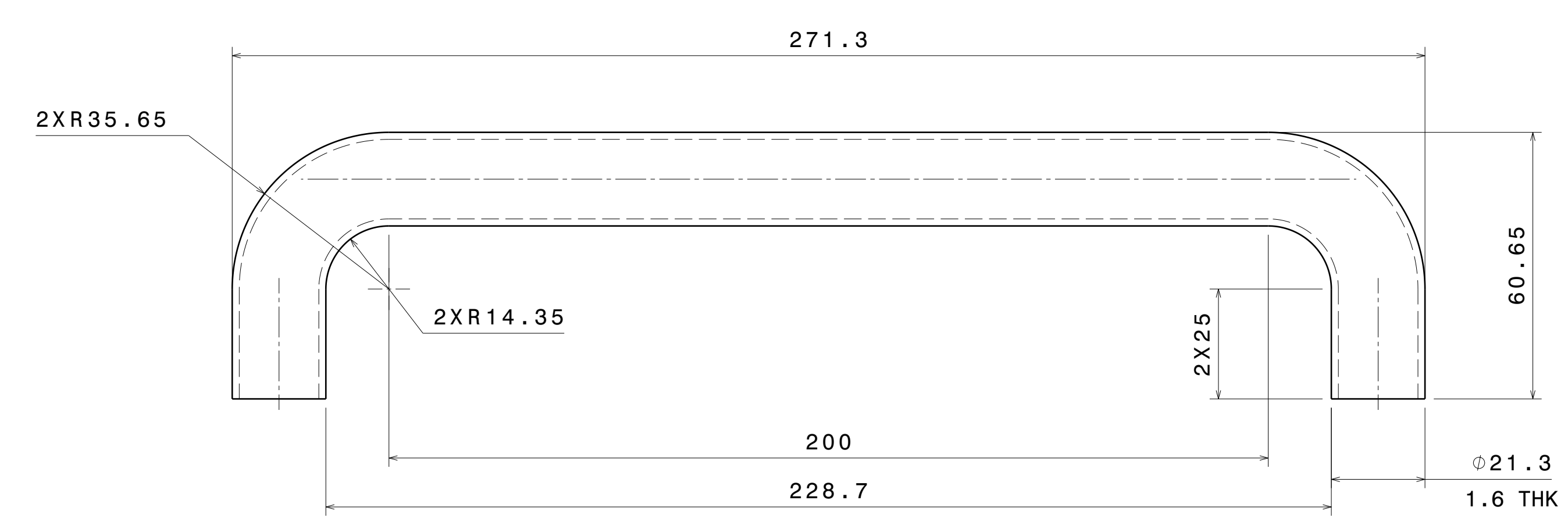

ITEM 6

This drawing is our property. It can't be reproduced or communicated without our written agreement.

APL APOLLO TUBES LTD. 

DRAWN BY	DATE
SB	11NOV2020
CHECKED BY	DATE
P2P Analysis & Solutions	11NOV2020
DESIGNED BY	DATE
P2P Analysis & Solutions	11NOV2020

DRAWING TITLE		NOV 20 11		REV
SIZE	DRAWING NUMBER			00
A0	P2P NOV 20 11			
SCALE	NONE	WEIGHT (kg)	XXX	SHEET 3 OF 3

UNLESS OTHERWISE SPECIFIED DIMENSION ARE IN MM VIEWS: THIRD ANGLE PROJECTION

