

| REV/DATE       | DESCRIPTION      |
|----------------|------------------|
| 00 / 21NOV2020 | INITIAL REVISION |

NOTES:

- (⊥) ALL VERTICAL SUPPORTS ARE PERPENDICULAR.
- FLATNESS OF .5MM IS APPLIED BY DEFAULT.
- ⊥ WELD BEAD OF 2MM RADIUS IS FOLLOWED.
- ▽ SURFACE FINISH MEDIUM TO SMOOTH IS USED.
- ALL TUBES ARE AS PER APL APOLLO STANDARD. CHANGES MAY EFFECT THE LOAD CAPACITY.
- ALL HORIZONTAL AND VERTICAL TUBES ARE PERPENDICULAR TO EACH OTHER WITH ±1 DEG.
- FINE WELDING IS REQUIRED AS PER MENTIONED DETAILS AND FINISHING.
- HIGHER CURRENT WELDING MAY AFFECT THE BRITTLENESS OF MATERIAL WHICH LATER MAY RAISE TO WEAKENING OF STRUCTURE.
- FABRICATORS ARE ALLOWED TO USE FITTINGS/FRAMES/SUPPORTS AS NEEDED AND THE SAME MUST BE COMMUNICATED BACK TO ENGINEERING TEAM.
- BOP COMPONENT WEIGHTS ARE FOR REFERENCE ONLY AND SUBJECTED TO CHANGE PER PURCHASED COMPONENTS.

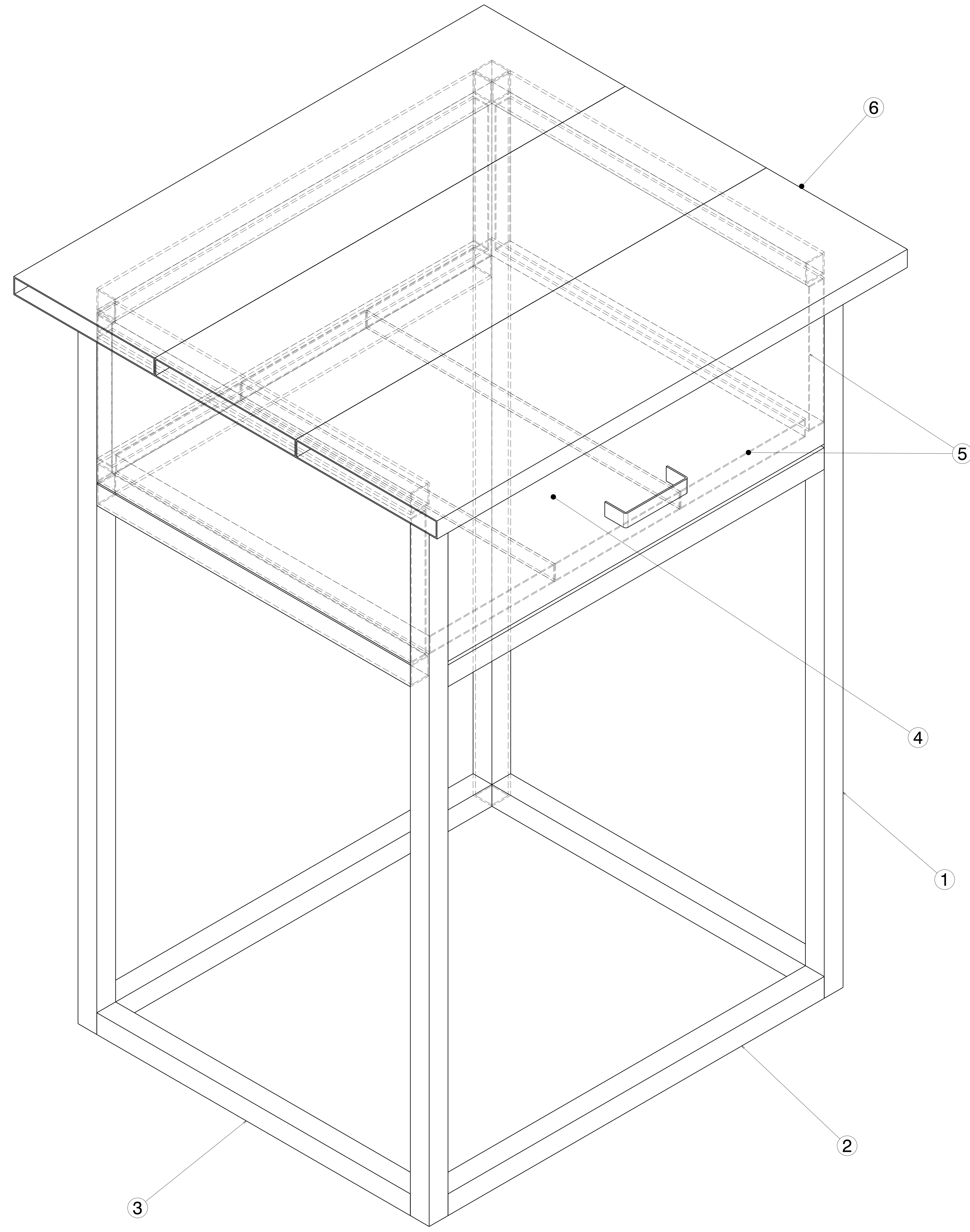

Isometric view  
Scale: 1:2

| ITEM NO. | PART NUMBER | DESCRIPTION          | QTY | Wt (kg)/Each |
|----------|-------------|----------------------|-----|--------------|
| 6        | PLANK 3     | 225 X 25 X 1.6 X 750 | 3   | 4.66         |
| 5        | PLANK 2     | 200 X 25 X 1.6 X 500 | 5   | 2.79         |
| 4        | PLANK 1     | 200 X 25 X 1.6 X 600 | 2   | 3.35         |
| 3        | SHS 3       | 30 X 30 X 2 X 500    | 6   | 0.88         |
| 2        | SHS 2       | 30 X 30 X 2 X 600    | 6   | 1.06         |
| 1        | SHS 1       | 30 X 30 X 2 X 1000   | 4   | 1.76         |

|   |  |   |  |   |  |                                    |  |                              |  |
|---|--|---|--|---|--|------------------------------------|--|------------------------------|--|
| UNLESS OTHERWISE SPECIFIED DIMENSION ARE IN MM<br>VIEWS: THIRD ANGLE PROJECTION                     |  | DRAWN BY: SB<br>CHECKED BY: P2P Analysis & Solutions<br>DESIGNED BY: P2P Analysis & Solutions |  | DATE: 21NOV2020<br>DATE: 21NOV2020<br>DATE: 21NOV2020 |  | DESCRIPTION: APL APOLLO TUBES LTD. |  | QTY: 4<br>Wt (kg)/Each: 1.76 |  |
| This drawing is our property. It can't be reproduced or communicated without our written agreement. |  |   |  |   |  | APL APOLLO TUBES LTD.              |  |                              |  |
| DRAWING TITLE: NOV 20 19  |  |   |  |   |  | SIZE: A0                           |  |                              |  |
| DRAWING NUMBER: P2P NOV 20 19   |  |   |  |   |  | REV: 00                            |  |                              |  |
| SCALE: As Indicated   |  |   |  |   |  | WEIGHT (kg): 0kg                   |  | SHEET 1 OF 3                 |  |

| REV | DATE      | DESCRIPTION      |
|-----|-----------|------------------|
| 00  | 21NOV2020 | INITIAL REVISION |

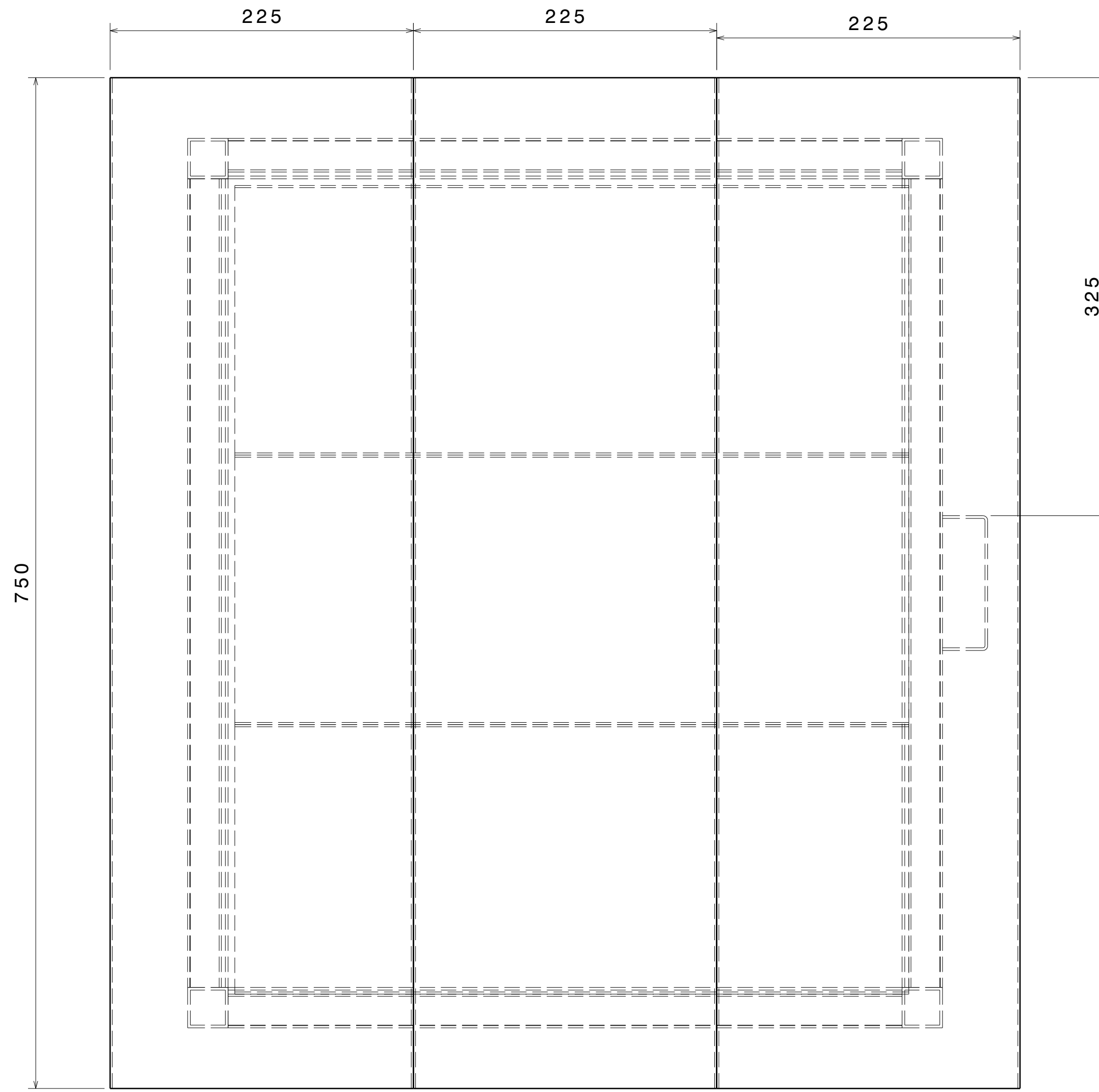

Top view  
Scale: 7:20

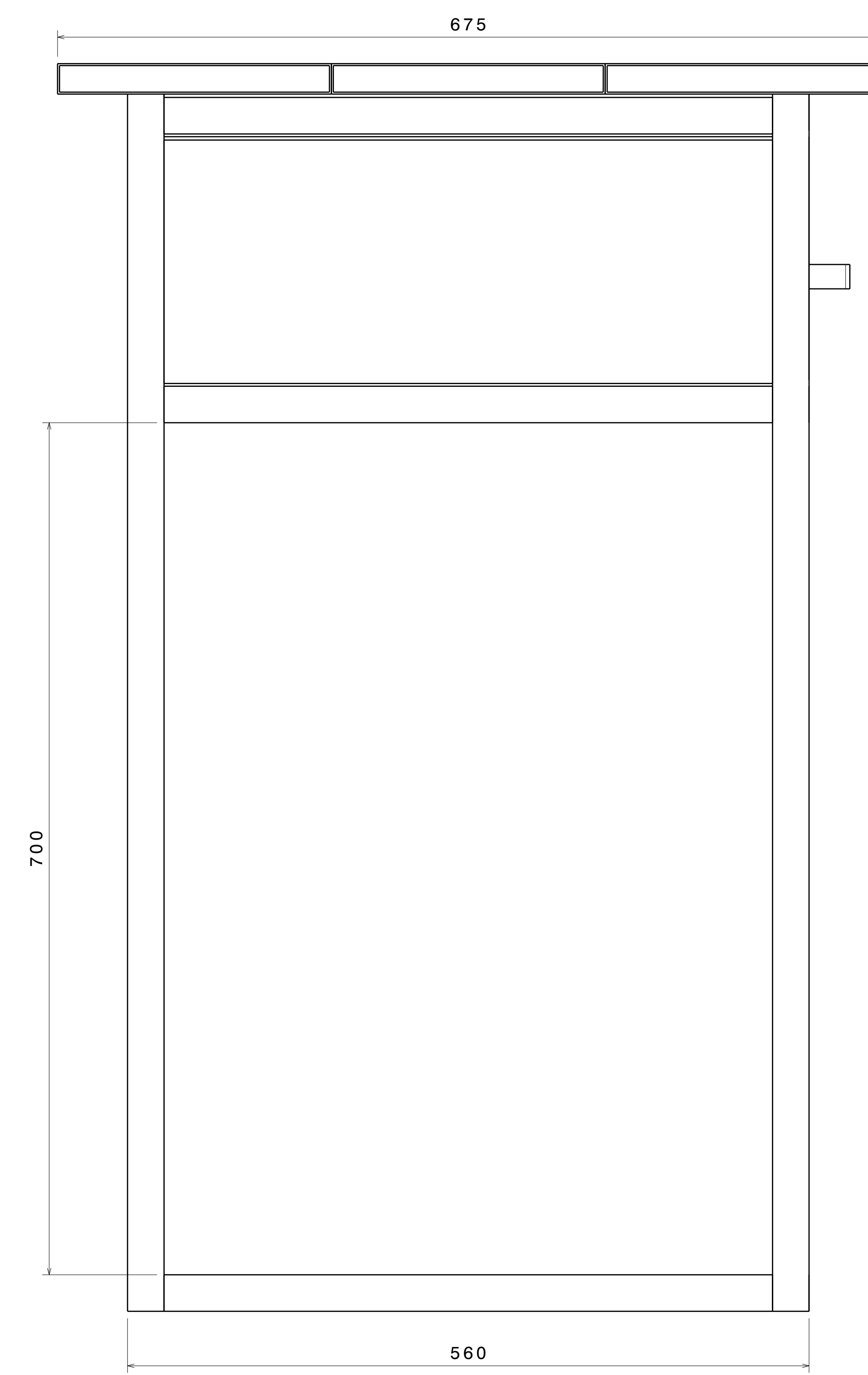

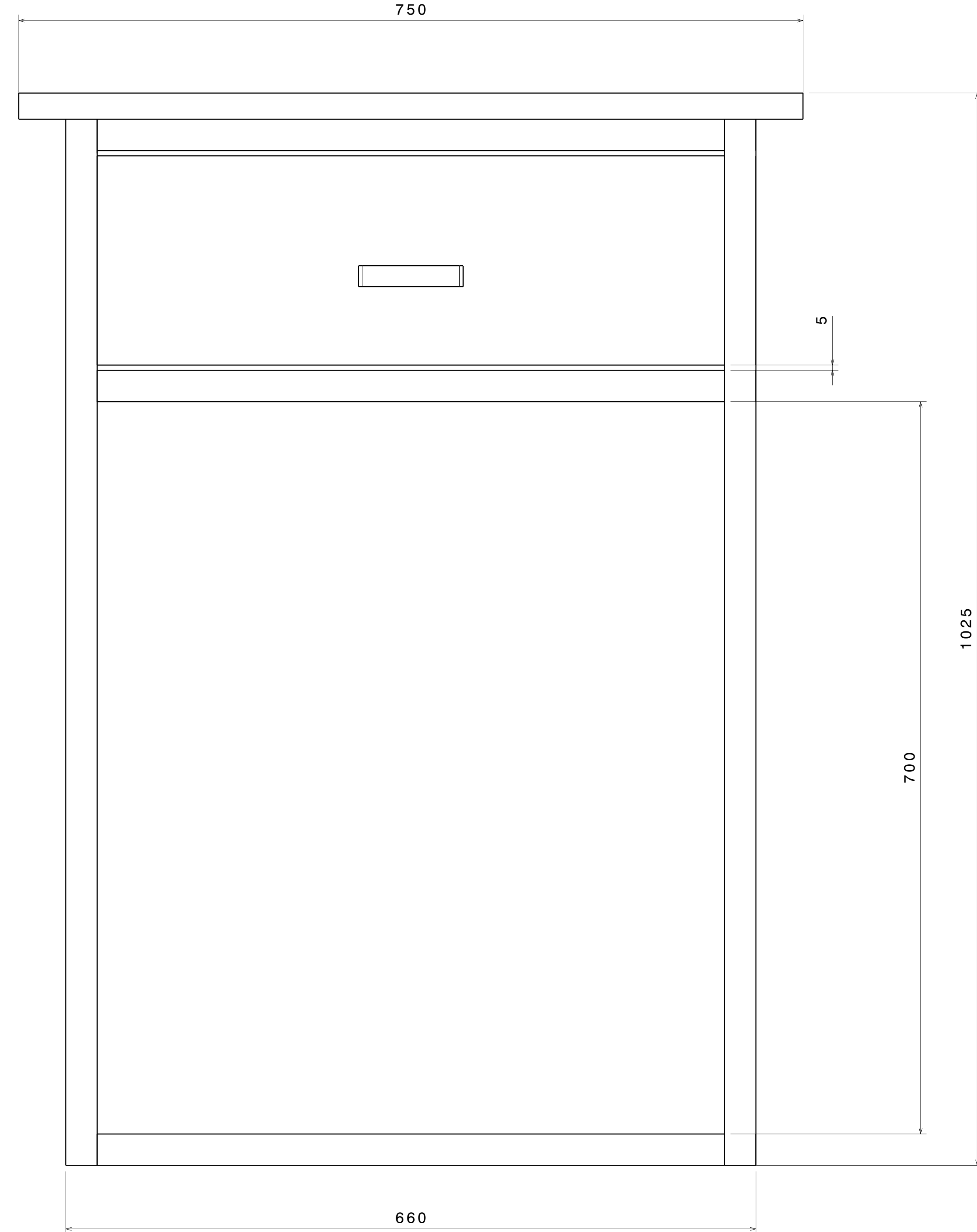

Front view  
Scale: 7:20

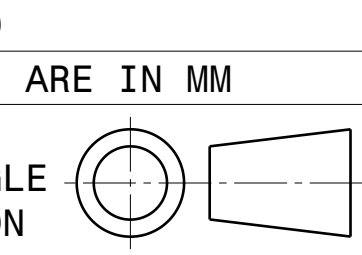

Right view  
Scale: 7:20

UNLESS OTHERWISE SPECIFIED DIMENSION ARE IN MM  
VIEWS: THIRD ANGLE PROJECTION



|   |                                 |   |                    |
|---|---------------------------------|---|--------------------|
| This drawing is our property. It can't be reproduced or communicated without our written agreement. |                                 | APL APOLLO TUBES LTD.  |                    |
| DRAWN BY<br>SB  |                                 | DATE<br>21NOV2020   |                    |
| CHECKED BY<br>P2P Analysis & Solutions  |                                 | DATE<br>21NOV2020   |                    |
| DESIGNED BY<br>P2P Analysis & Solutions   |                                 | DATE<br>21NOV2020   |                    |
| DRAWING TITLE<br>NOV 20 19  |                                 | REV<br>00   |                    |
| SIZE<br>A0  | DRAWING NUMBER<br>P2P NOV 20 19 | SCALE<br>NONE   | WEIGHT (kg)<br>XXX |
|   |                                 |   | SHEET 2 OF 3       |

| REV | DATE      | DESCRIPTION      |
|-----|-----------|------------------|
| 00  | 21NOV2020 | INITIAL REVISION |

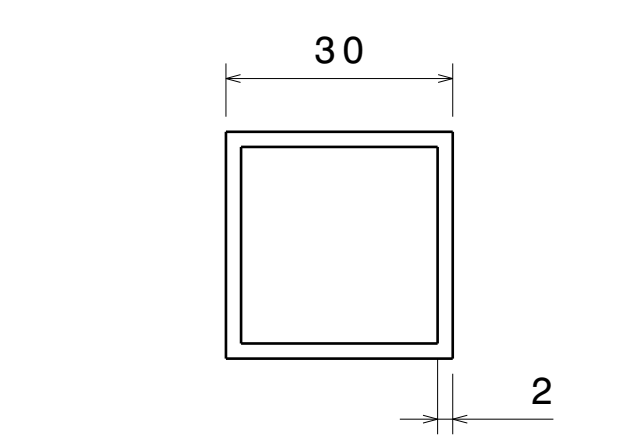
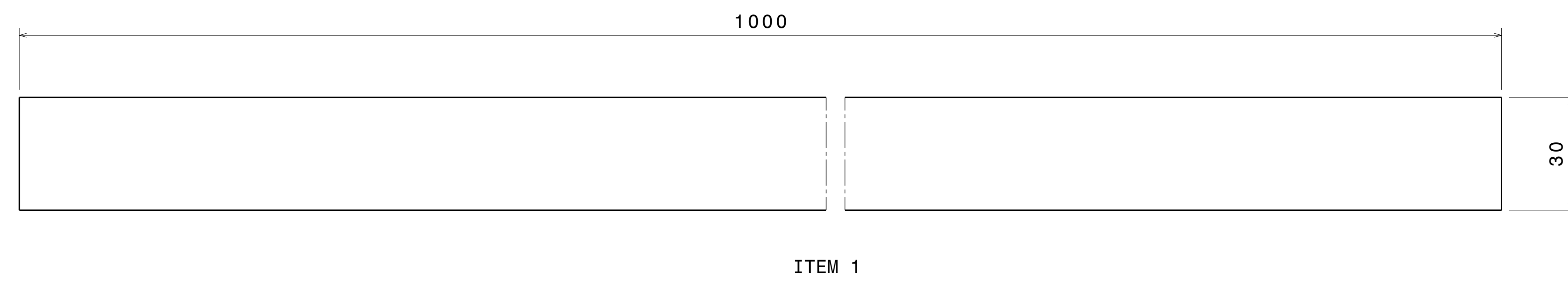

Right view  
TYPICAL FOR ITEM 1, 2, & 3

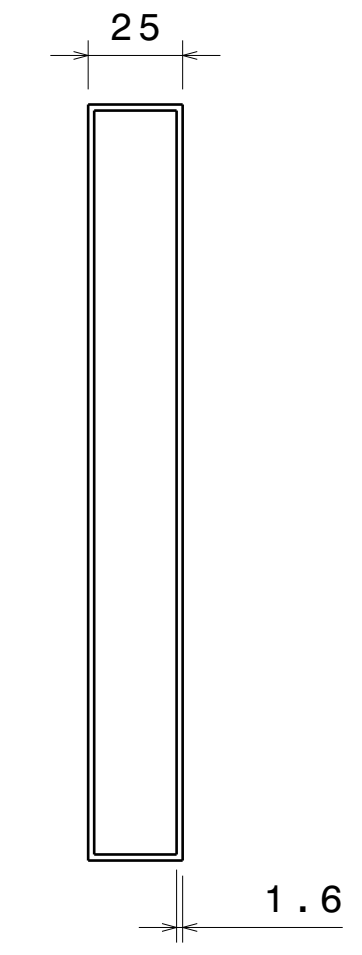
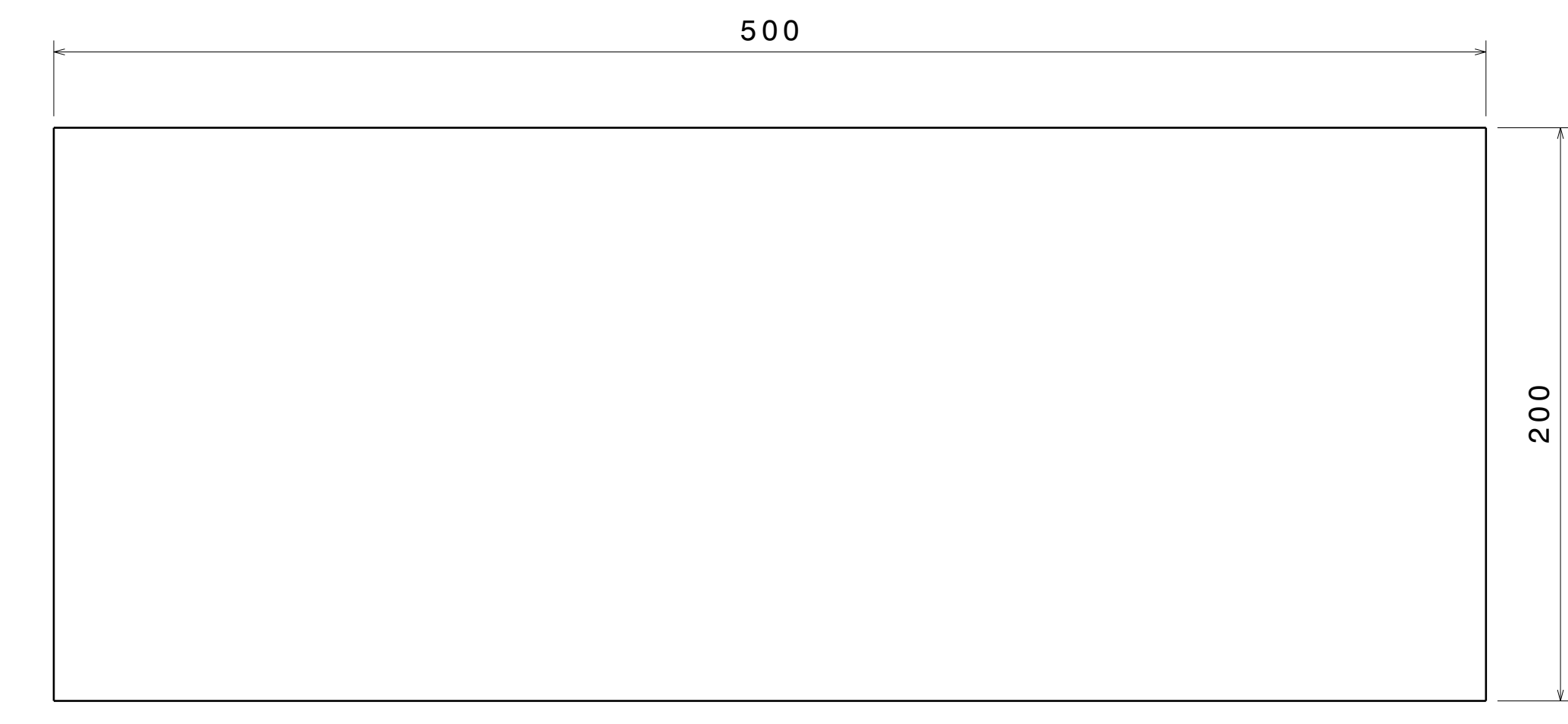

Right view  
Scale: 1:2

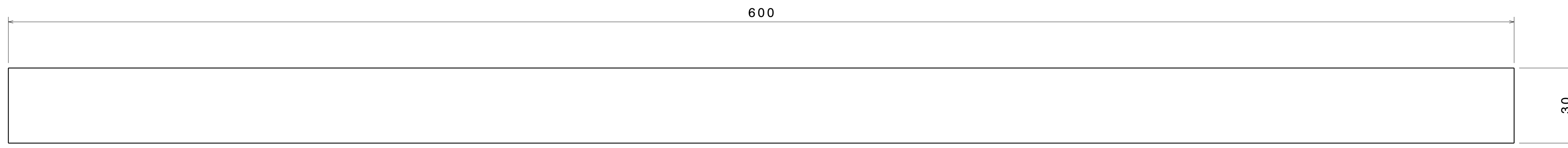

ITEM 2

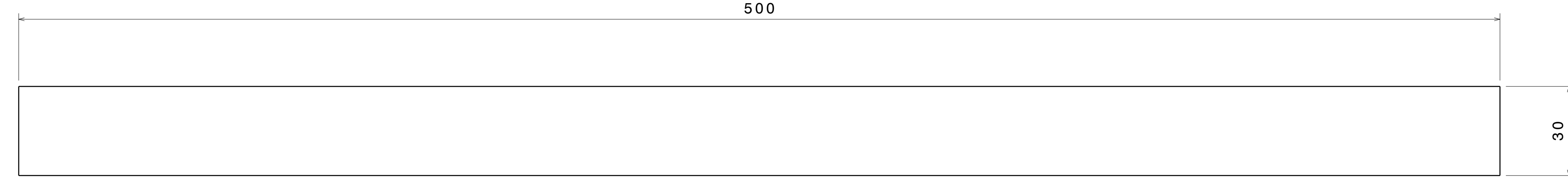

ITEM 3

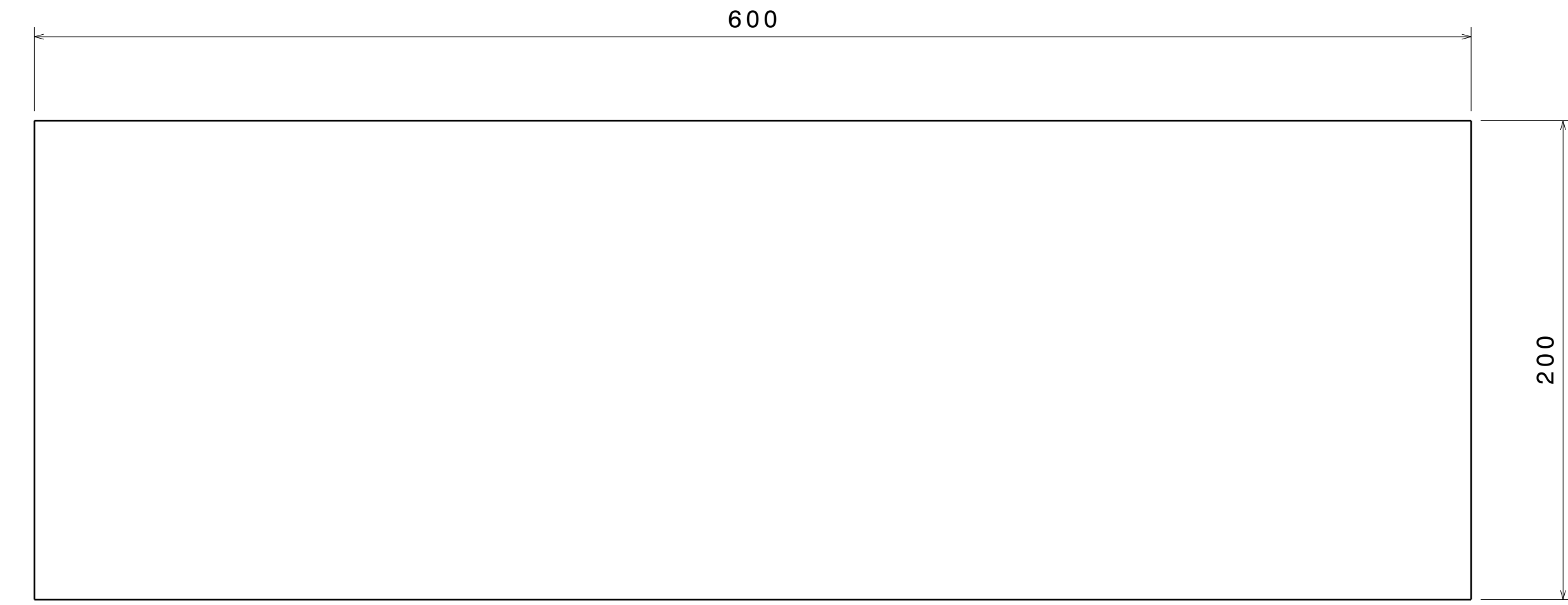

ITEM 4

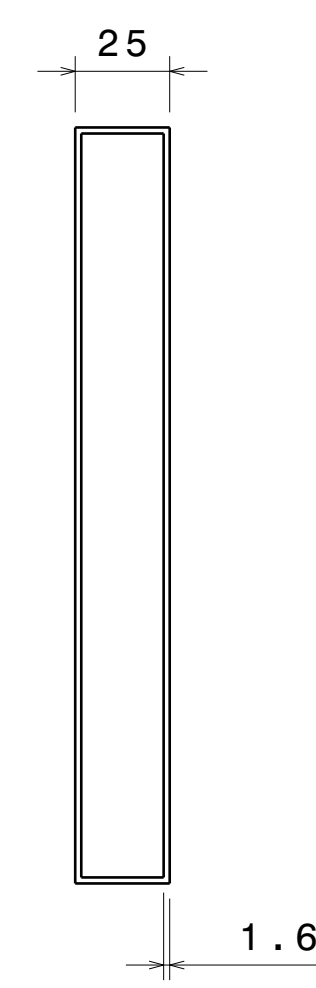

Right view  
Scale: 1:2



ITEM 6

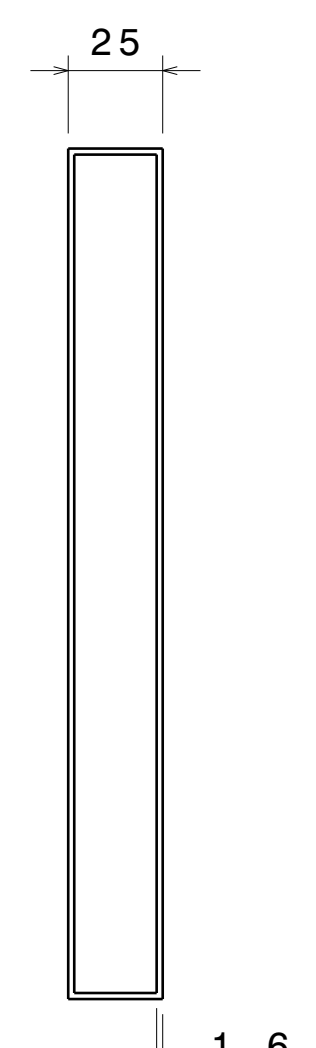

Right view  
Scale: 1:2

UNLESS OTHERWISE SPECIFIED DIMENSION ARE IN MM  
VIEWS: THIRD ANGLE PROJECTION

|   |  |                       |              |
|---|--|-----------------------|--------------|
| This drawing is our property. It can't be reproduced or communicated without our written agreement. |  | APL APOLLO TUBES LTD. |              |
| DRAWN BY<br>SB  |  | DATE<br>21NOV2020     |              |
| CHECKED BY<br>P2P Analysis & Solutions  |  | DATE<br>21NOV2020     |              |
| DESIGNED BY<br>P2P Analysis & Solutions   |  | DATE<br>21NOV2020     |              |
| DRAWING TITLE<br>NOV 20 19  |  | SIZE<br>A0            | REV<br>00    |
| SCALE<br>NONE   |  | WEIGHT (kg)<br>XXX    | SHEET 3 OF 3 |