

REV	DATE	DESCRIPTION
00	27SEPT2020	INITIAL REVISION

- NOTES:
- (⊥) ALL VERTICAL SUPPORTS ARE PERPENDICULAR.
 - FLATNESS OF .5MM IS APPLIED BY DEFAULT.
 - ⊘ WELD BEAD OF 2MM RADIUS IS FOLLOWED.
 - ▽ SURFACE FINISH MEDIUM TO SMOOTH IS USED.
 - ALL TUBES ARE AS PER APL APOLLO STANDARD. CHANGES MAY EFFECT THE LOAD CAPACITY.
 - ALL HORIZONTAL AND VERTICAL TUBES ARE PERPENDICULAR TO EACH OTHER WITH ±1 DEG.
 - FINE WELDING IS REQUIRED AS PER MENTIONED DETAILS AND FINISHING.
 - HIGHER CURRENT WELDING MAY AFFECT THE BRITTLENESS OF MATERIAL WHICH LATER MAY RAISE TO WEAKENING OF STRUCTURE.
 - FABRICATORS ARE ALLOWED TO USE FITTINGS/FRAMES/SUPPORTS AS NEEDED AND THE SAME MUST BE COMMUNICATED BACK TO ENGINEERING TEAM.
 - BOP COMPONENT WEIGHTS ARE FOR REFERENCE ONLY AND SUBJECTED TO CHANGE PER PURCHASED COMPONENTS.

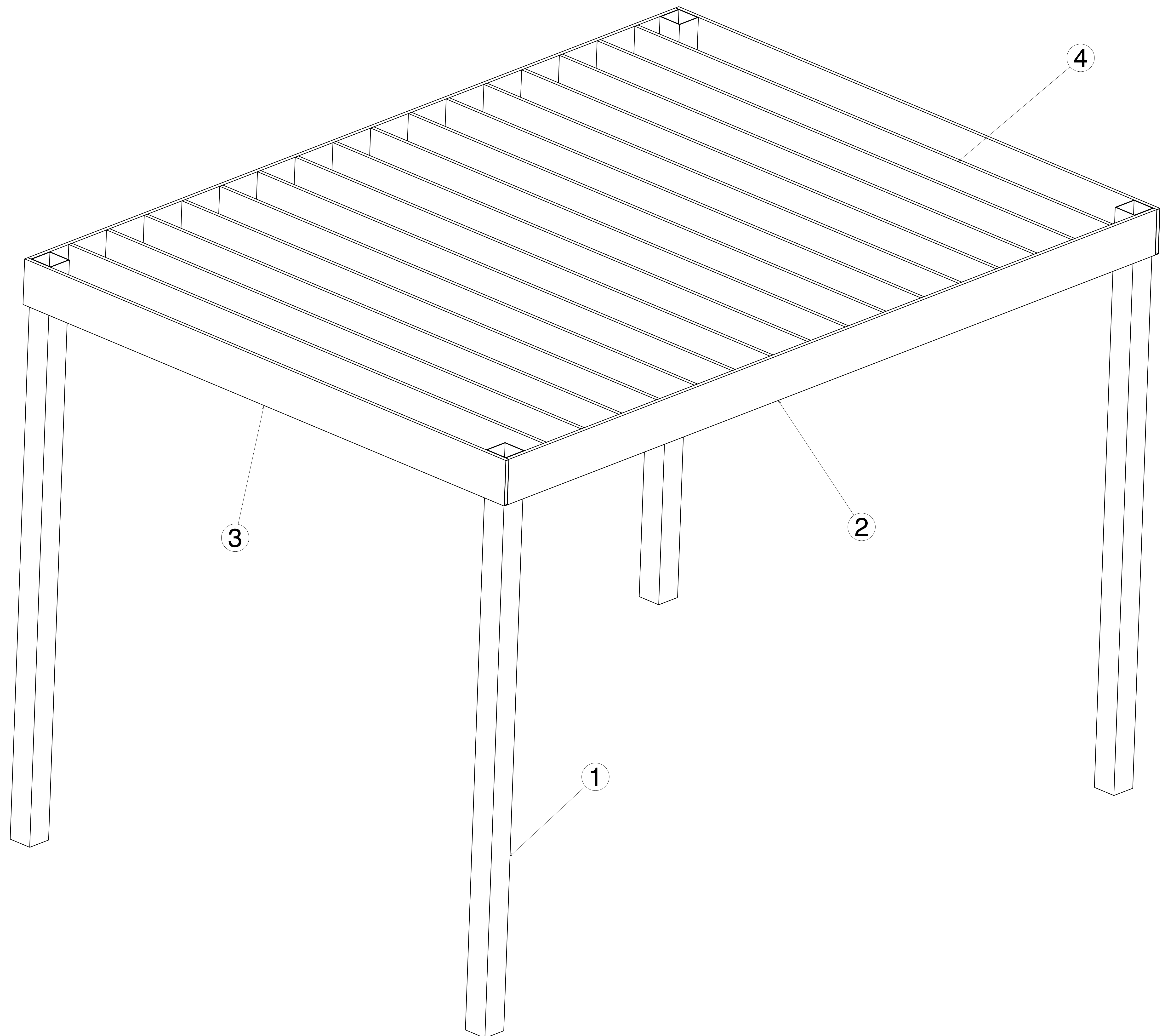

ISOMETRIC VIEW
SCALE:1:10

ITEM NO.	PART NUMBER	DESCRIPTION	QTY.	Wt (kg)/Each
4	RHS PLANK 3	275 X 25 X 1.6 X 3650	16	27.25
3	RHS PLANK 2	275 X 25 X 1.6 X 3700	2	27.62
2	RHS PLANK 1	275 X 25 X 1.6 X 5150	2	38.45
1	SHS FRAME 1	150 X 150 X 4 X 3500	4	64.26

DRAWN BY		DATE	DRAWING TITLE	
VM		27SEPT2020	PATIO DESIGN 6	
CHECKED BY	P2P Analysis & Solutions	DATE	SIZE	DRAWING NUMBER
		27SEPT2020	A0	P2P PATIO DESIGN 6
DESIGNED BY	P2P Analysis & Solutions	DATE	SCALE	WEIGHT(kg)
		27SEPT2020	As Indicated	0kg

UNLESS OTHERWISE SPECIFIED DIMENSION ARE IN MM
VIEWS: THIRD ANGLE PROJECTION

This drawing is our property. It can't be reproduced or communicated without our written agreement.

APL APOLLO TUBES LTD.

16
15
14
13
12
11
10
9
8
7
6
5
4
3
2
1

P
O
N
M
L
K
J
I
H
G
F
E
D
C
B
A

REV	DATE	DESCRIPTION
00	27SEPT2020	INITIAL REVISION

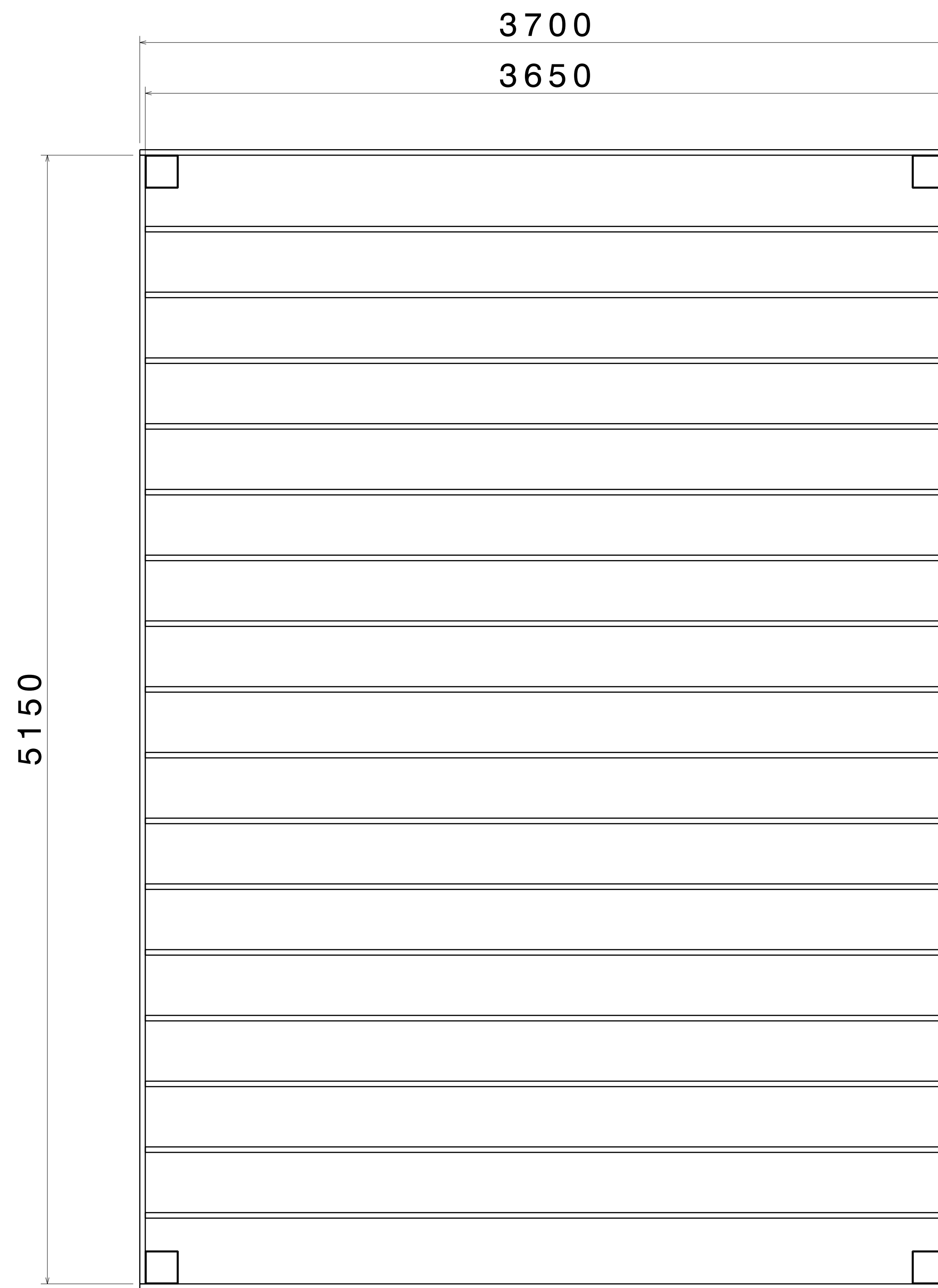

FRONT VIEW
SCALE: 1:15

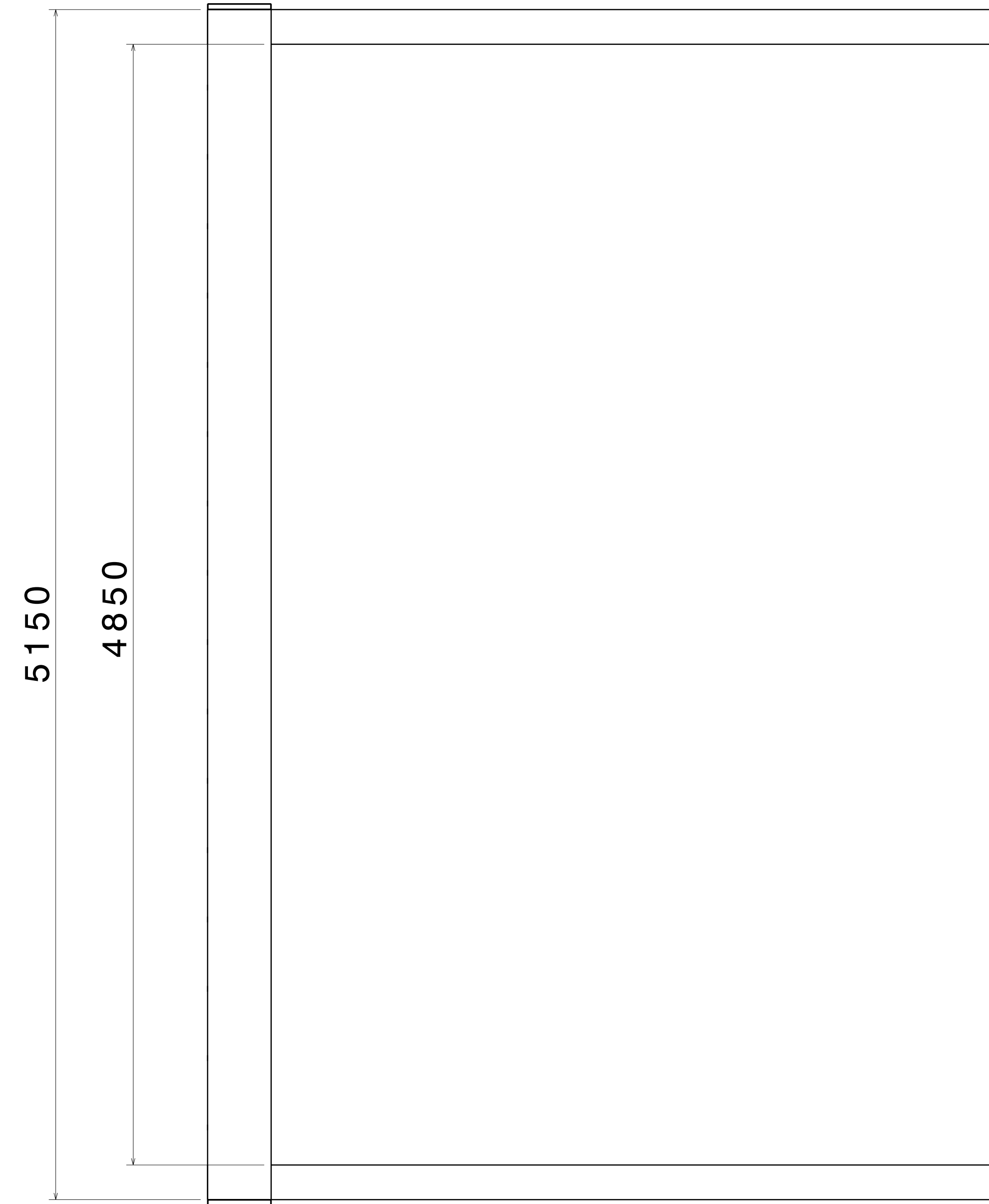

RIGHT VIEW
SCALE: 1:15

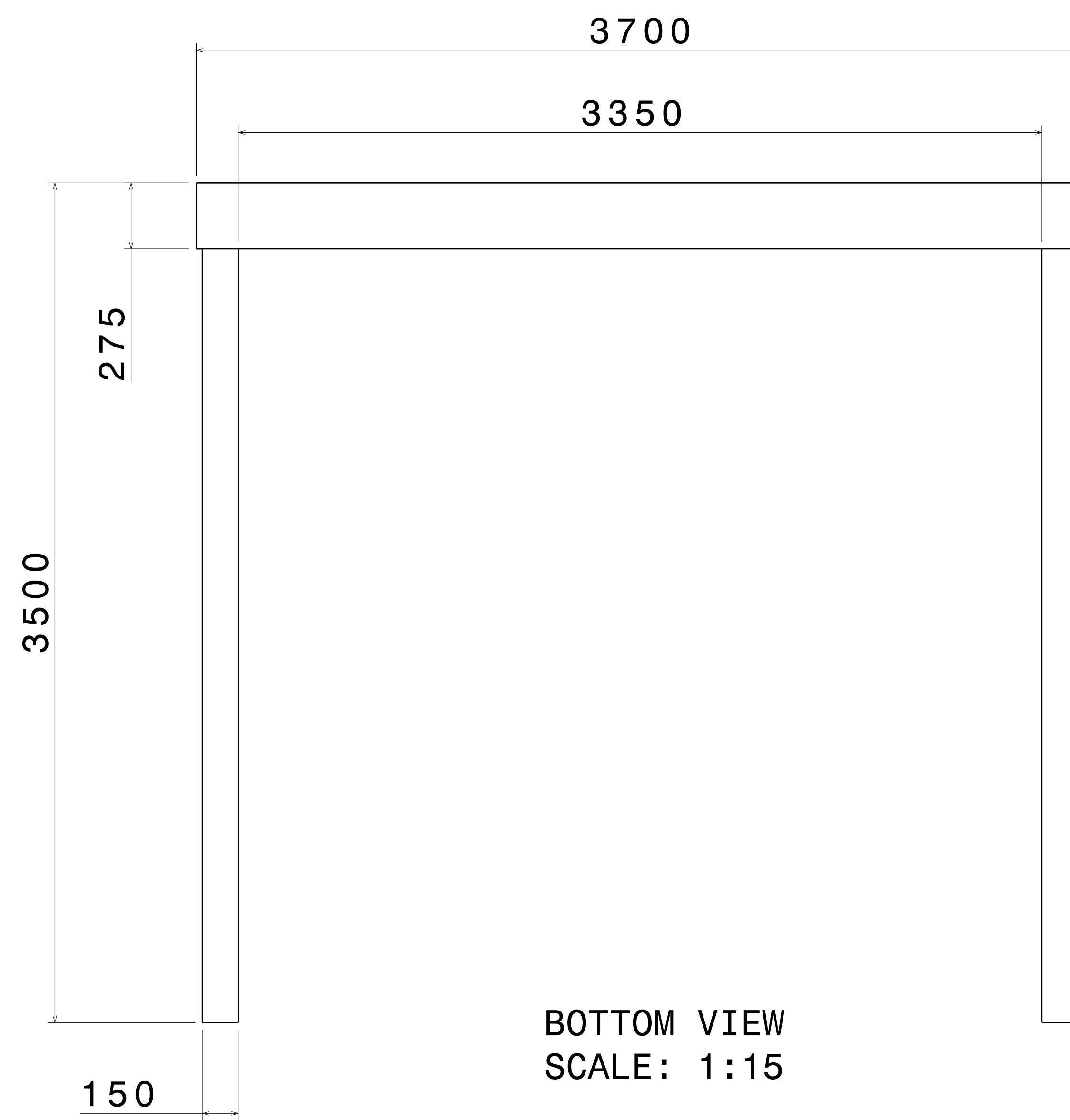

BOTTOM VIEW
SCALE: 1:15

UNLESS OTHERWISE SPECIFIED DIMENSION ARE IN MM
VIEWS: THIRD ANGLE PROJECTION

This drawing is our property. It can't be reproduced or communicated without our written agreement.		APL APOLLO TUBES LTD.	
DRAWN BY SB		DATE 27SEPT2020	
CHECKED BY P2P Analysis & Solutions		DATE 27SEPT2020	
DESIGNED BY P2P Analysis & Solutions		DATE 27SEPT2020	
SIZE A0	DRAWING NUMBER P2P PATIO DESIGN 6		REV 00
SCALE NONE	WEIGHT (kg)	XXX	SHEET 2 OF 3

REV	DATE	DESCRIPTION
00	27SEPT2020	INITIAL REVISION

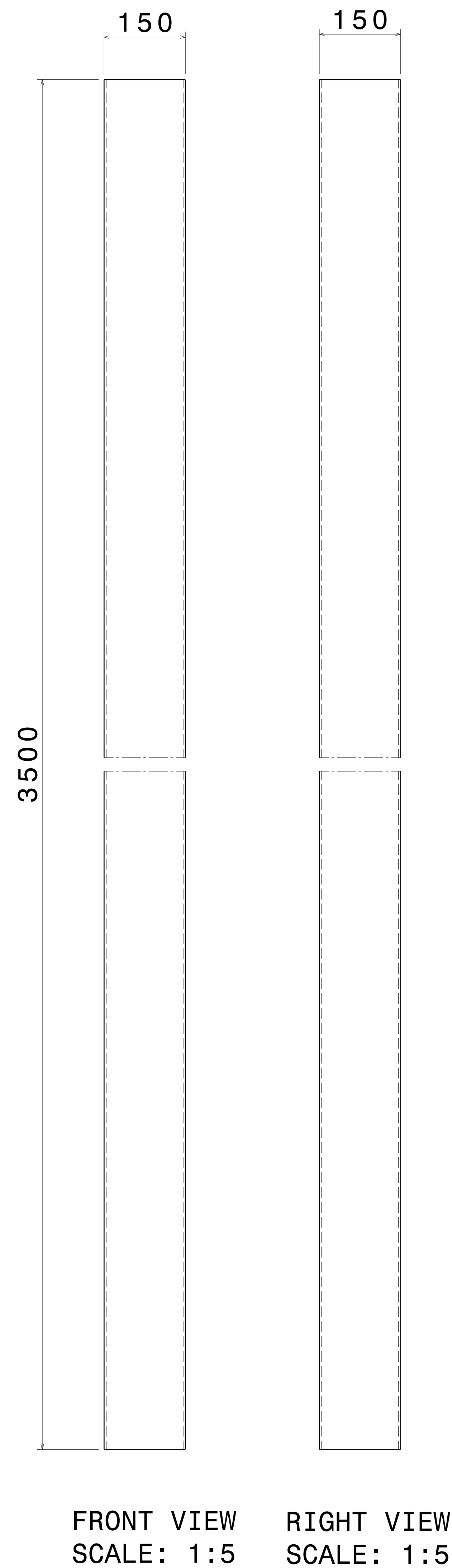

FRONT VIEW RIGHT VIEW
SCALE: 1:5 SCALE: 1:5

ITEM 1, SHS FRAME 1
THICKNESS - 4.0MM

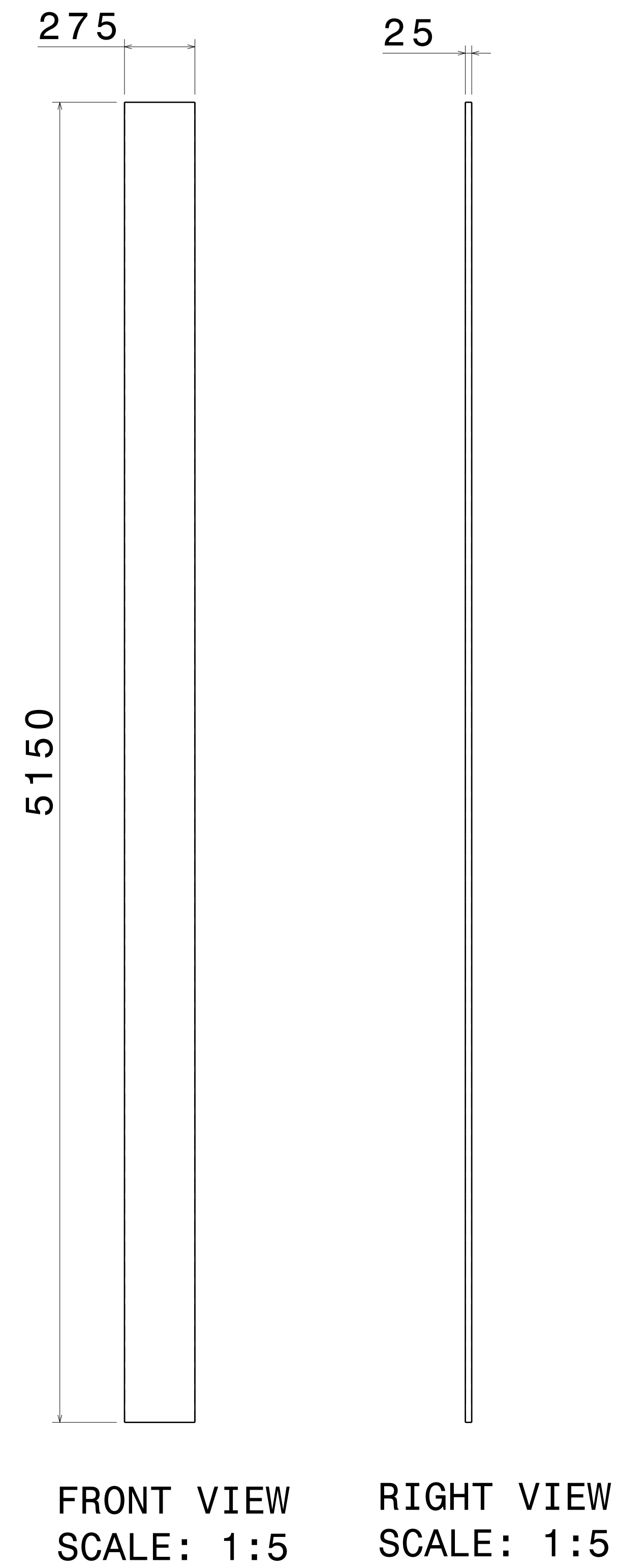

FRONT VIEW RIGHT VIEW
SCALE: 1:5 SCALE: 1:5

ITEM 2, RHS PLANK 1
THICKNESS - 1.6 MM

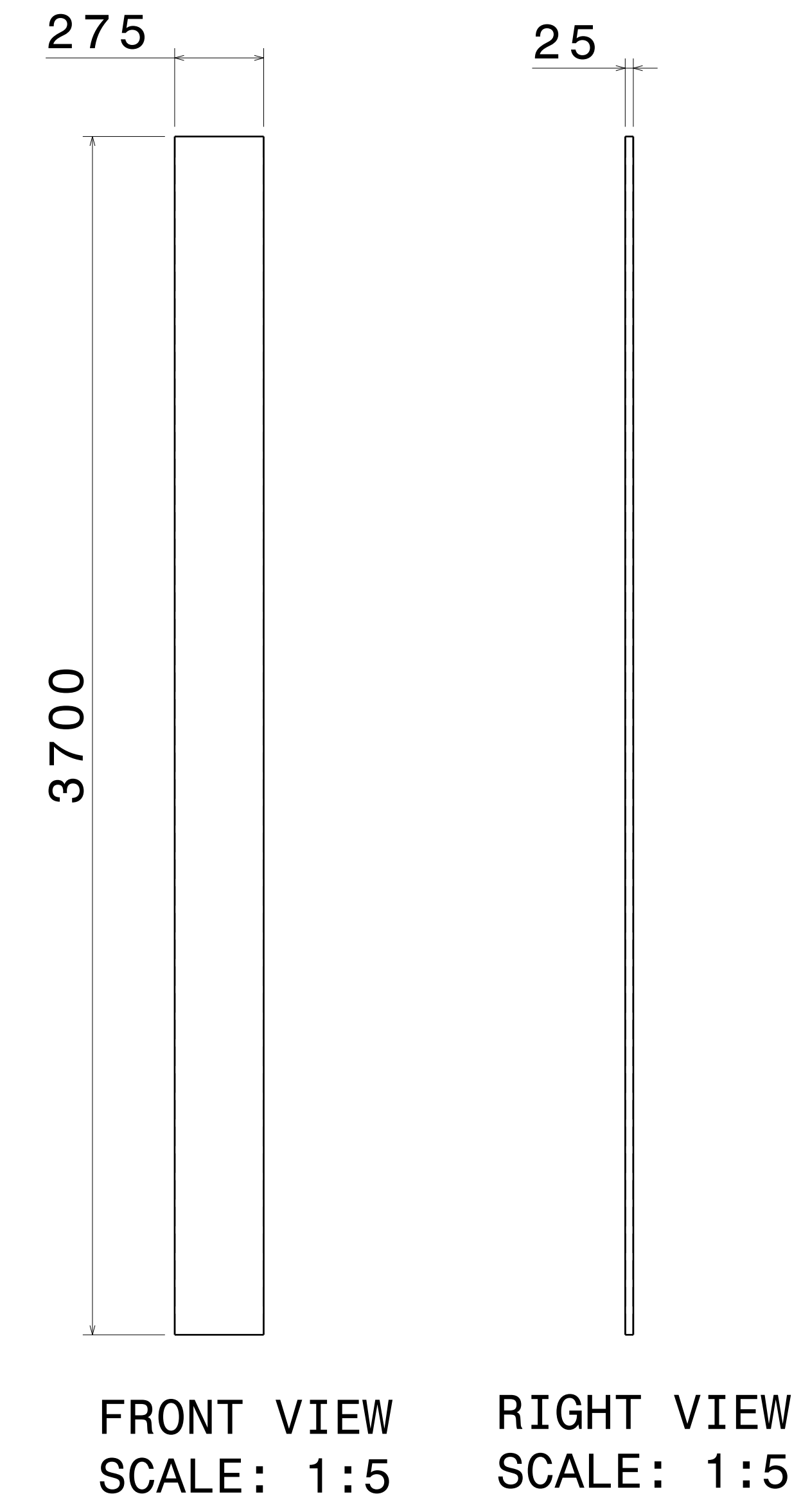

FRONT VIEW RIGHT VIEW
SCALE: 1:5 SCALE: 1:5

ITEM 3, RHS PLANK 2
THICKNESS - 1.6 MM

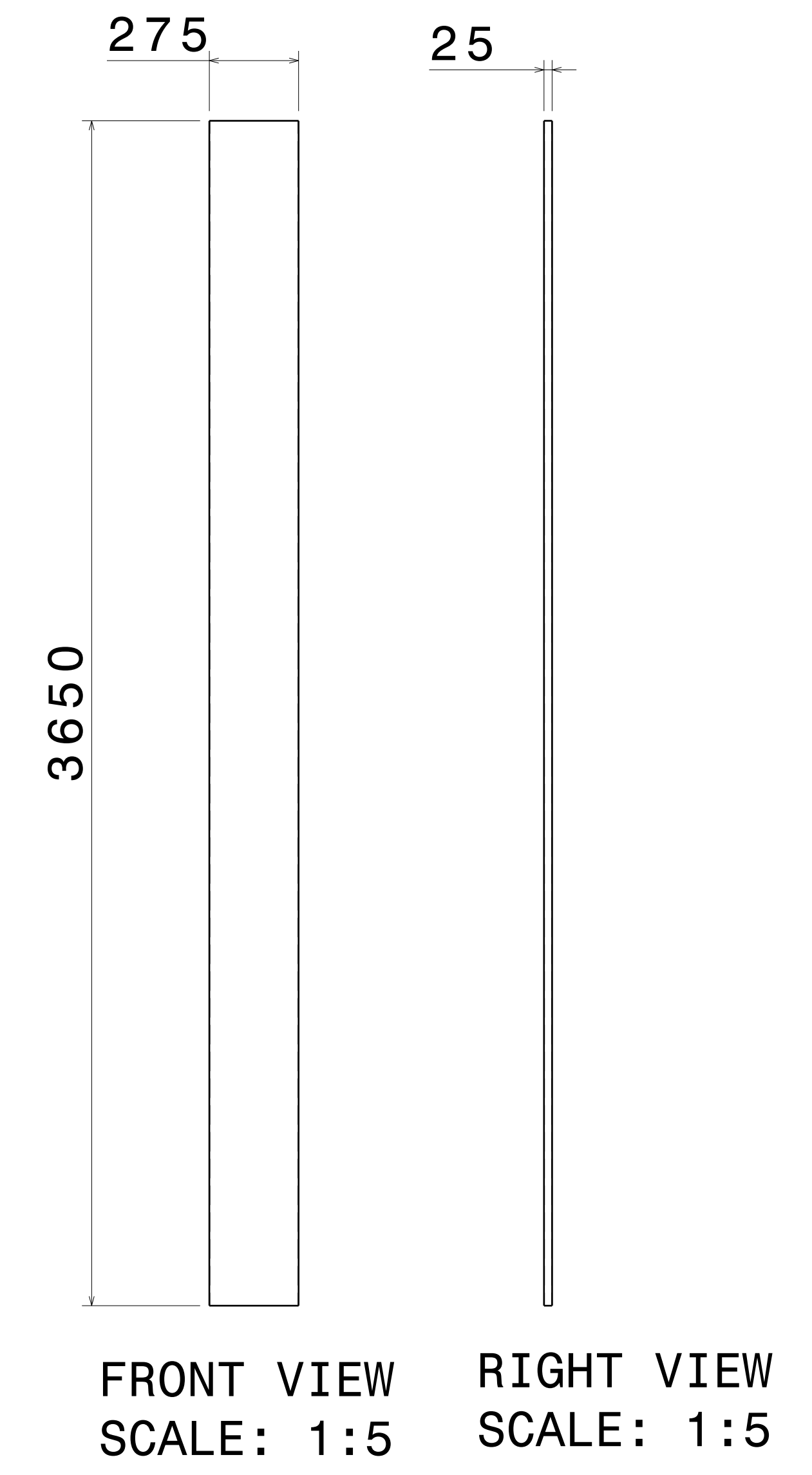

FRONT VIEW RIGHT VIEW
SCALE: 1:5 SCALE: 1:5

ITEM 4, RHS PLANK 3
THICKNESS - 1.6 MM

UNLESS OTHERWISE SPECIFIED DIMENSION ARE IN MM
VIEWS: THIRD ANGLE PROJECTION

This drawing is our property. It can't be reproduced or communicated without our written agreement.		APL APOLLO TUBES LTD.	
DRAWN BY SB		DATE 27SEPT2020	
CHECKED BY P2P Analysis & Solutions		DATE 27SEPT2020	
DESIGNED BY P2P Analysis & Solutions		DATE 27SEPT2020	
SCALE NONE	WEIGHT (kg) XXX	DRAWING NUMBER A0 P2P PATIO DESIGN 6	
SHEET 3 OF 3		REV 00	