

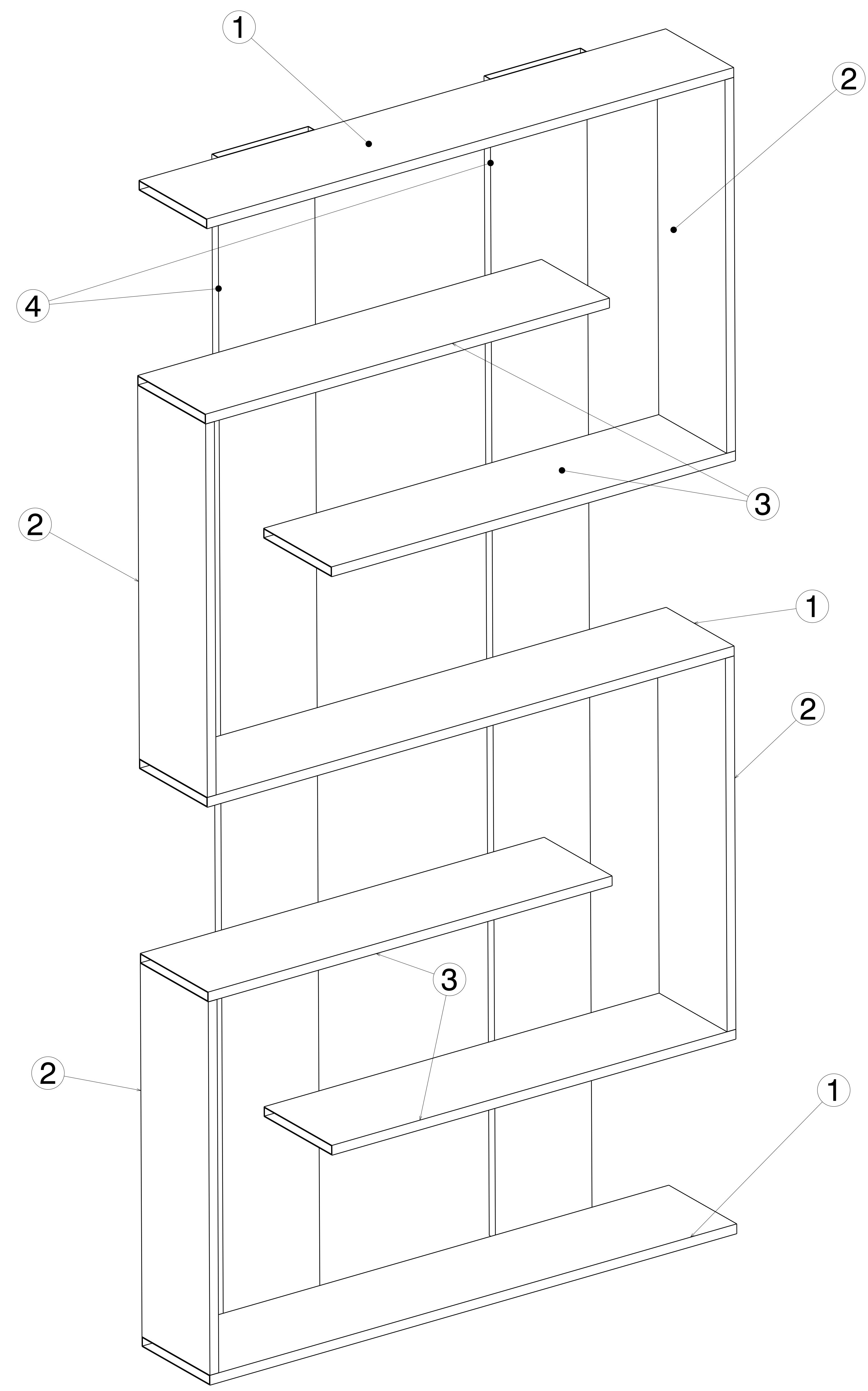

REV/DATE	DESCRIPTION
00 / 21SEPT2020	INITIAL REVISION

- NOTES:
- (⊥) ALL VERTICAL SUPPORTS ARE PERPENDICULAR.
 - FLATNESS OF .5MM IS APPLIED BY DEFAULT.
 - ⊲ WELD BEAD OF 2MM RADIUS IS FOLLOWED.
 - ▽▽ SURFACE FINISH MEDIUM TO SMOOTH IS USED.
 - ALL TUBES ARE AS PER APL APOLLO STANDARD. CHANGES MAY EFFECT THE LOAD CAPACITY.
 - ALL HORIZONTAL AND VERTICAL TUBES ARE PERPENDICULAR TO EACH OTHER WITH ±1 DEG.
 - FINE WELDING IS REQUIRED AS PER MENTIONED DETAILS AND FINISHING.
 - HIGHER CURRENT WELDING MAY AFFECT THE BRITTLENESS OF MATERIAL WHICH LATER MAY RAISE TO WEAKENING OF STRUCTURE.
 - FABRICATORS ARE ALLOWED TO USE FITTINGS/FRAMES/SUPPORTS AS NEEDED AND THE SAME MUST BE COMMUNICATED BACK TO ENGINEERING TEAM.
 - BOP COMPONENT WEIGHTS ARE FOR REFERENCE ONLY AND SUBJECTED TO CHANGE PER PURCHASED COMPONENTS.



ISOMETRIC VIEW
SCALE: 1:5

ITEM NO.	PART NUMBER	DESCRIPTION	QTY.	Wt (kg)/Each
4	RHS PLANK 4	275 X 25 X 2 X 2950	2	22
3	RHS PLANK 3	275 X 25 X 2 X 1150	4	10.7
2	RHS PLANK 2	275 X 25 X 2 X 950	4	8.8
1	RHS PLANK 1	275 X 25 X 2 X 1500	3	13.96

This drawing is our property. It can't be reproduced or communicated without our written agreement.		APL APOLLO TUBES LTD. 	
DRAWN BY VM		DATE 21SEPT2020	
CHECKED BY P2P Analysis & Solutions		DATE 21SEPT2020	
DESIGNED BY P2P Analysis & Solutions		DATE 21SEPT2020	
SIZE A0	DRAWING NUMBER P2P SHELF 2	REV 00	
SCALE As Indicated	WEIGHT(kg) 0kg	SHEET 1 OF 3	

UNLESS OTHERWISE SPECIFIED DIMENSION ARE IN MM
VIEWS: THIRD ANGLE PROJECTION

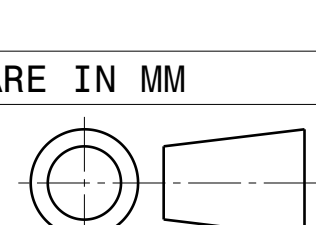

REV	DATE	DESCRIPTION
00	21SEPT2020	INITIAL REVISION

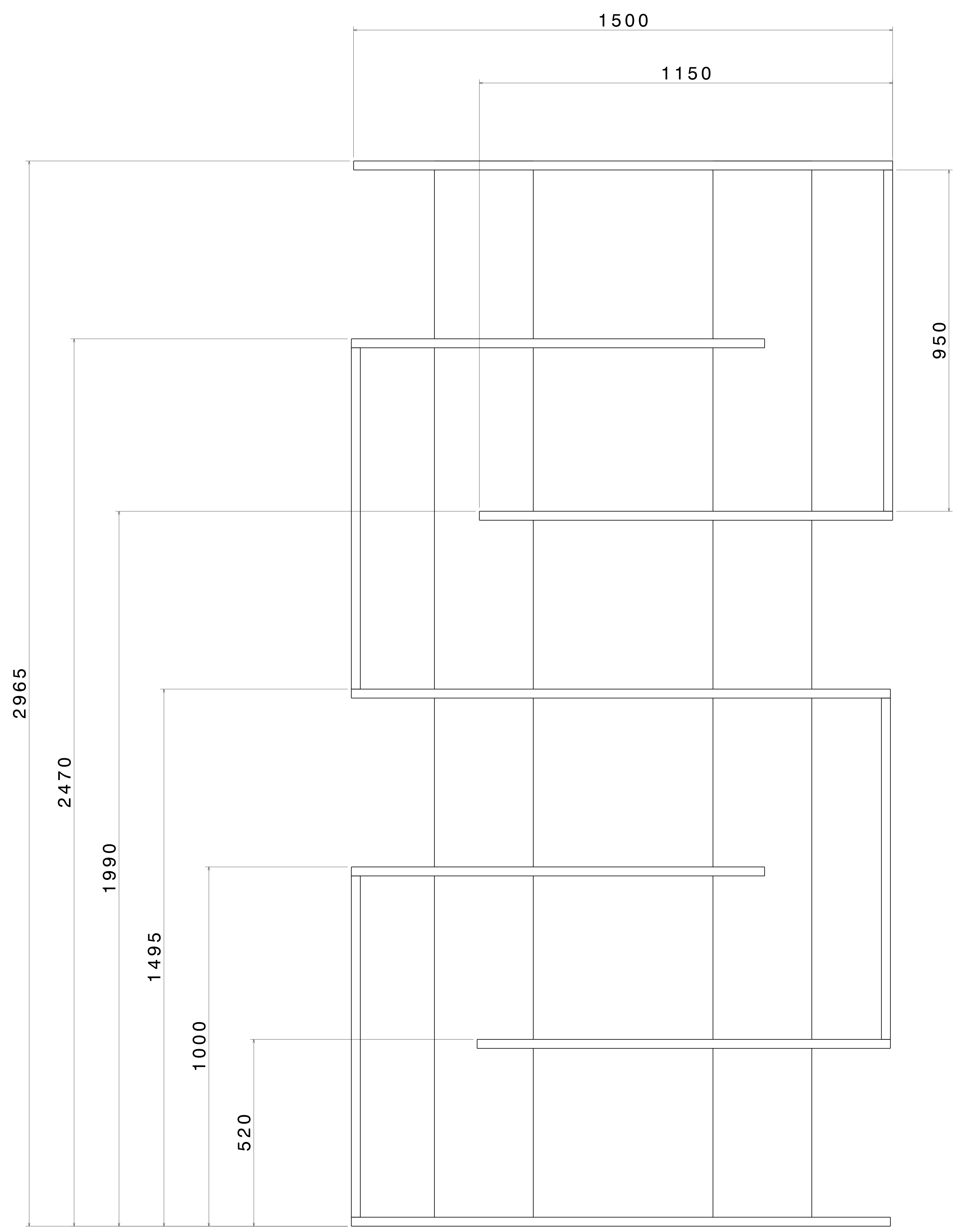

FRONT VIEW
SCALE: 1:5

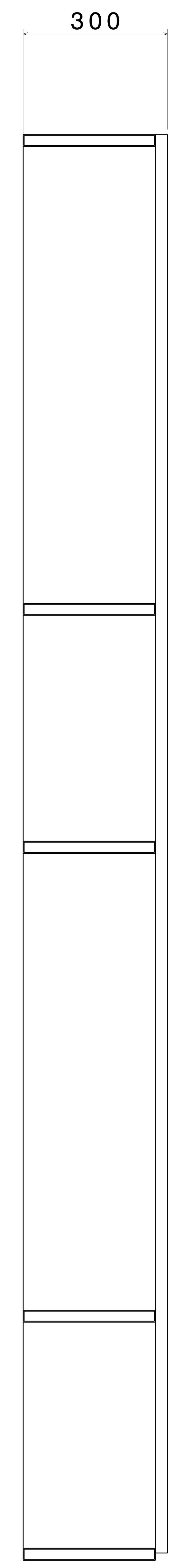

RIGHT VIEW
SCALE: 1:5

UNLESS OTHERWISE SPECIFIED DIMENSION ARE IN MM
VIEWS: THIRD ANGLE PROJECTION

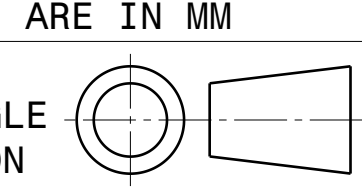

This drawing is our property. It can't be reproduced or communicated without our written agreement.

DRAWN BY	DATE
SB	21SEPT2020
CHECKED BY	DATE
P2P Analysis & Solutions	21SEPT2020
DESIGNED BY	DATE
P2P Analysis & Solutions	21SEPT2020

APL APOLLO TUBES LTD. 	
DRAWING TITLE	
SHELF 2	
SIZE	DRAWING NUMBER
A0	P2P SHELF 2
SCALE	WEIGHT (kg)
NONE	XXX
REV	SHEET 2 OF 3
00	

REV	DATE	DESCRIPTION
00	21SEPT2020	INITIAL REVISION

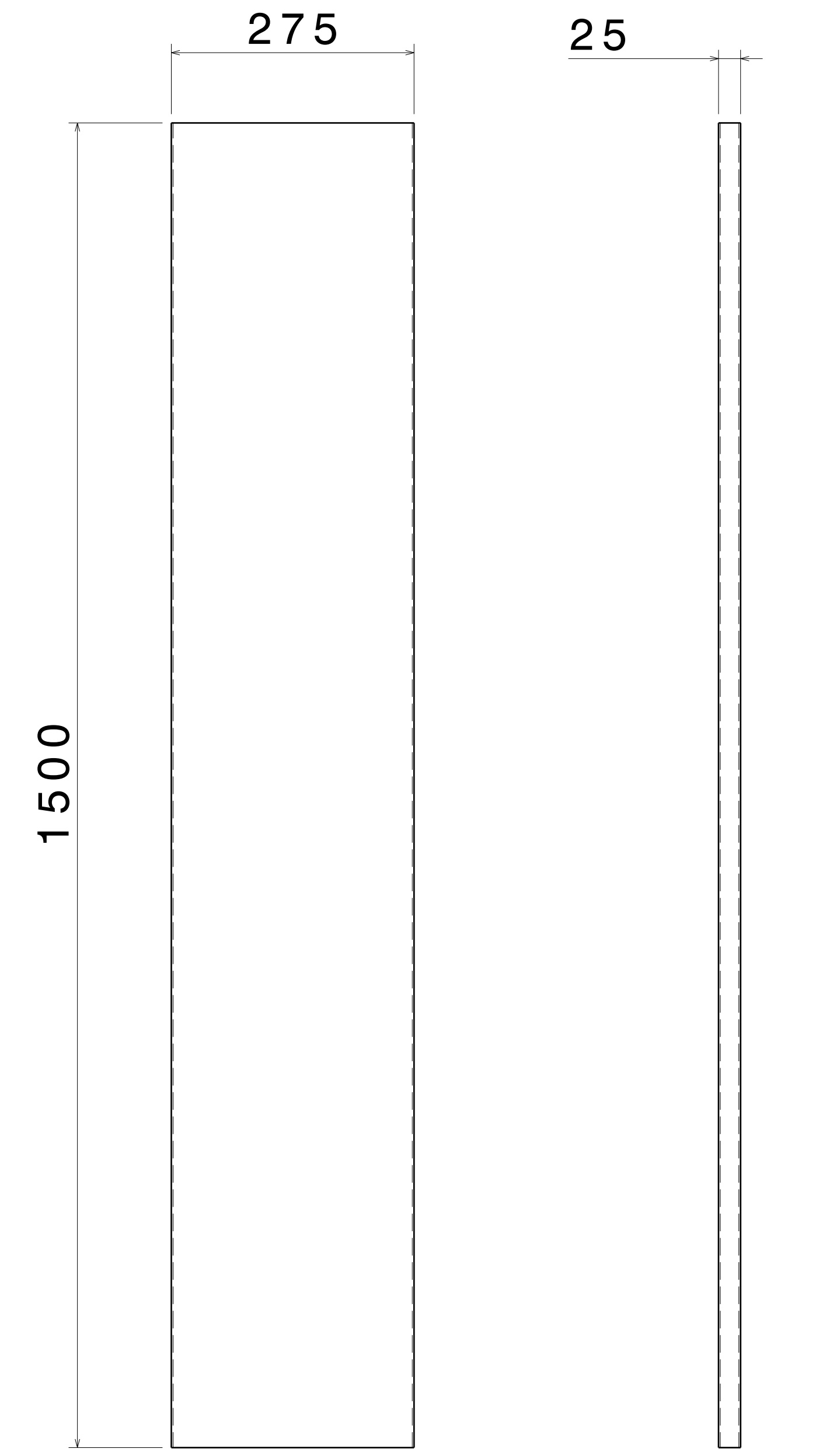

FRONT VIEW
SCALE: 1:5

RIGHT VIEW
SCALE: 1:5

ITEM 1, RHS PLANK 1
THICKNESS - 2.0MM

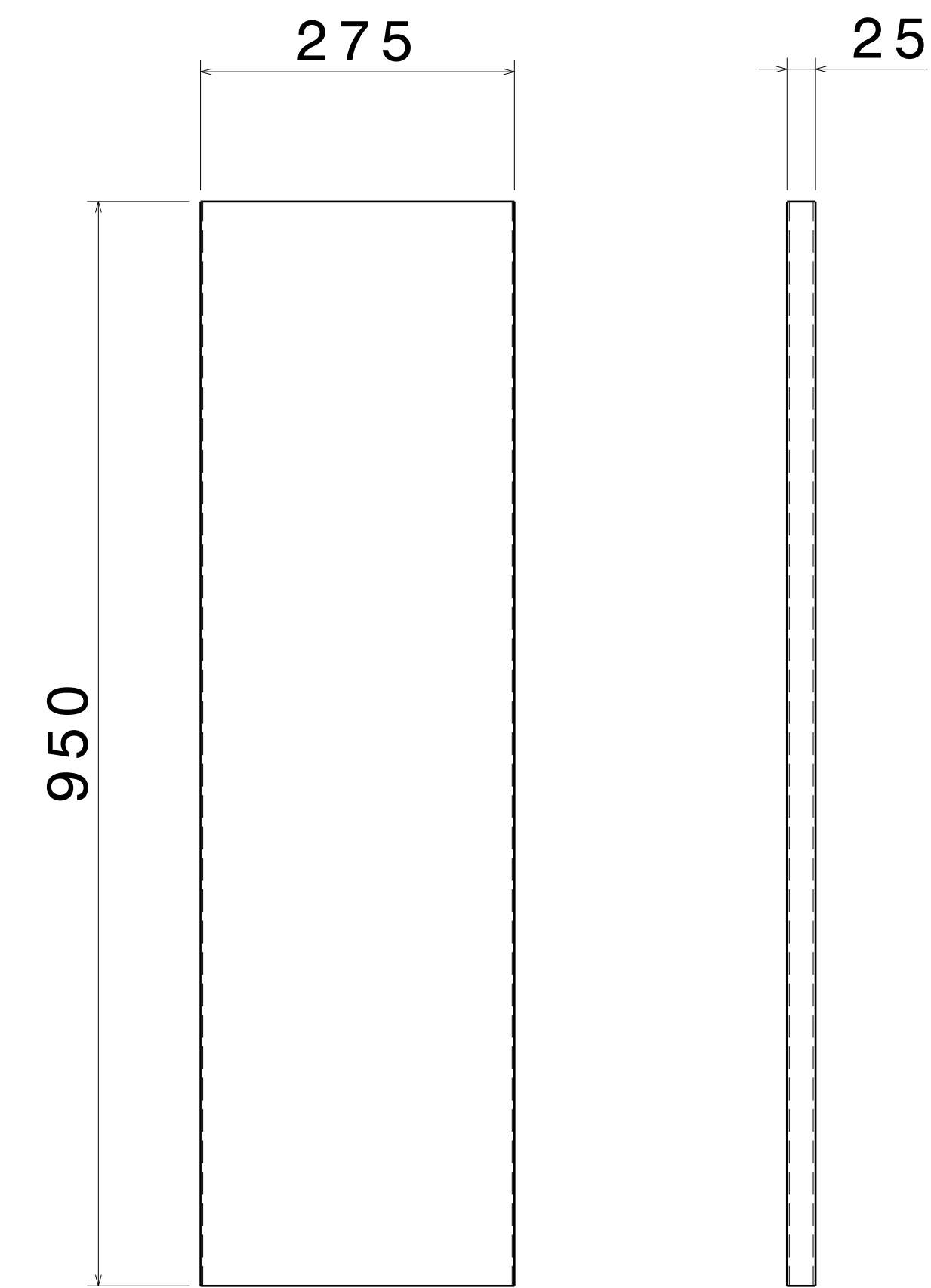

FRONT VIEW
SCALE: 1:5

RIGHT VIEW
SCALE: 1:5

ITEM 2, RHS PLANK 2
THICKNESS - 2.0MM

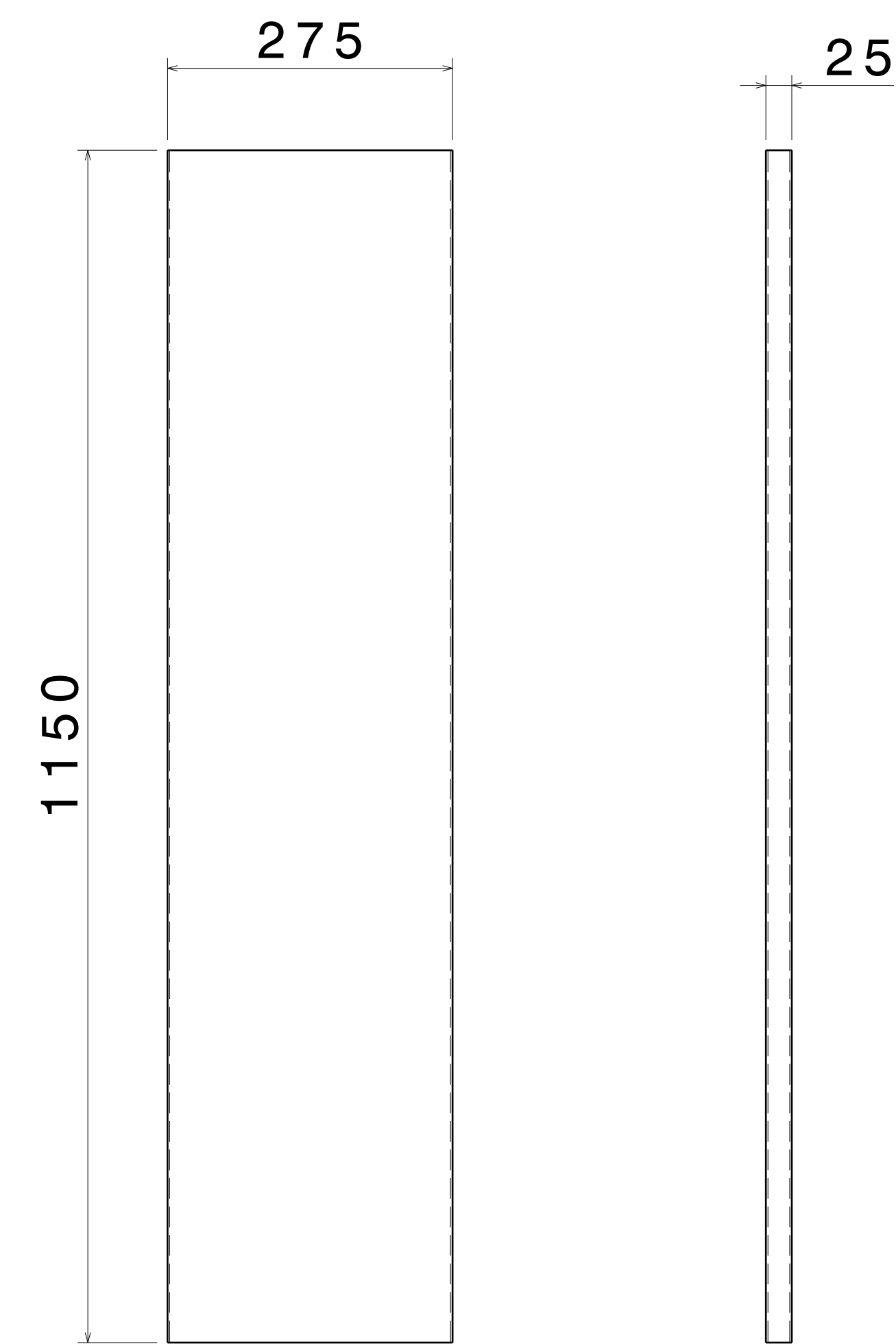

FRONT VIEW
SCALE: 1:5

RIGHT VIEW
SCALE: 1:5

ITEM 3, RHS PLANK 3
THICKNESS - 2.0MM

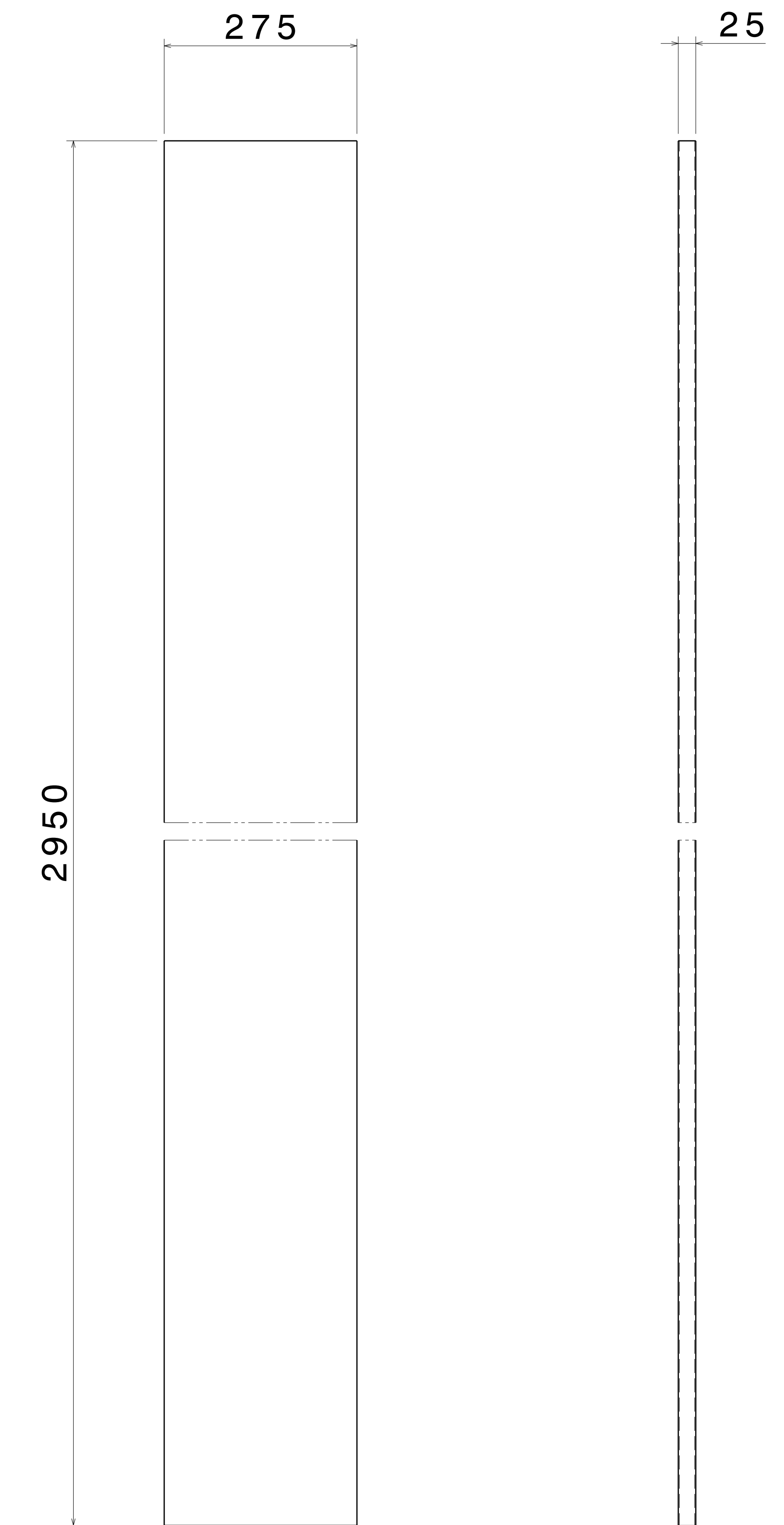

FRONT VIEW
SCALE: 1:5

RIGHT VIEW
SCALE: 1:5

ITEM 4, RHS PLANK 4
THICKNESS - 2.0MM

UNLESS OTHERWISE SPECIFIED DIMENSION ARE IN MM
VIEWS: THIRD ANGLE PROJECTION

This drawing is our property. It can't be reproduced or communicated without our written agreement.		APL APOLLO TUBES LTD.	
DRAWN BY SB		DATE 21SEPT2020	
CHECKED BY P2P Analysis & Solutions		DATE 21SEPT2020	
DESIGNED BY P2P Analysis & Solutions		DATE 21SEPT2020	
DRAWING TITLE SHELF 2		SIZE A0	DRAWING NUMBER P2P SHELF 2
SCALE NONE		WEIGHT (kg) XXX	REV 00
		SHEET 3 OF 3	