

REV	DATE	DESCRIPTION
00	24AUG2020	INITIAL REVISION

- NOTES:
- (⊥) ALL VERTICAL SUPPORTS ARE PERPENDICULAR.
 - FLATNESS OF .5MM IS APPLIED BY DEFAULT.
 - ⊥ WELD BEAD OF 2MM RADIUS IS FOLLOWED.
 - ▽ SURFACE FINISH MEDIUM TO SMOOTH IS USED.
 - ALL TUBES ARE AS PER APL APOLLO STANDARD. CHANGES MAY EFFECT THE LOAD CAPACITY.
 - ALL HORIZONTAL AND VERTICAL TUBES ARE PERPENDICULAR TO EACH OTHER WITH ±1 DEG.
 - FINE WELDING IS REQUIRED AS PER MENTIONED DETAILS AND FINISHING.
 - HIGHER CURRENT WELDING MAY AFFECT THE BRITTLENESS OF MATERIAL WHICH LATER MAY RAISE TO WEAKENING OF STRUCTURE.
 - FABRICATORS ARE ALLOWED TO USE FITTINGS/FRAMES/SUPPORTS AS NEEDED AND THE SAME MUST BE COMMUNICATED BACK TO ENGINEERING TEAM.
 - BOP COMPONENT WEIGHTS ARE FOR REFERENCE ONLY AND SUBJECTED TO CHANGE PER PURCHASED COMPONENTS.

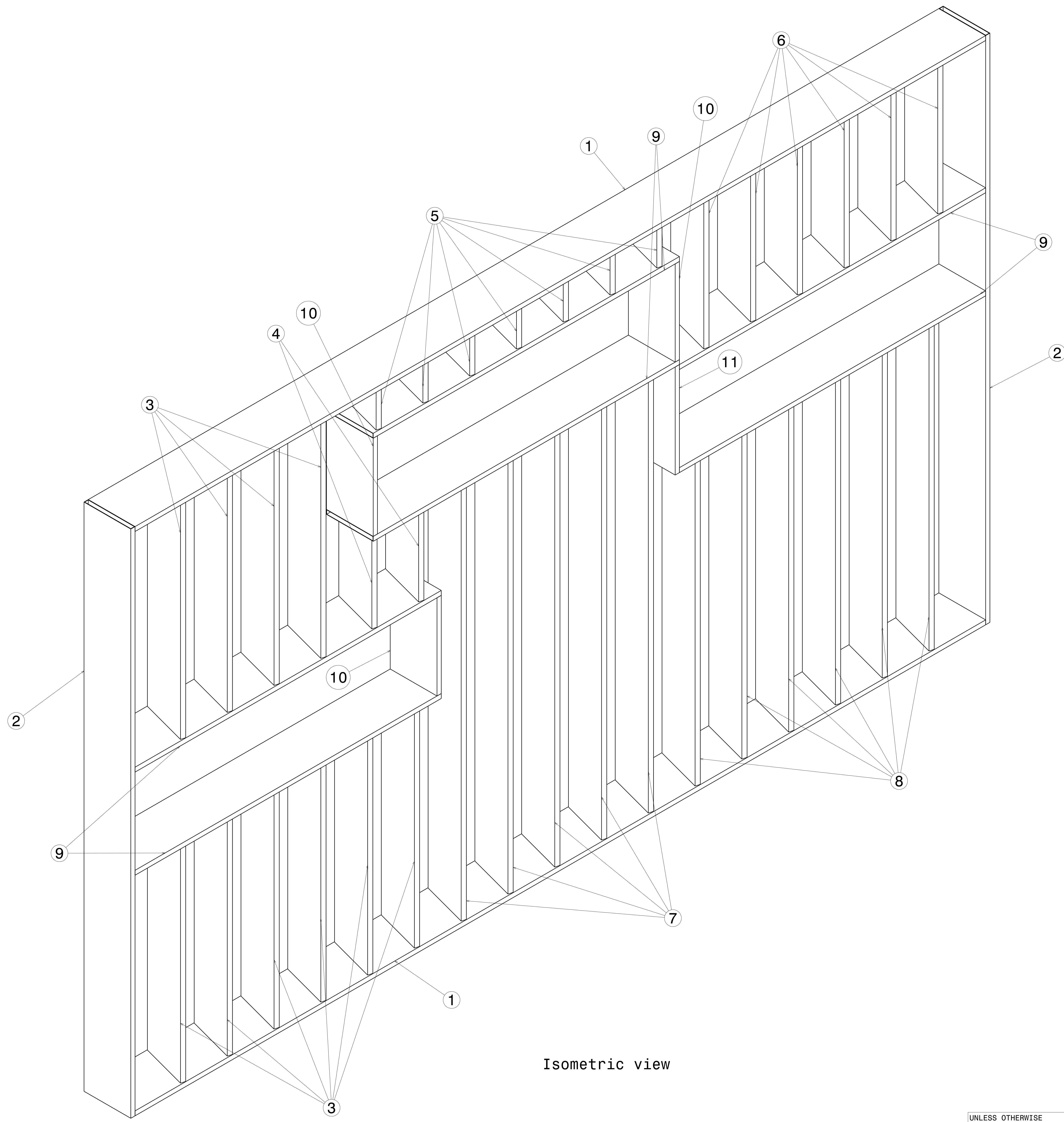

ITEM NO.	PART NUMBER	DESCRIPTION	QTY.	Wt (kg)/Each
11	Wall Partition 5 Plank 11	275 X 25 X 1.6 X 550	1	4.1
10	Wall Partition 5 Plank 10	275 X 25 X 1.6 X 500	3	3.73
9	Wall Partition 5 Plank 9	275 X 25 X 1.6 X 1800	6	13.44
8	Wall Partition 5 Plank 8	275 X 25 X 1.6 X 1650	6	12.32
7	Wall Partition 5 Plank 7	275 X 25 X 1.6 X 2200	5	16.42
6	Wall Partition 5 Plank 6	275 X 25 X 1.6 X 750	6	5.6
5	Wall Partition 5 Plank 5	275 X 25 X 1.6 X 200	7	1.5
4	Wall Partition 5 Plank 4	275 X 25 X 1.6 X 450	2	3.4
3	Wall Partition 5 Plank 3	275 X 25 X 1.6 X 1200	10	8.96
2	Wall Partition 5 Plank 2	275 X 25 X 2 X 3000	2	28
1	Wall Partition 5 Plank 1	275 X 25 X 2 X 5000	2	46.5

This drawing is our property. It can't be reproduced or communicated without our written agreement.

APL APOLLO TUBES LTD.

DRAWING TITLE: **Wall Partition 5**

DRAWN BY: SB	DATE: 24AUG2020	SIZE: A0	DRAWING NUMBER: P2P Wall Partition 5	REV: 00
CHECKED BY: P2P Analysis & Solutions	DATE: 24AUG2020	SCALE: As Indicated	WEIGHT(kg): 0kg	SHEET 1 OF 3
DESIGNED BY: P2P Analysis & Solutions	DATE: 24AUG2020			

UNLESS OTHERWISE SPECIFIED DIMENSION ARE IN MM
 VIEWS: THIRD ANGLE PROJECTION

REV	DATE	DESCRIPTION
00	24AUG2020	INITIAL REVISION

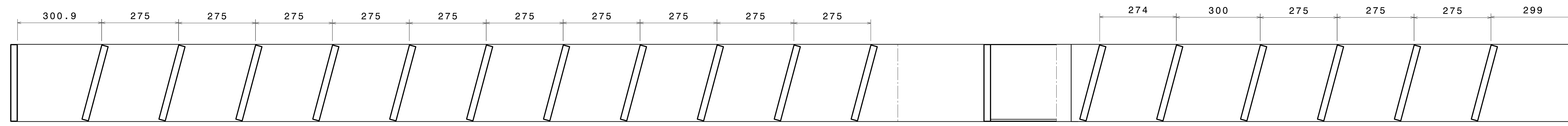

Section view B-B

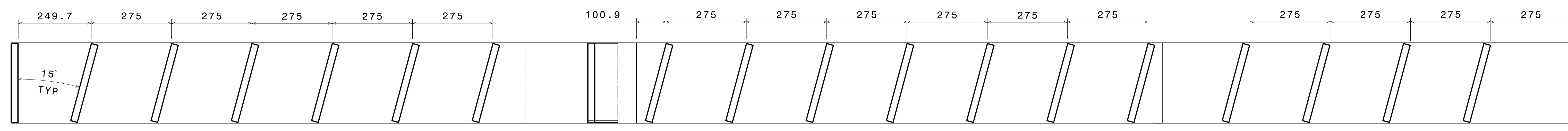

Section view A-A

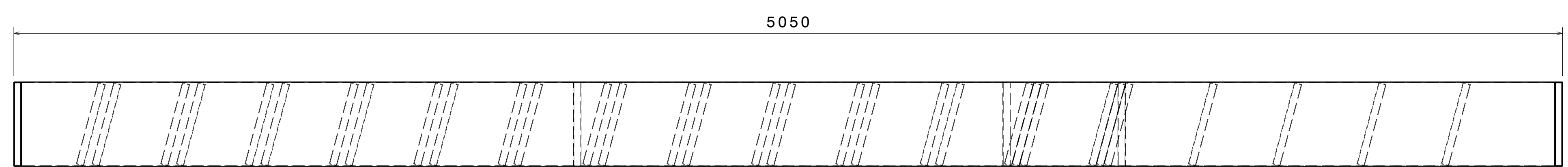

Top view

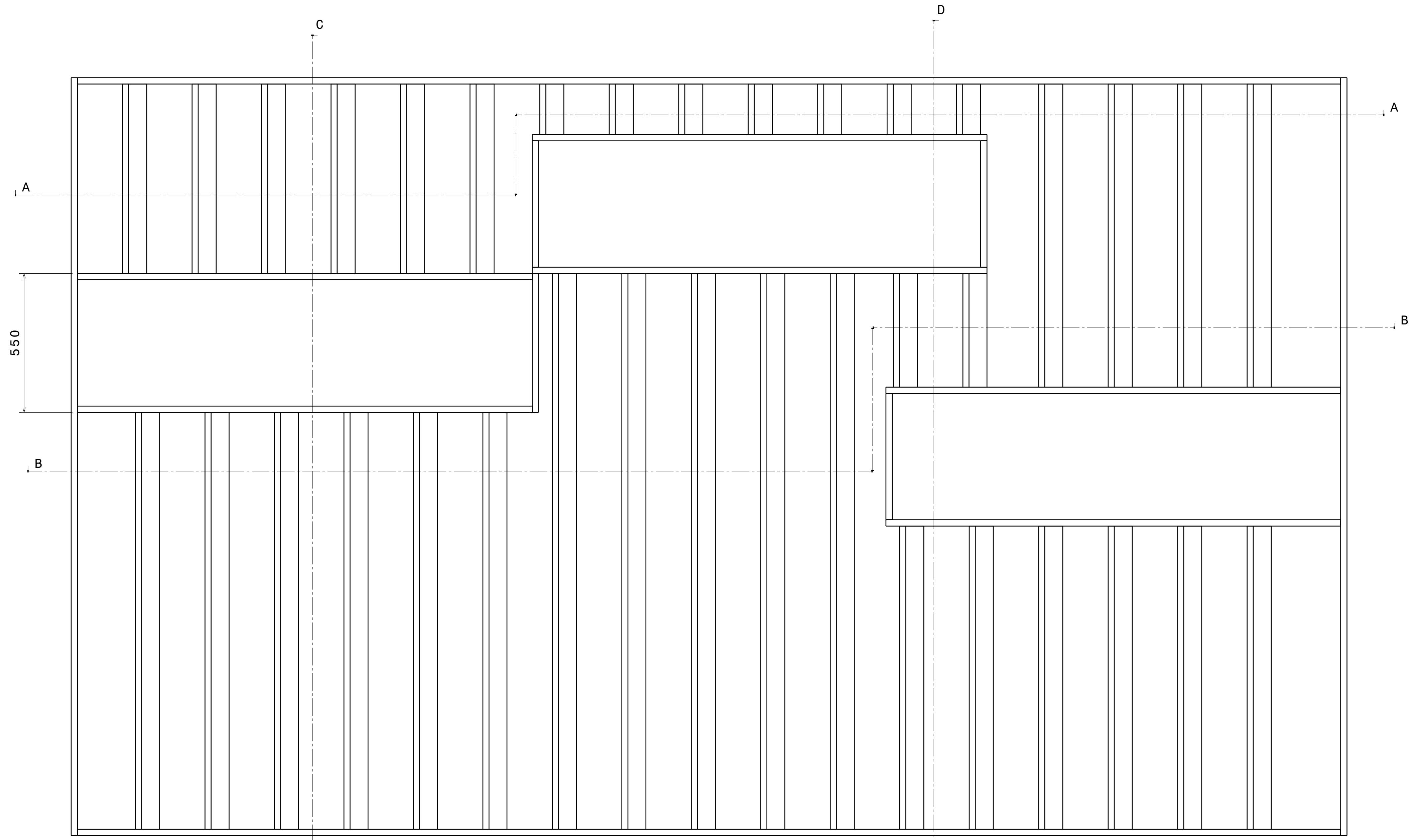

Front view

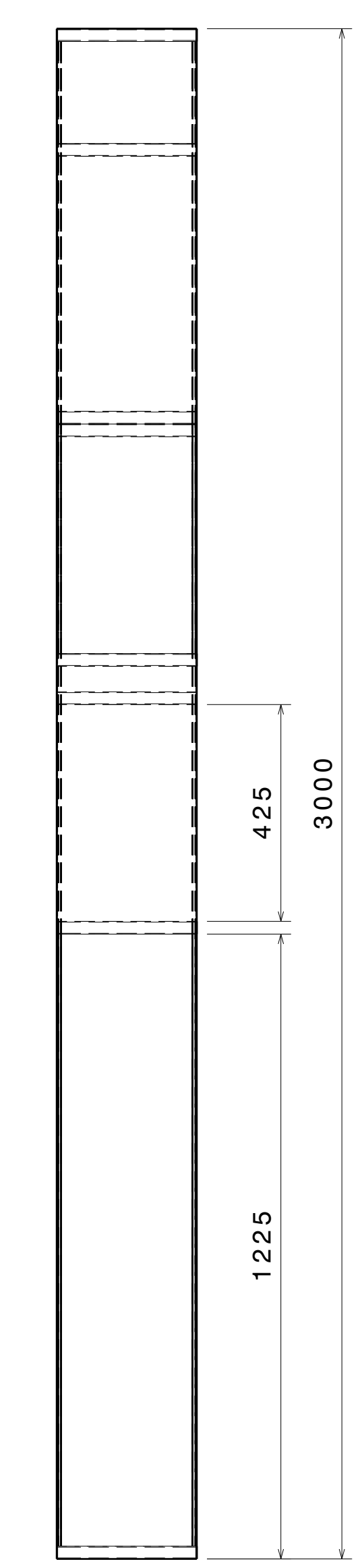

Right view

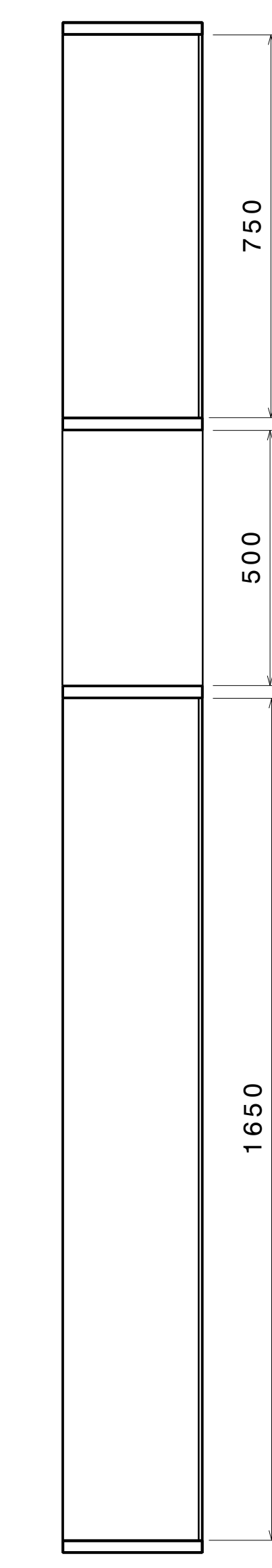

Section view C-C

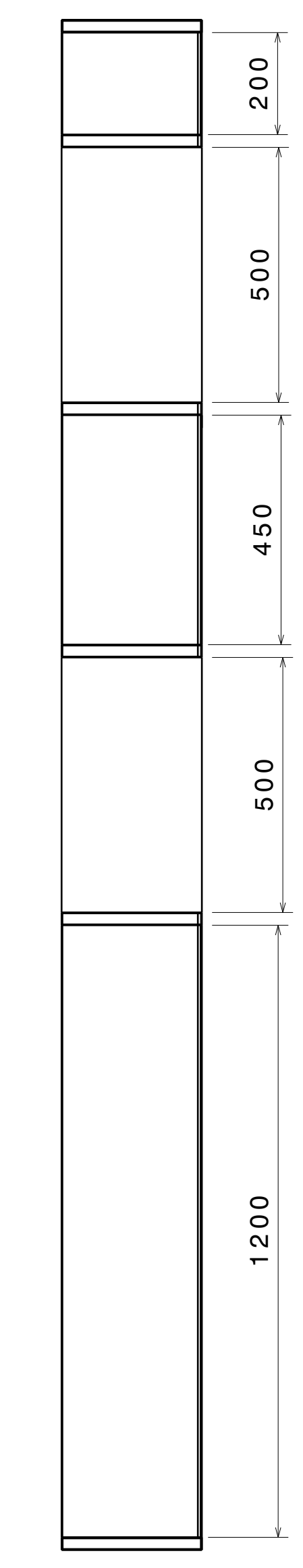

Section view D-D

This drawing is our property. It can't be reproduced or communicated without our written agreement.		APL APOLLO TUBES LTD. 	
DRAWN BY SB		DATE 24AUG2020	
CHECKED BY P2P Analysis & Solutions		DATE 24AUG2020	
DESIGNED BY P2P Analysis & Solutions		DATE 24AUG2020	
DRAWING TITLE Wall Partition 5		SIZE A0	DRAWING NUMBER P2P Wall Partition 5
SCALE NONE		WEIGHT (kg) XXX	REV 00
		SHEET 2 OF 3	

UNLESS OTHERWISE SPECIFIED DIMENSION ARE IN MM VIEWS: THIRD ANGLE PROJECTION

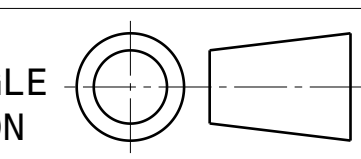

REV	DATE	DESCRIPTION
00	24AUG2020	INITIAL REVISION

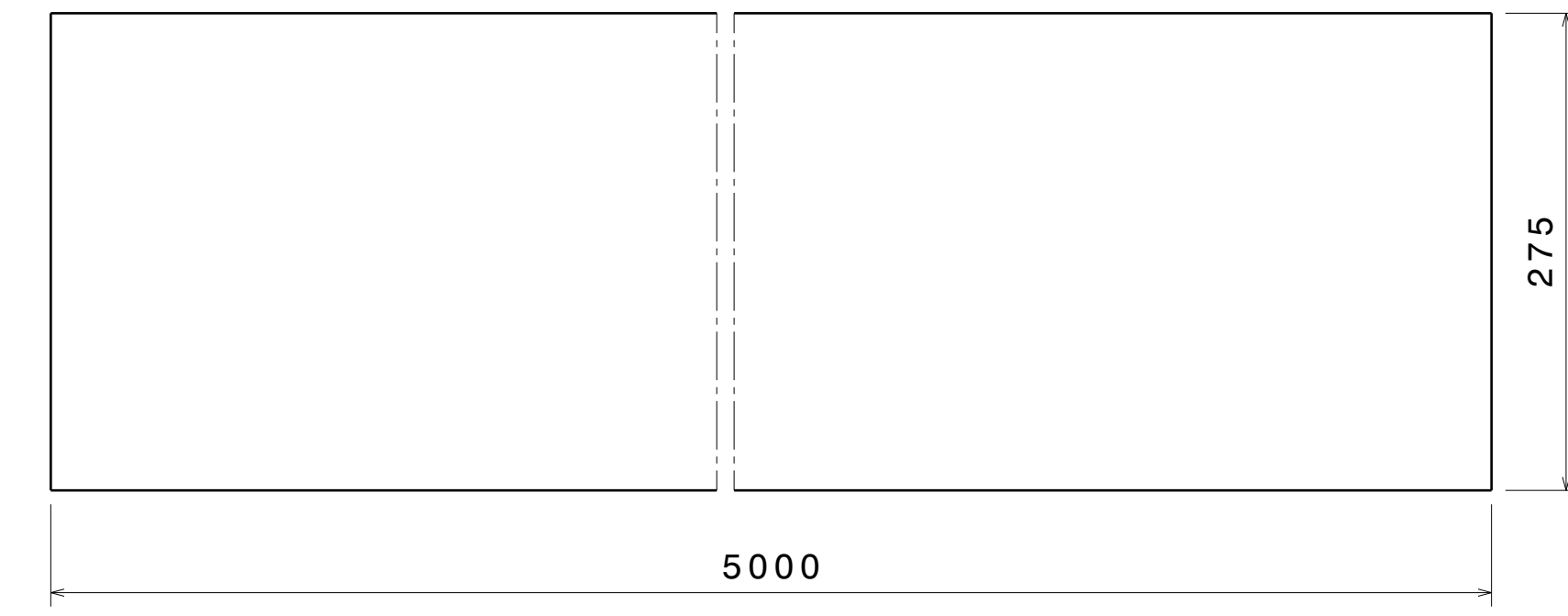

ITEM 1, PLANK 1

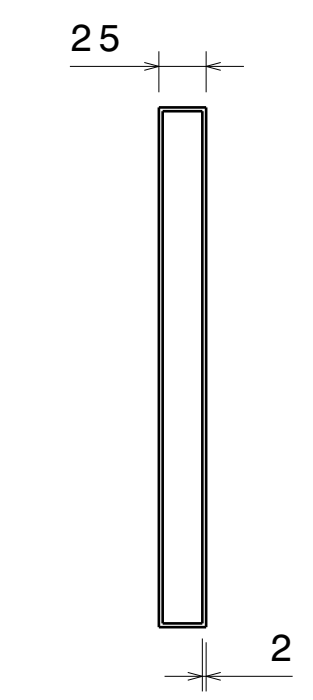

Right view
Scale: 1:4

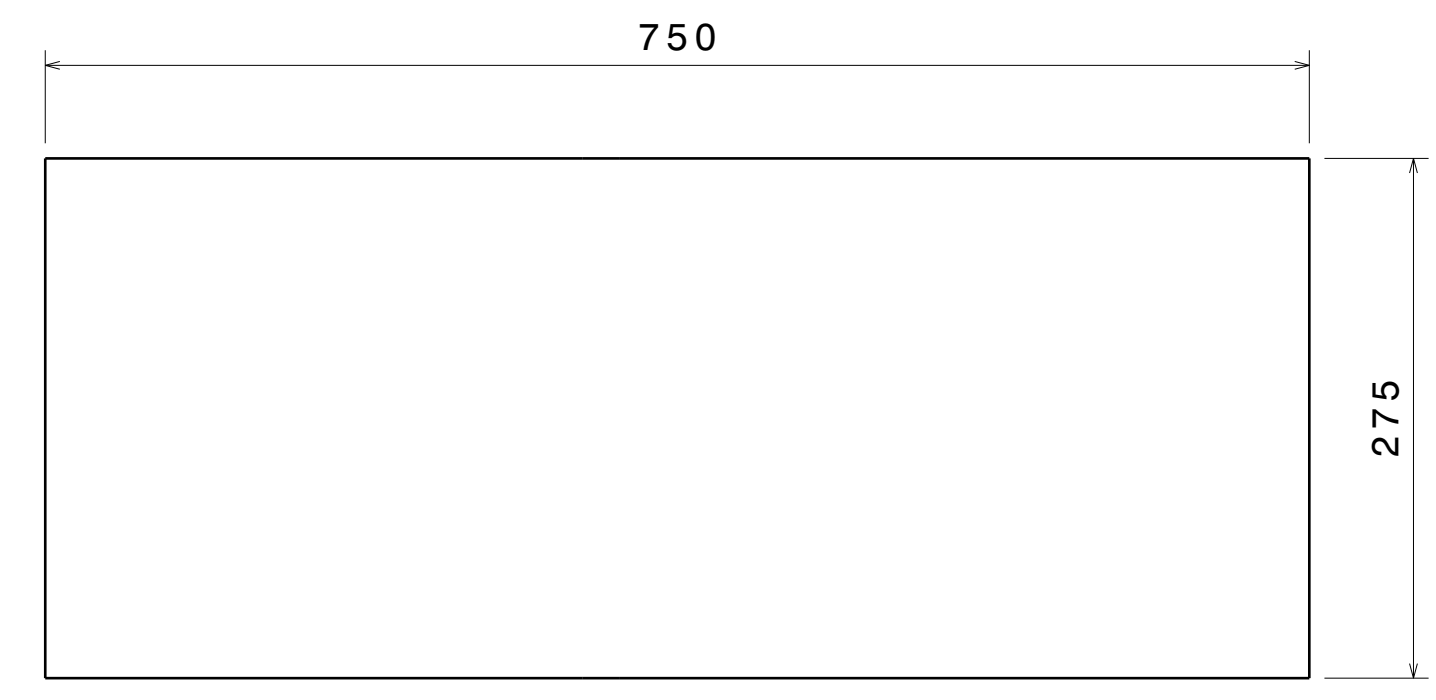

ITEM 6, PLANK 6

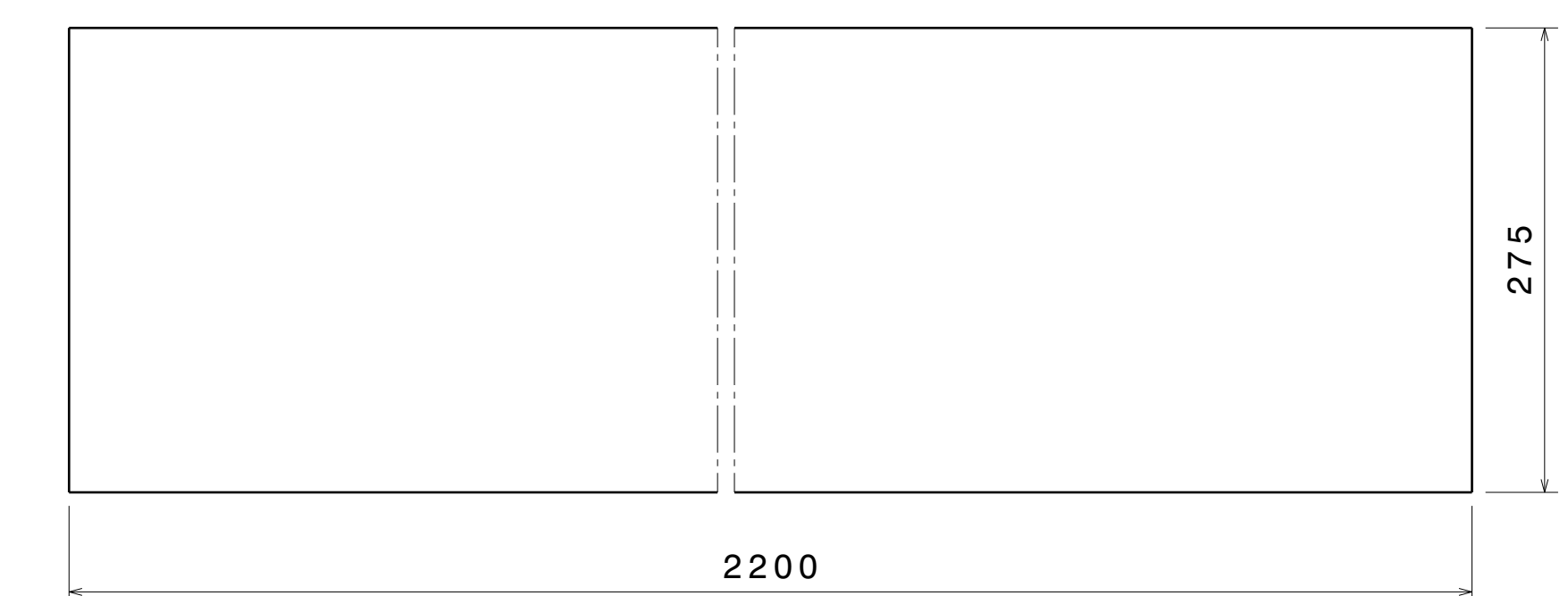

ITEM 7, PLANK 7

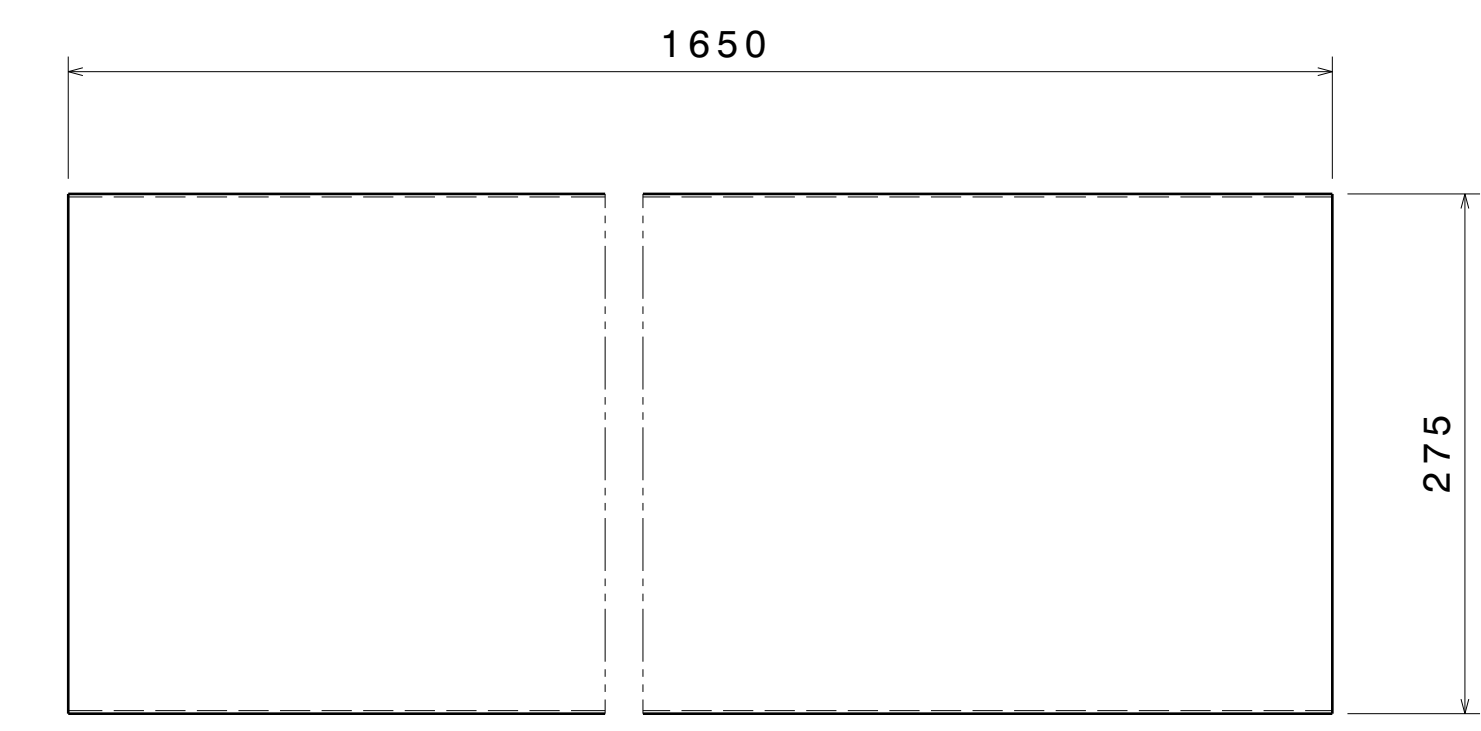

ITEM 8, PLANK 8

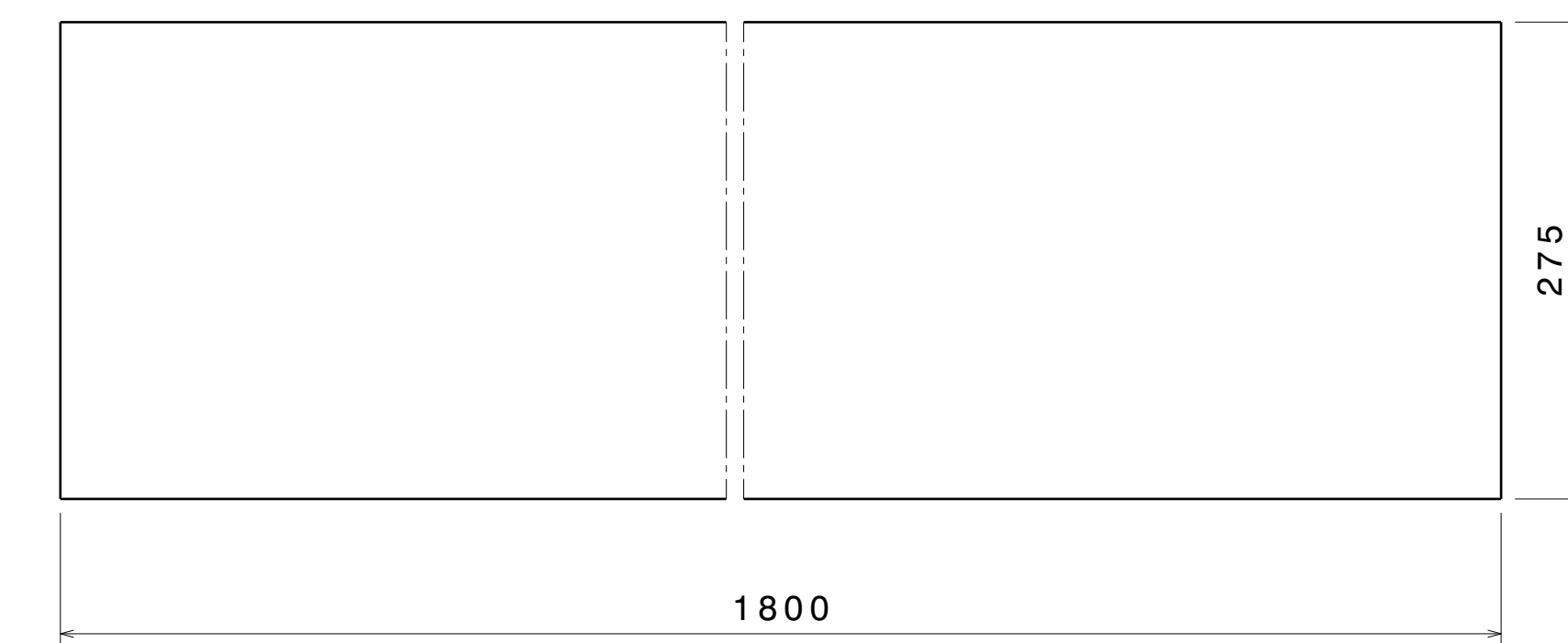

ITEM 9, PLANK 9

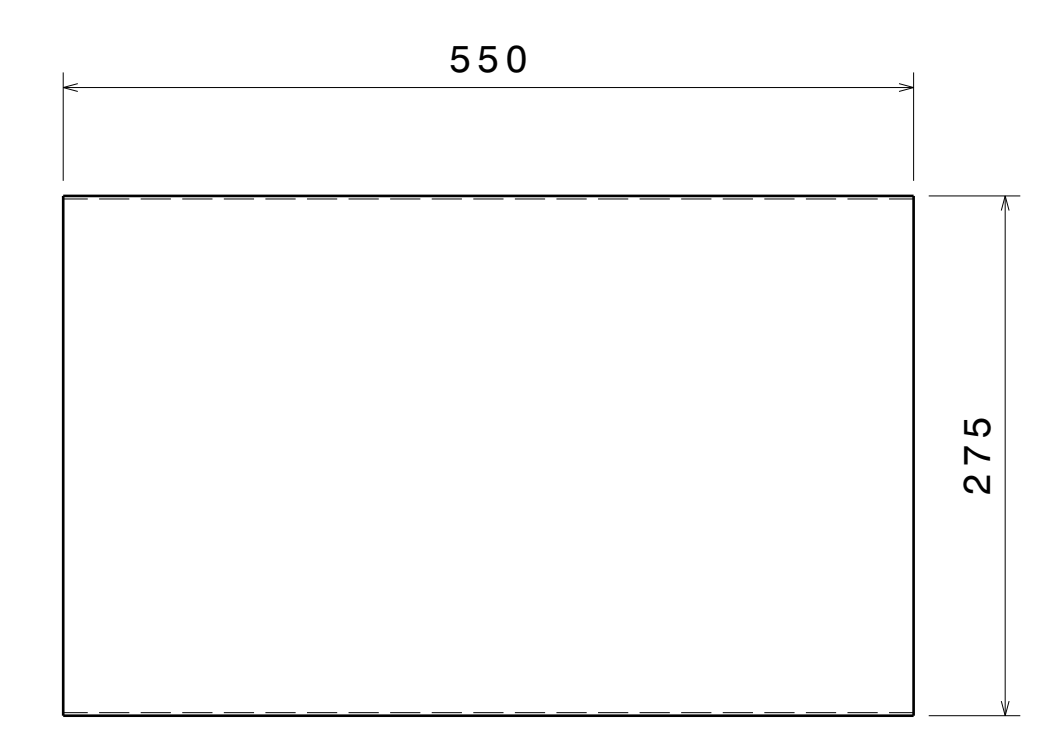

ITEM 11, PLANK 11

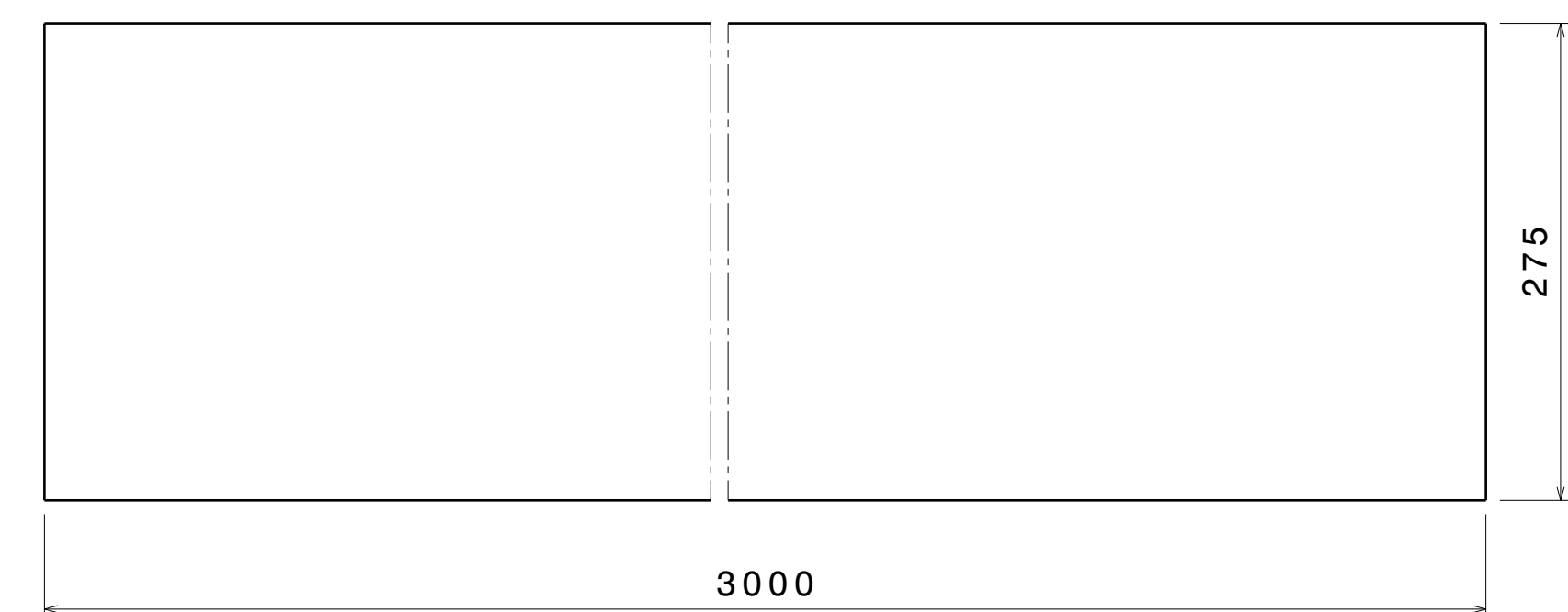

ITEM 2, PLANK 2

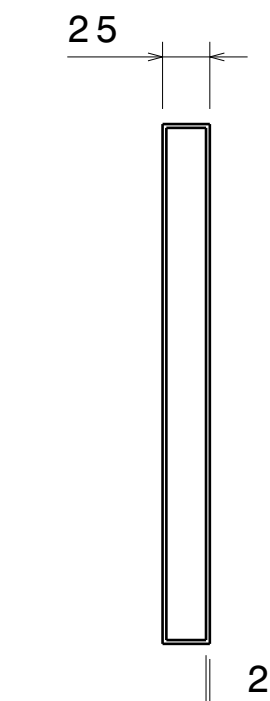

Right view[2]
Scale: 1:4

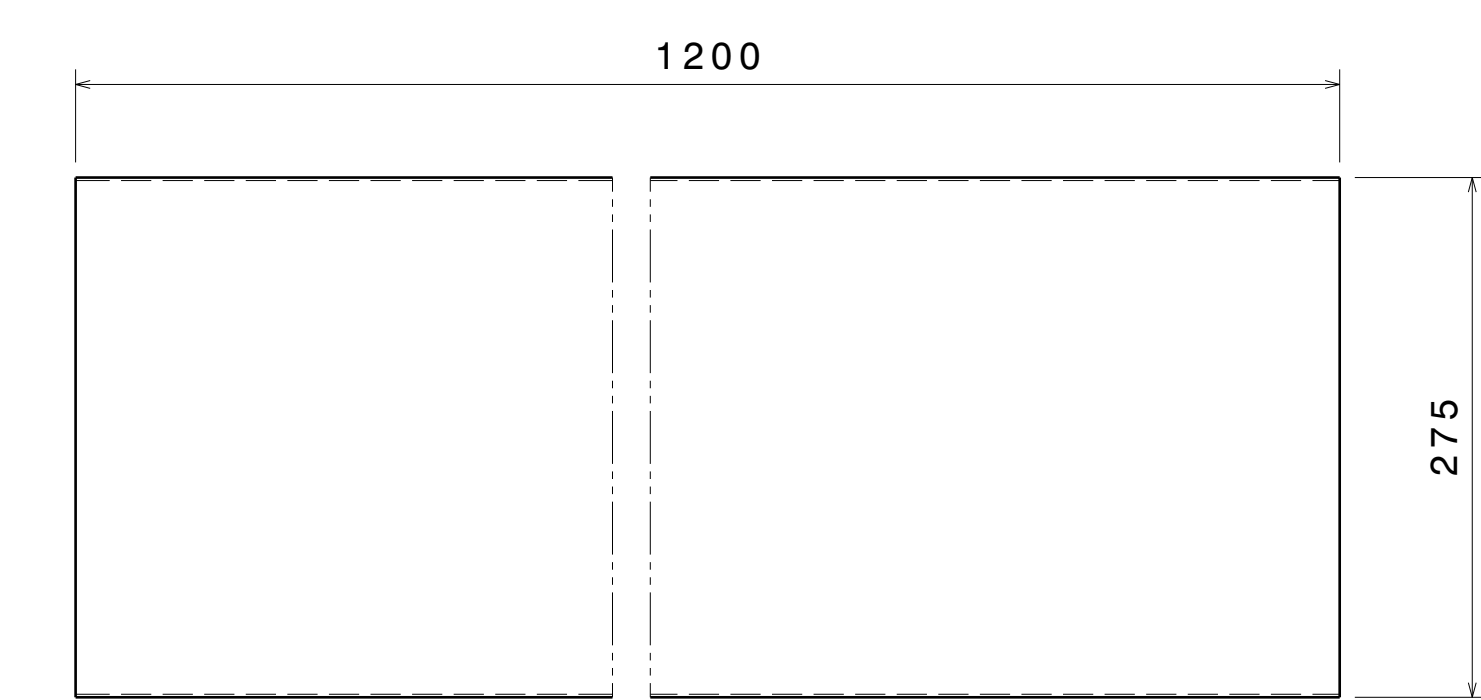

ITEM 3, PLANK 3

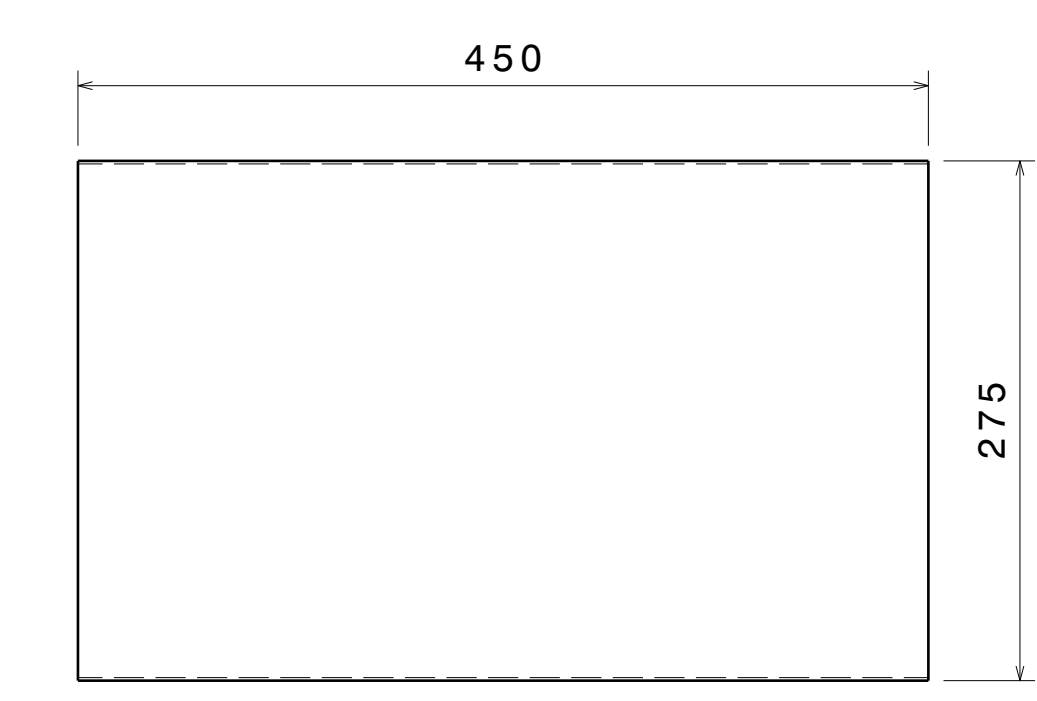

ITEM 4, PLANK 4

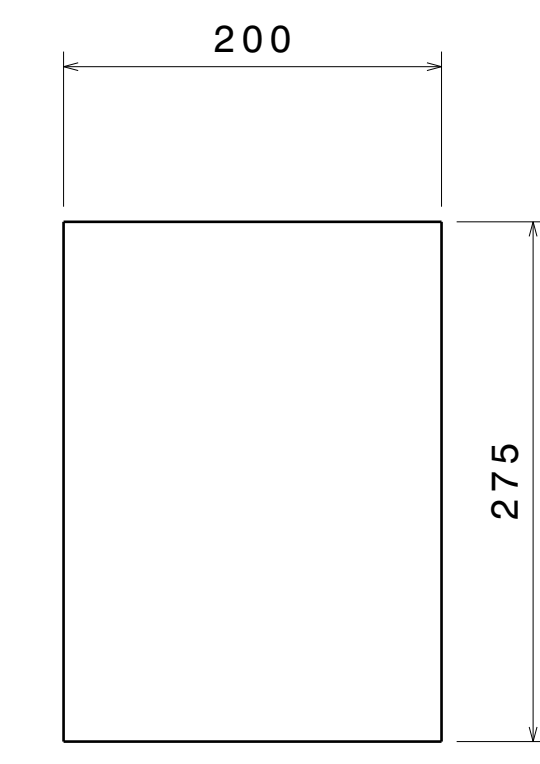

ITEM 5, PLANK 5

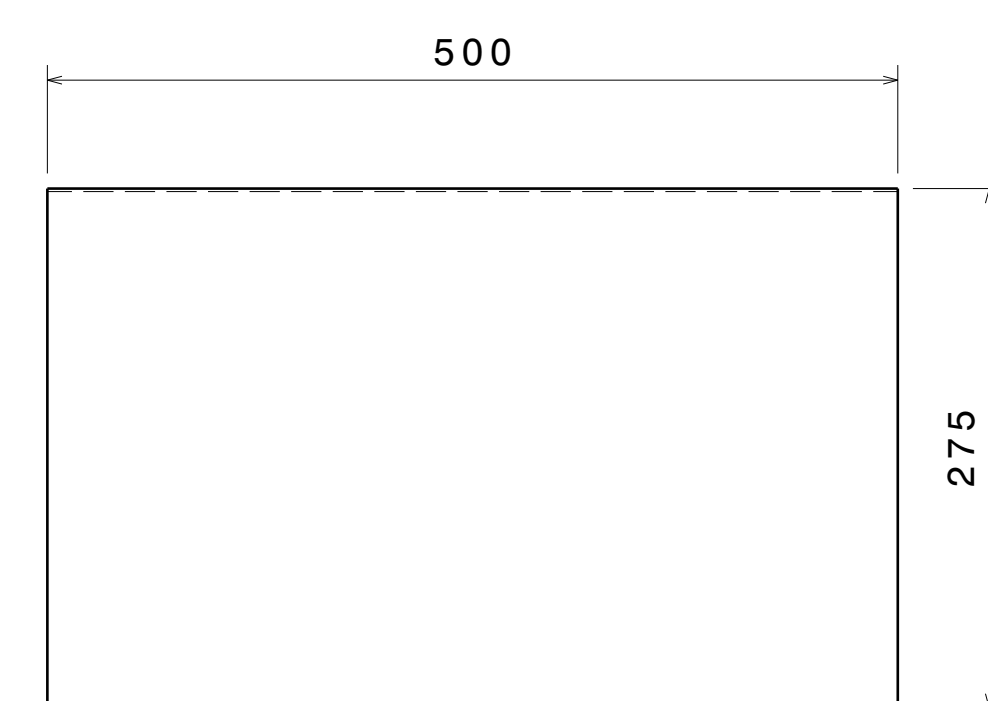

ITEM 10, PLANK 10

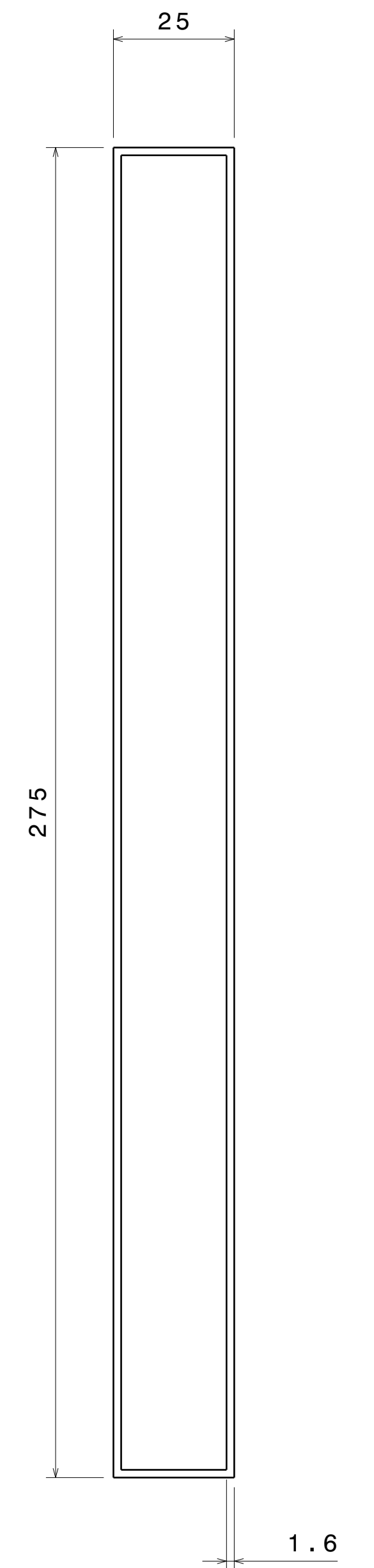

TYPICAL CROSS SECTION VIEW FOR
ITEMS 3, 4, 5, 6, 7, 8, 9, 10, 11

UNLESS OTHERWISE SPECIFIED DIMENSION ARE IN MM
VIEWS: THIRD ANGLE PROJECTION

This drawing is our property. It can't be reproduced or communicated without our written agreement.		APL APOLLO TUBES LTD.	
DRAWN BY SB		DATE 24AUG2020	
CHECKED BY P2P Analysis & Solutions		DATE 24AUG2020	
DESIGNED BY P2P Analysis & Solutions		DATE 24AUG2020	
SIZE A0	DRAWING NUMBER P2P Wall Partition 5	REV 00	
SCALE NONE	WEIGHT (kg) XXX	SHEET 3 OF 3	

DRAWING TITLE
Wall Partition 5