



INDIA'S
No. 1
STEEL PIPES BRAND

APOLLO
CHAUKHATTM
STEEL DOOR & WINDOW FRAMES



MADE BY ITALIAN TECHNOLOGY
FIRST TIME IN INDIA

*India's No. 1 by Market Share

ना लगेगी दीमक

ना लगेगा
फिटिंग में समय

ना रहेगा गैप

इंटैलियन
टेक्नोलोजी





INDIA'S FIRST STEEL CLOSED DOOR & WINDOW FRAMES

FOR EASY INSTALLATION & PROTECTION AGAINST TERMITES



Sudesh Group

Sudesh Group is India's leading steel pipes and tubes manufacturer with 13 plants across different locations in India. It's a pioneer in steel pipes and tubes of different types and shapes with a total manufacturing capacity of 2.5 million metric tons per annum. For over 3 decades, the group of companies has been revolutionizing the steel tubes and pipes manufacturing industry with its innovative and technology led processes to bring a paradigm shift, and has proven its market acumen.

Apollo Chaukhat is a shining example of our innovative spirit and our quest for introducing newer products and solutions which makes a difference in people's lives. Made with our revolutionary, and India's only



Direct Forming Technology (DFT), frames are lighter and available in customized size for an easier installation.





Traditionally, in India wooden frames are used for doors and windows. But as we have seen, these frames have several shortcomings. To start with, they are expensive, prone to termites and are inflammable. Moreover, installation is very time consuming and the look deteriorates with time.

But all this is about to change with Apollo's Chaukhat - India's first closed steel door and window frames. Frames can now be installed in just a few simple steps. Made of quality steel, you're assured of strength, durability, and quality without compromising on aesthetics. And, of course, termites don't stand a chance against the might of steel. What's more, with Apollo Chaukhat, you don't just save money but also precious trees.

So go ahead, make the perfect choice with Apollo Chaukhat.

THE PERFECT CHOICE FOR DOORS & WINDOWS



Fire-Resistant



Cost-Effective



Termite Proof



Durable



No Gaps
Made to Precision



Easy to fit



Eco Friendly



Recyclable



**STEEL VS WOOD
IT'S A "NO" MATCH**



PROPERTIES	WOOD	STEEL
Water & Moisture Proof	✗	✓
Termite & Pest Proof	✗	✓
No Shrinking & Swelling	✗	✓
Fire Retardant	✗	✓
Maintenance Free	✗	✓
Environment Friendly	✗	✓
Outdoor Adaptability	✗	✓
Gluing & Lamination	✗	✓
Weather & Ageing Resistant	✗	✓
High Screw & Nail Holding Capacity	✗	✓
Easy Sawing & Cutting	✗	✓
Solvent Based Joinery	✗	✓

FITS EASILY AND FASTER THAN WOODEN FRAMES

TWO STEP PROCESS

Another reason to choose Apollo Chaukhat is its quick installation process which is nothing short of magic. At the time of construction, as compared to wooden frames, which has to be fitted during construction, Apollo CHAUKHAT can be fitted post-construction in just two easy steps, like any modern PLUG & PLAY.

1 MEASUREMENT

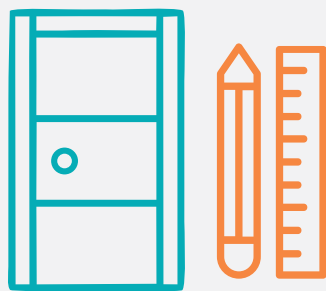

2 INSTALLATION

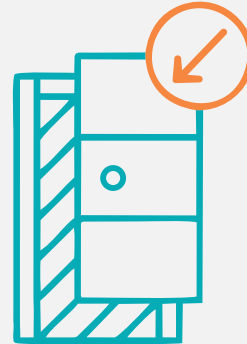

NO GAPS - FOR BUGS AND DUST

Installed with the help of concrete and cement, the open frames usually allow bugs and dust inside the house. These frames also fall behind on the grounds of beauty. Whereas, Apollo CHAUKHAT is a closed door frame which takes no time in installation, looks beautiful and shields the house from dust and bugs.

APOLLO CHAUKHAT

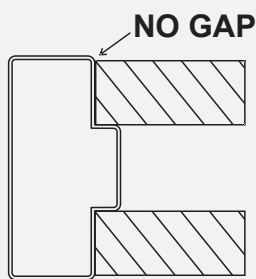

CONVENTIONAL DOOR FRAMES

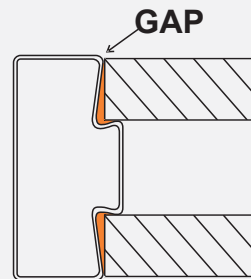

APOLLO CHAUKHAT

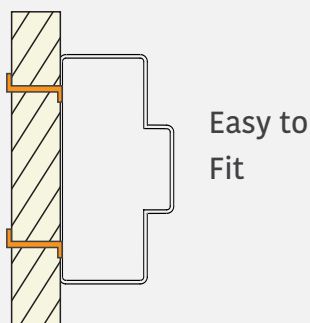

OTHER OPEN DOOR FRAME

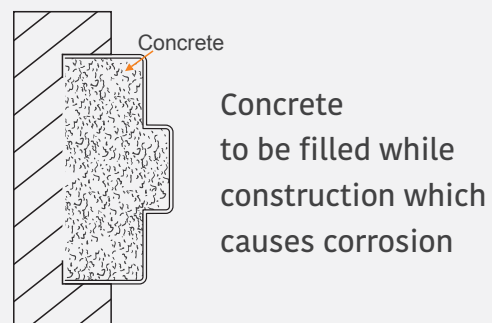

OUR WIDE RANGE OF DOOR AND WINDOW FRAMES

Door Frames

Apollo Chaukhat has a wide range of frames for doors. These cost-effective and easy to fit door and window frames are made up of quality steel and come in various sizes. For an aesthetic house, these door frames are the perfect choice.

Single Door Frames

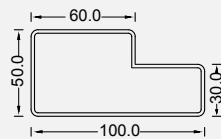

SINGLE DOOR FRAME - 100 x 50

Size

100 x 50 mm

Thickness

1.4 - 2.5 mm

Double Door Frames

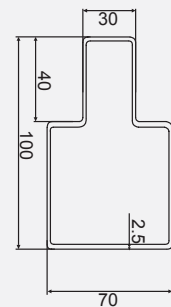
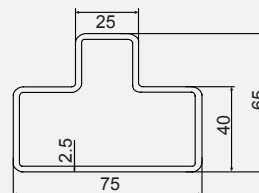
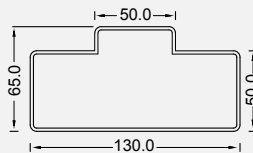

Size

130 x 65 mm
100 x 70 mm
75 x 65 mm

Thickness

1.4 - 2.5 mm

Double Side Door Frames

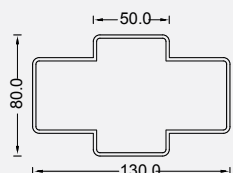
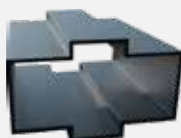

Size

130 x 80 mm

Thickness

1.4 - 2.5 mm

Window Frames

Apollo Chaukhat for windows have all the advantages of door frames. In addition, their compatibility is universal and can be installed in all types of windows. These lightweight window frames come in numerous sections that match to any type of aesthetic preference.

L Section

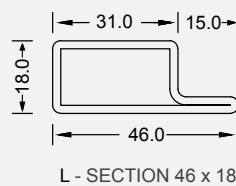

Size

46 x 18 mm
52 x 24 mm
62 x 33 mm

Thickness

1 - 2 mm

T Section

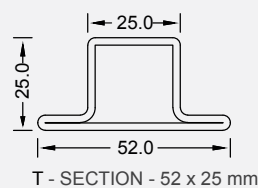

Size

52 x 25 mm

Thickness

1 - 2 mm

Z Section

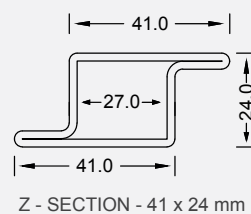

Size

41 x 24 mm

Thickness

1 - 2 mm



OUR NATIONWIDE PRESENCE

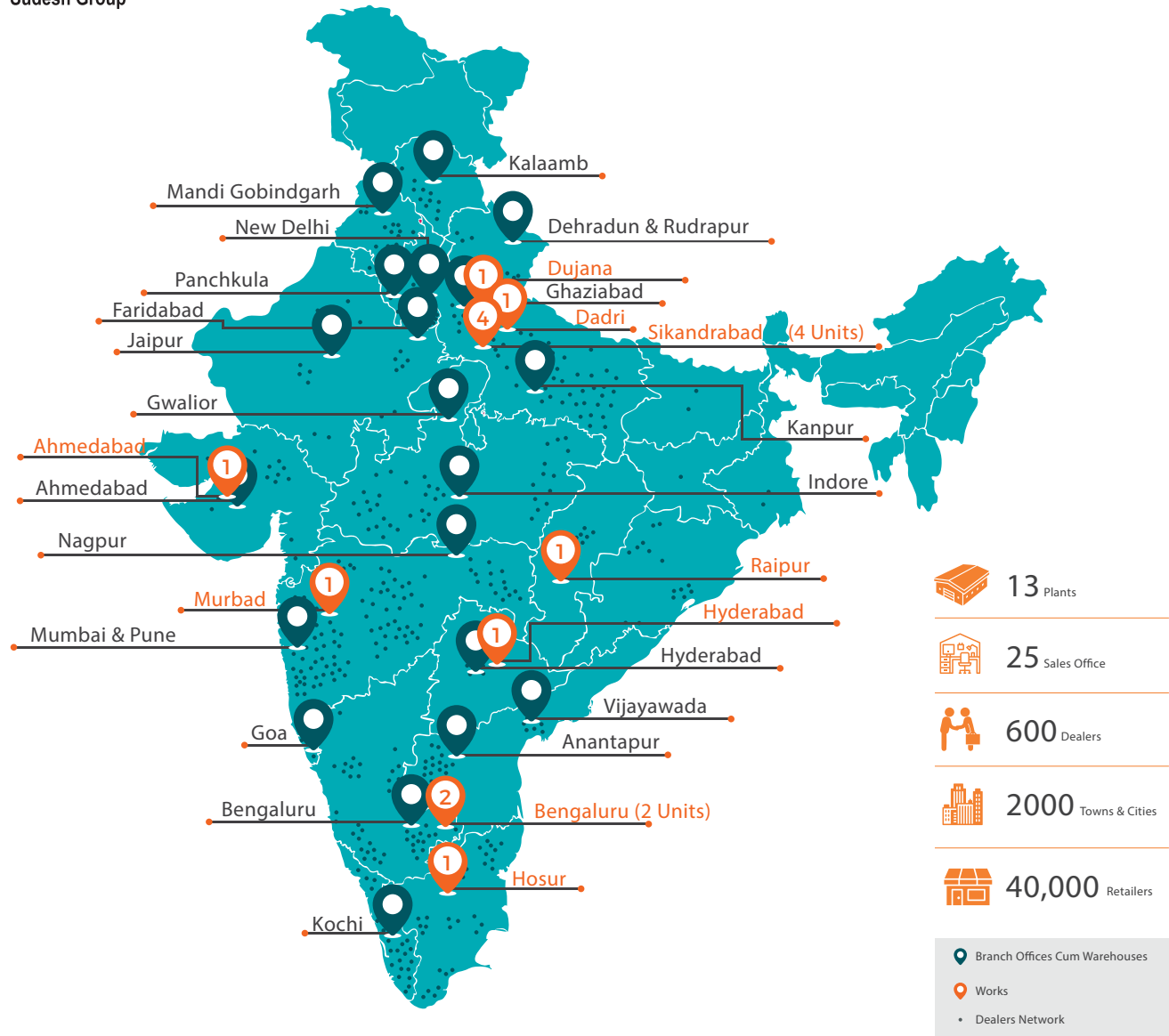

Apollo TriCoat™
 STEEL PIPES & DOOR FRAMES
 A Subsidiary of APL Apollo Company



Scan to know more about us

Head Office
 36, Kaushambi, Near Anand Vihar Terminal, Delhi (NCR) - 201010, India
 T : +91-120 4041400 F : +91-120 4041444

Follow us on : / APL APOLLO | TOLL FREE : 882 666 1273

www.aplapollo.com