

REV	DATE	DESCRIPTION
00	28JUL2020	INITIAL REVISION

- NOTES:
- (⊥) ALL VERTICAL SUPPORTS ARE PERPENDICULAR.
 - FLATNESS OF .5MM IS APPLIED BY DEFAULT.
 - ∩ WELD BEAD OF 2MM RADIUS IS FOLLOWED.
 - ▽ SURFACE FINISH MEDIUM TO SMOOTH IS USED.
 - ALL TUBES ARE AS PER APL APOLLO STANDARD. CHANGES MAY EFFECT THE LOAD CAPACITY.
 - ALL HORIZONTAL AND VERTICAL TUBES ARE PERPENDICULAR TO EACH OTHER WITH ±1 DEG.
 - FINE WELDING IS REQUIRED AS PER MENTIONED DETAILS AND FINISHING.
 - HIGHER CURRENT WELDING MAY AFFECT THE BRITTLENESS OF MATERIAL WHICH LATER MAY RAISE TO WEAKENING OF STRUCTURE.
 - FABRICATORS ARE ALLOWED TO USE FITTINGS/FRAMES/SUPPORTS AS NEEDED AND THE SAME MUST BE COMMUNICATED BACK TO ENGINEERING TEAM.
 - BOP COMPONENT WEIGHTS ARE FOR REFERENCE ONLY AND SUBJECTED TO CHANGE PER PURCHASED COMPONENTS.

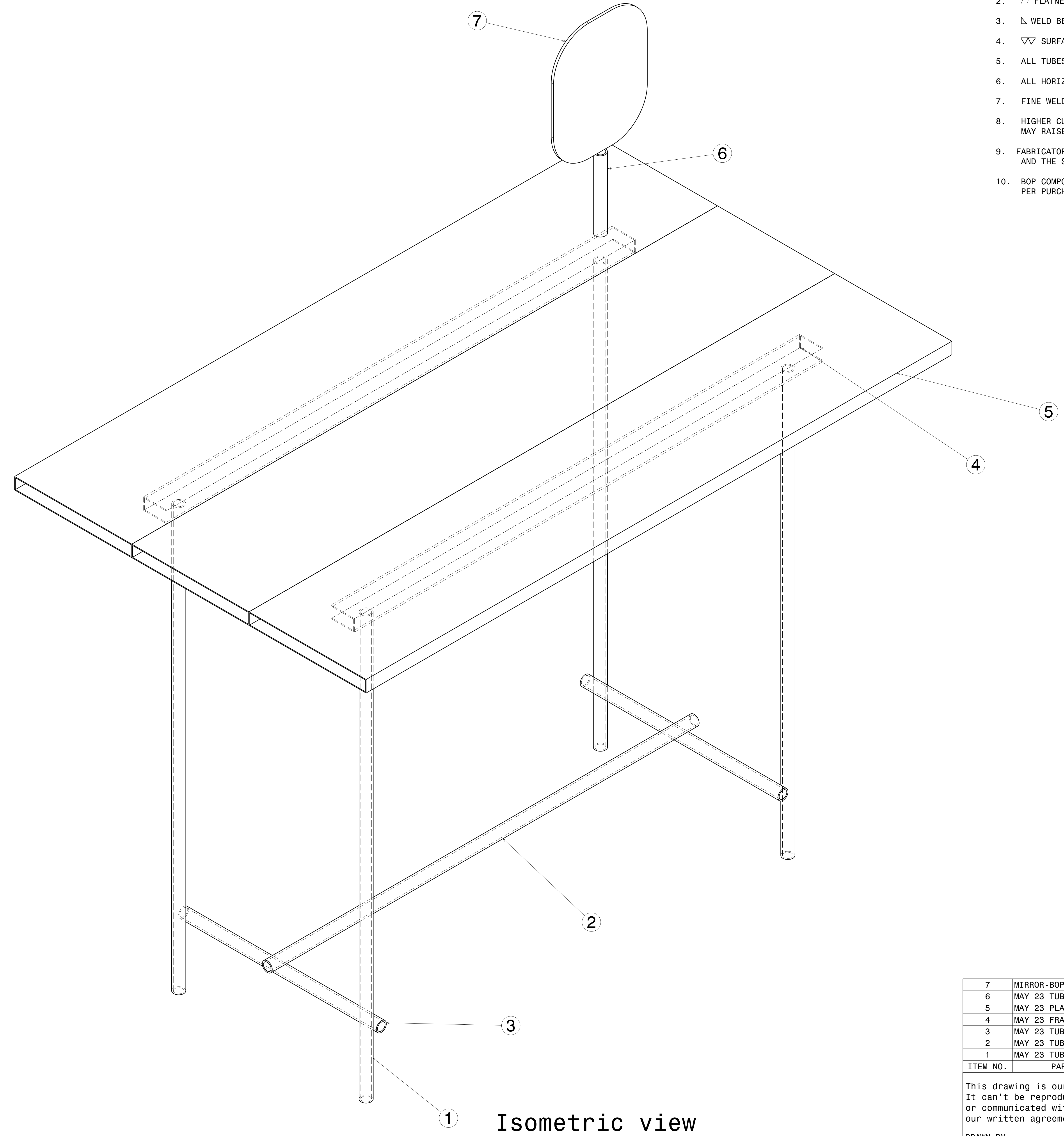

1 Isometric view

ITEM NO.	PART NUMBER	DESCRIPTION	QTY.	Wt (Kg)/Each
7	MIRROR-BOP	----	1	----
6	MAY 23 TUBE 4	DIA 21.4 X 2.6 X 150	1	0.18
5	MAY 23 PLANK	250 X 25 X 1.6 X 1250	3	8.55
4	MAY 23 FRAME 1	50 X 25 X 2.6 X 1000	2	2.25
3	MAY 23 TUBE 3	DIA 21.4 X 2.6 X 422	2	0.51
2	MAY 23 TUBE 2	DIA 21.4 X 2.6 X 911	1	1.1
1	MAY 23 TUBE 1	DIA 21.4 X 2.6 X 900	4	1.09

This drawing is our property. It can't be reproduced or communicated without our written agreement.		APL APOLLO TUBES LTD.	
DRAWN BY SB		DATE 28JUL2020	
CHECKED BY P2P Analysis & Solutions		DATE 28JUL2020	
DESIGNED BY P2P Analysis & Solutions		DATE 28JUL2020	
DRAWING TITLE MAY 23 GRESSING TABLE		SIZE A0	REV 00
SCALE As Indicated		WEIGHT(kg) 0kg	SHEET 1 OF 5

UNLESS OTHERWISE SPECIFIED DIMENSION ARE IN MM VIEWS: THIRD ANGLE PROJECTION

REV	DATE	DESCRIPTION
00	28JUL2020	INITIAL REVISION

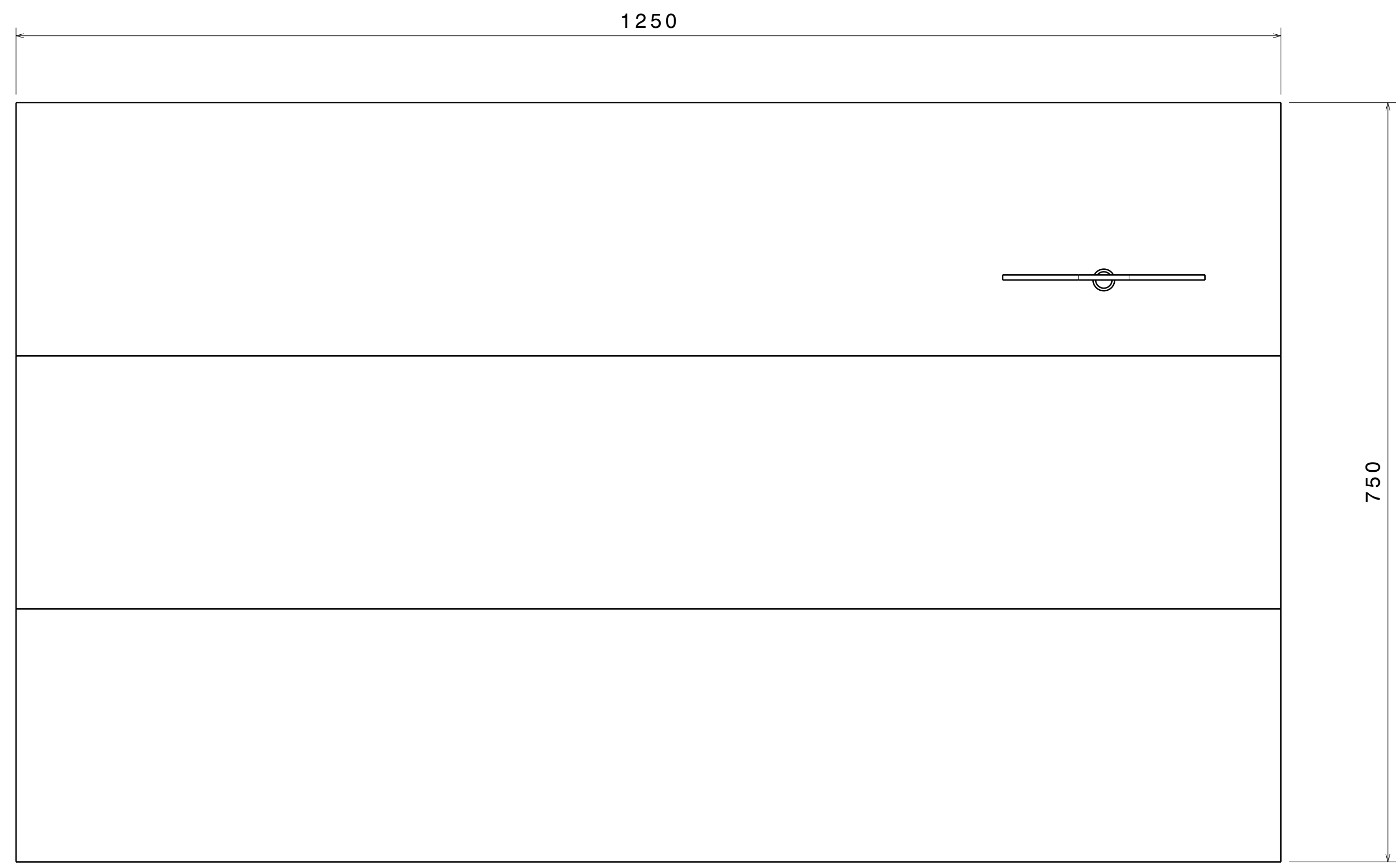

Top view
Scale: 1:4

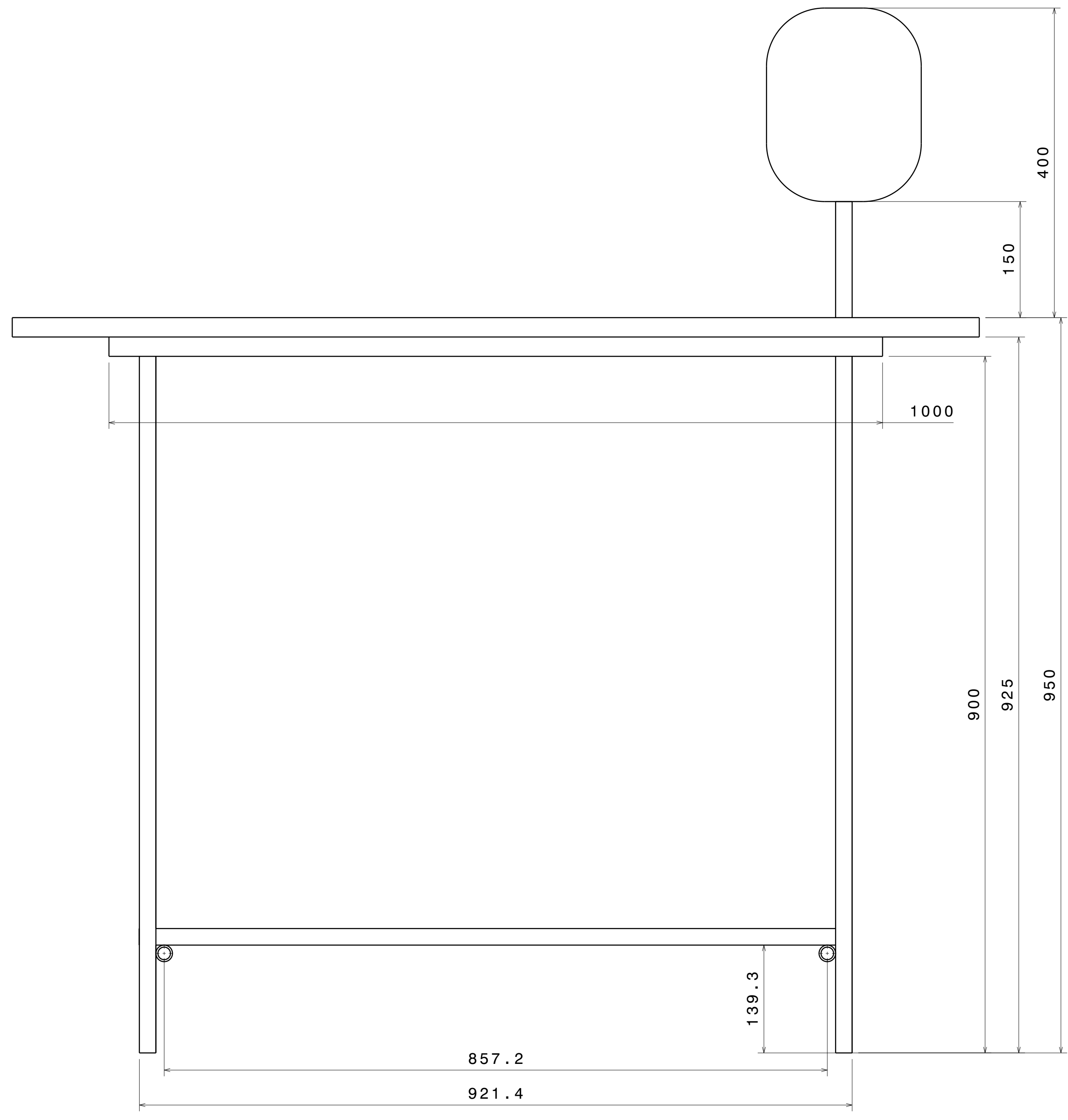

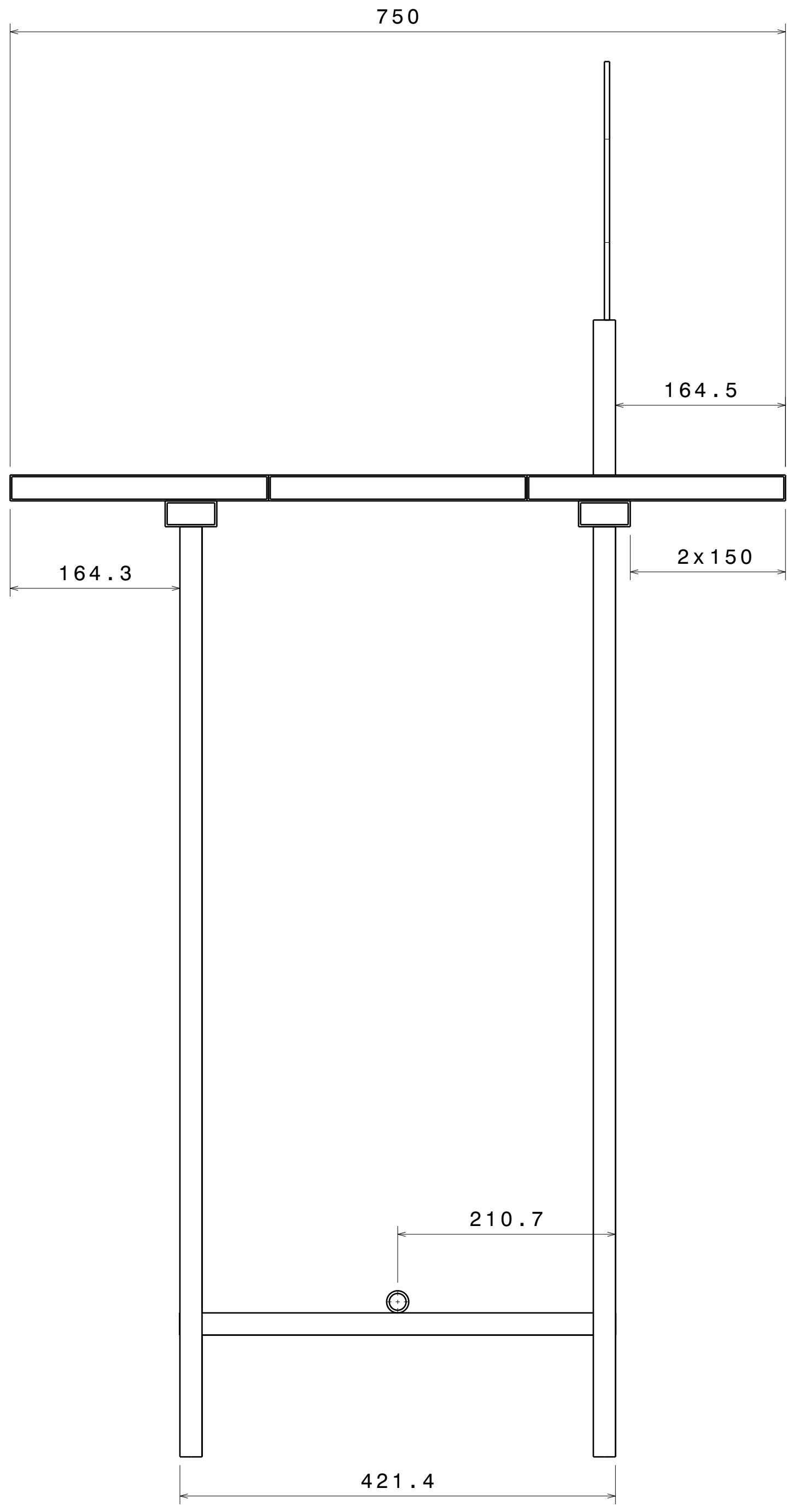

Front view
Scale: 1:4

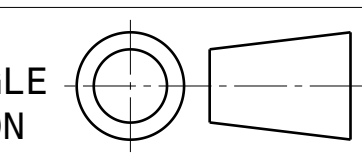

Right view
Scale: 1:4

UNLESS OTHERWISE SPECIFIED DIMENSION ARE IN MM
VIEWS: THIRD ANGLE PROJECTION



This drawing is our property. It can't be reproduced or communicated without our written agreement.		APL APOLLO TUBES LTD. 	
DRAWN BY SB		DATE 28JUL2020	
CHECKED BY P2P Analysis & Solutions		DATE 28JUL2020	
DESIGNED BY P2P Analysis & Solutions		DATE 28JUL2020	
SIZE A0	DRAWING NUMBER P2P MAY 23	REV 00	
SCALE NONE	WEIGHT (kg) XXX	SHEET 2 OF 5	

REV	DATE	DESCRIPTION
00	28JUL2020	INITIAL REVISION

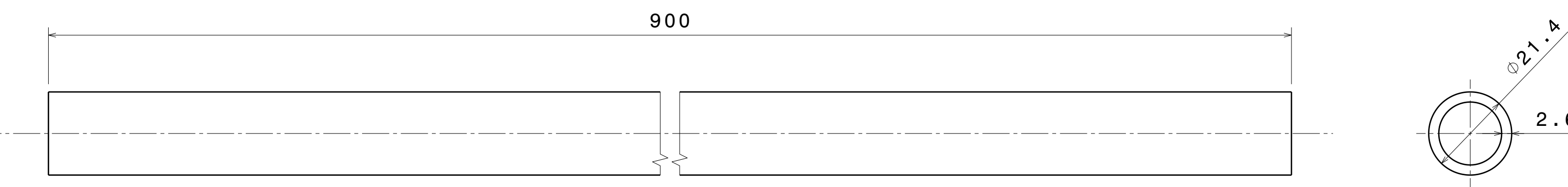

ITEM 1
FRONT VIEW

Right view
Scale: 1:1

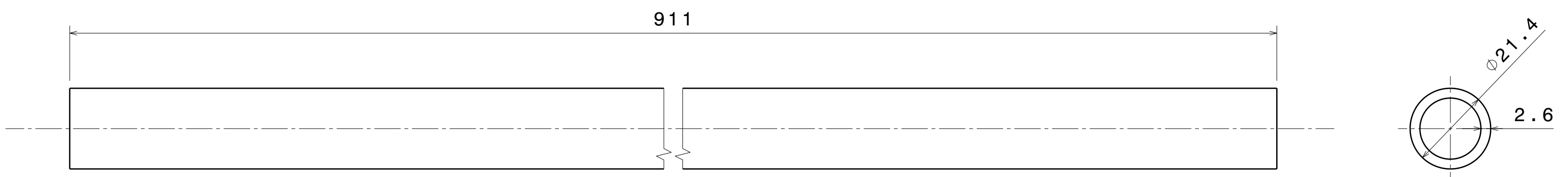

ITEM 2
FRONT VIEW

Right view[2]
Scale: 1:1

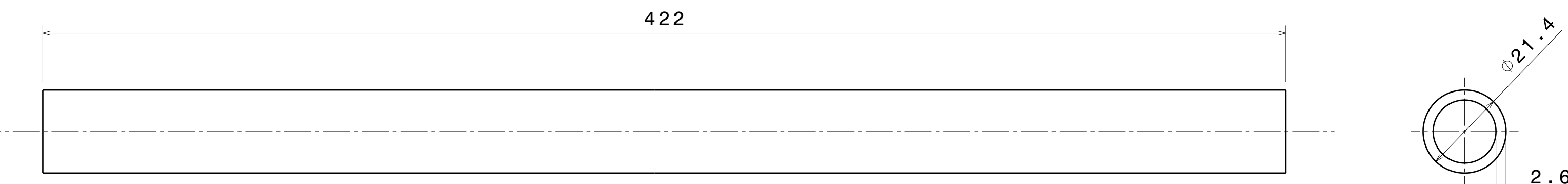

ITEM 3
FRONT VIEW

Right view[4]
Scale: 1:1

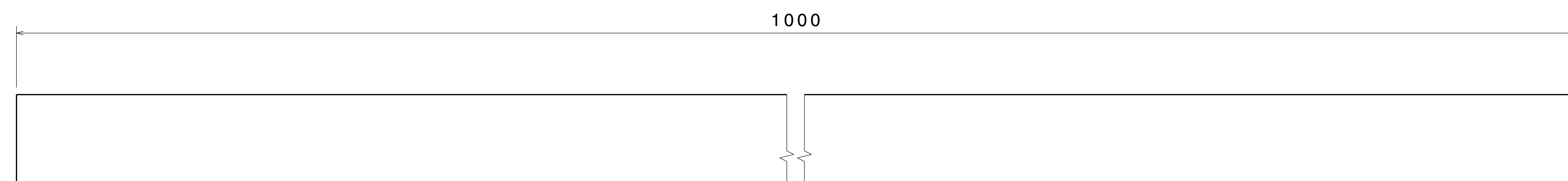

ITEM 4
FRONT VIEW

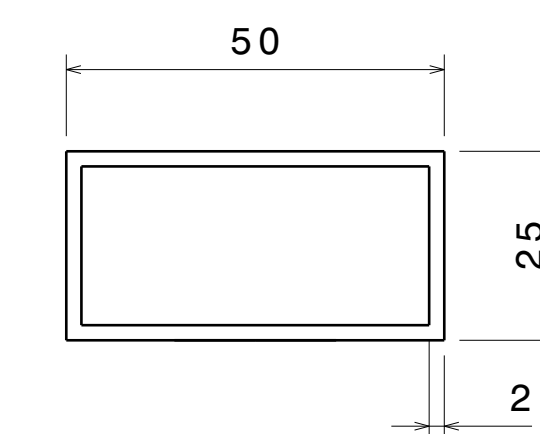

Right view
Scale: 1:1

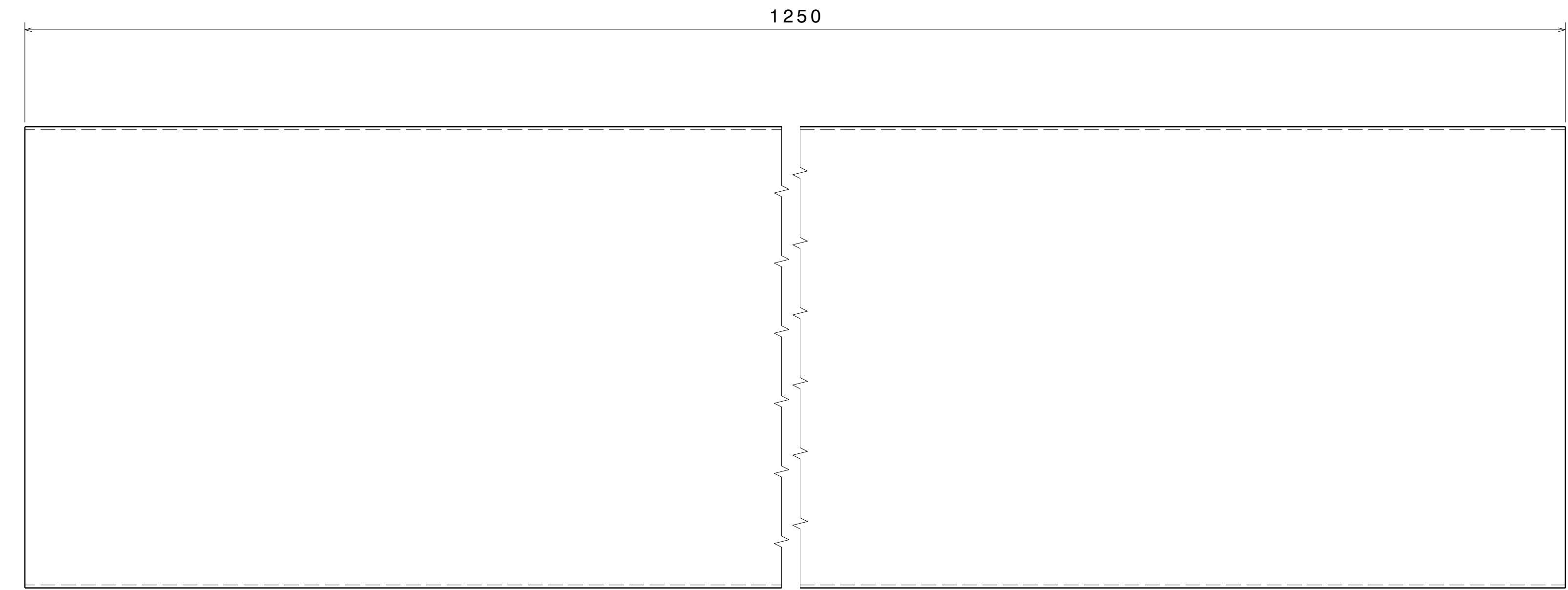

ITEM 5
FRONT VIEW

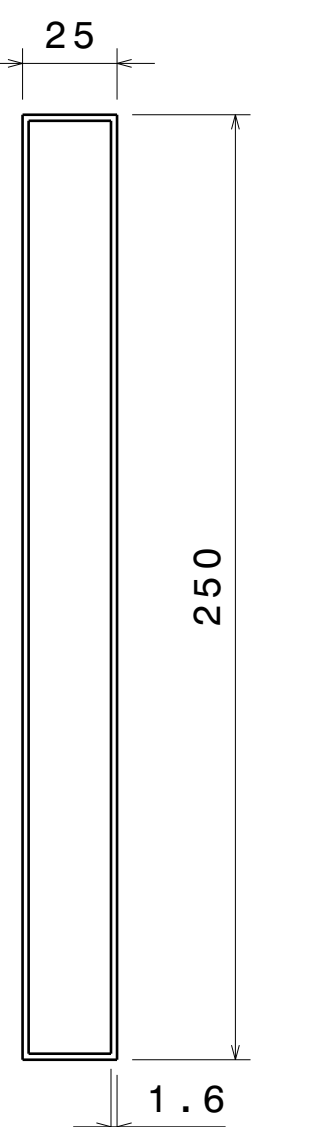

Right view
Scale: 1:2

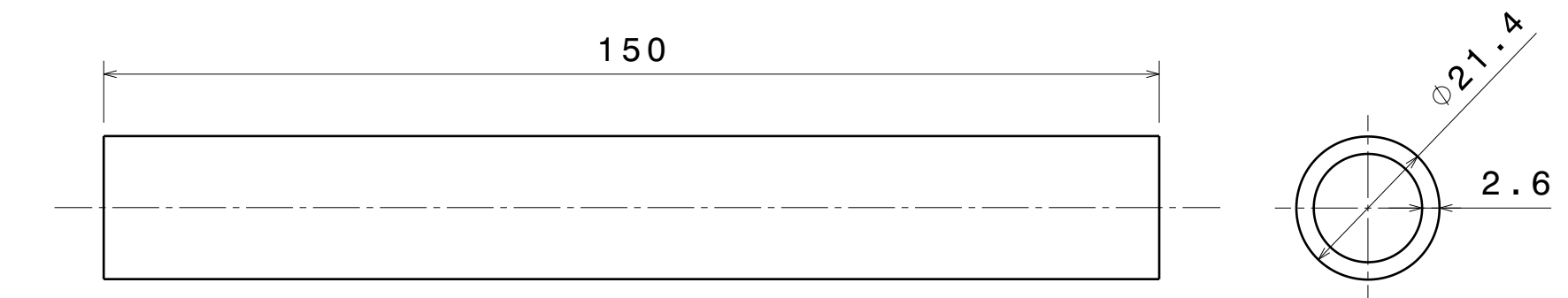

ITEM 6
FRONT VIEW

Right view[3]
Scale: 1:1

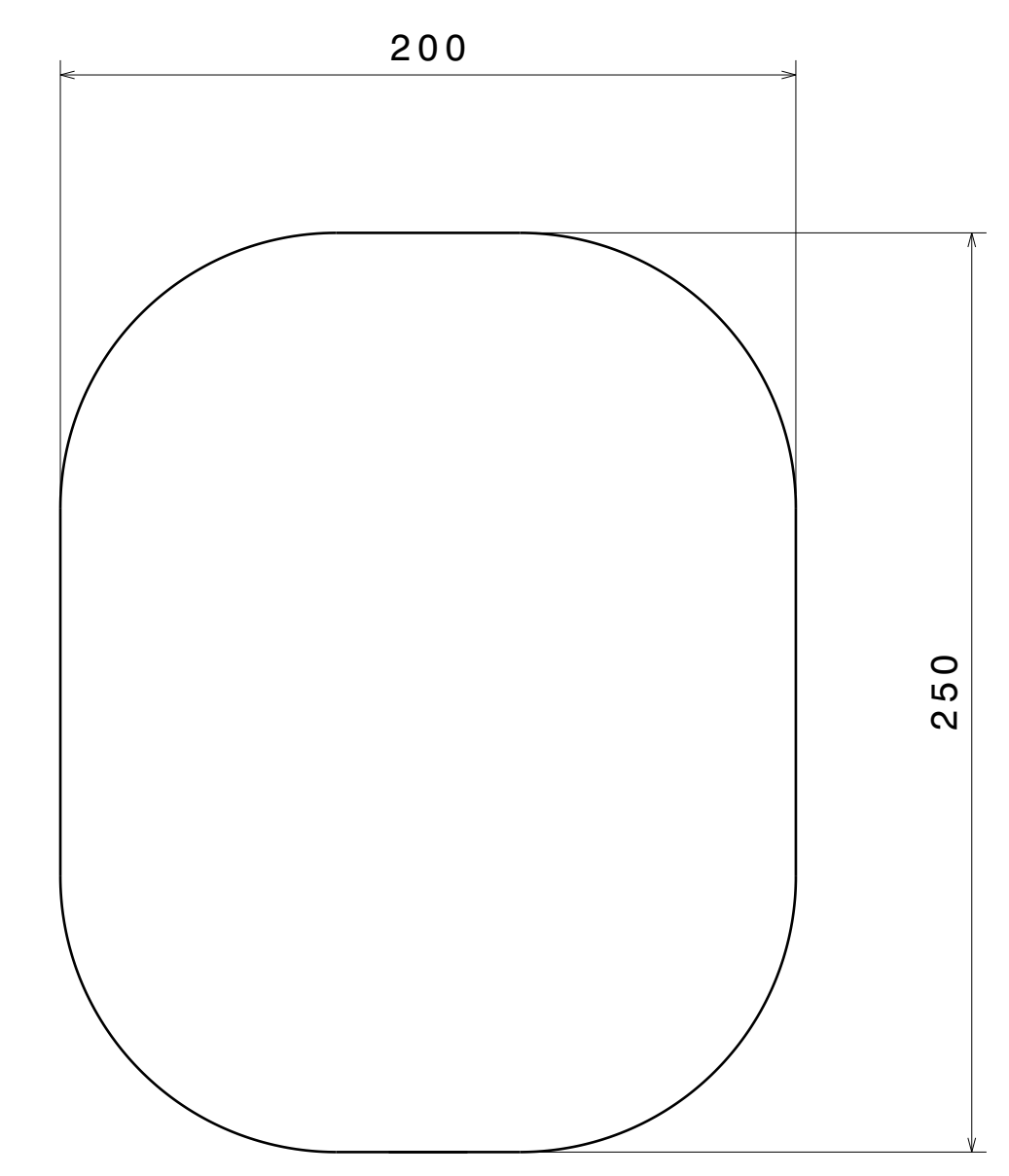

ITEM 7, MIRROR
VIEW IS FOR REFERENCE ONLY

UNLESS OTHERWISE SPECIFIED DIMENSION ARE IN MM VIEWS: THIRD ANGLE PROJECTION

This drawing is our property. It can't be reproduced or communicated without our written agreement.		APL APOLLO TUBES LTD.	
DRAWN BY SB		DATE 28JUL2020	
CHECKED BY P2P Analysis & Solutions		DATE 28JUL2020	
DESIGNED BY P2P Analysis & Solutions		DATE 28JUL2020	
DRAWING TITLE MAY 23 GRESSING TABLE		SIZE A0	DRAWING NUMBER P2P MAY 23
SCALE NONE		WEIGHT (kg) XXX	REV 00
			SHEET 3 OF 5