

REV	DATE	DESCRIPTION
00	17/04/2020	INITIAL REVISION

NOTES:

1. (⊥) ALL VERTICAL SUPPORTS ARE PERPENDICULAR.
2. □ FLATNESS OF .5MM IS APPLIED BY DEFAULT.
3. ∇ WELD BEAD OF 2MM RADIUS IS FOLLOWED.
4. ∇∇ SURFACE FINISH MEDIUM TO SMOOTH IS USED.
5. ALL TUBES ARE AS PER APL APOLLO STANDARD. CHANGES MAY EFFECT THE LOAD CAPACITY.
6. ALL HORIZONTAL AND VERTICAL TUBES ARE PERPENDICULAR TO EACH OTHER WITH ±1 DEG.
7. FINE WELDING IS REQUIRED AS PER MENTIONED DETAILS AND FINISHING.
8. HIGHER CURRENT WELDING MAY AFFECT THE BRITTLENESS OF MATERIAL WHICH LATER MAY RAISE TO WEAKENING OF STRUCTURE.
9. FABRICATORS ARE ALLOWED TO USE FITTINGS/FRAMES/SUPPORTS AS NEEDED AND THE SAME MUST BE COMMUNICATED BACK TO ENGINEERING TEAM.
10. LENGTH OF ALL LONGITUDINAL FRAMES ARE FOR REFERENCE ONLY AND SUBJECTED TO CHANGE PER REQUIREMENT.

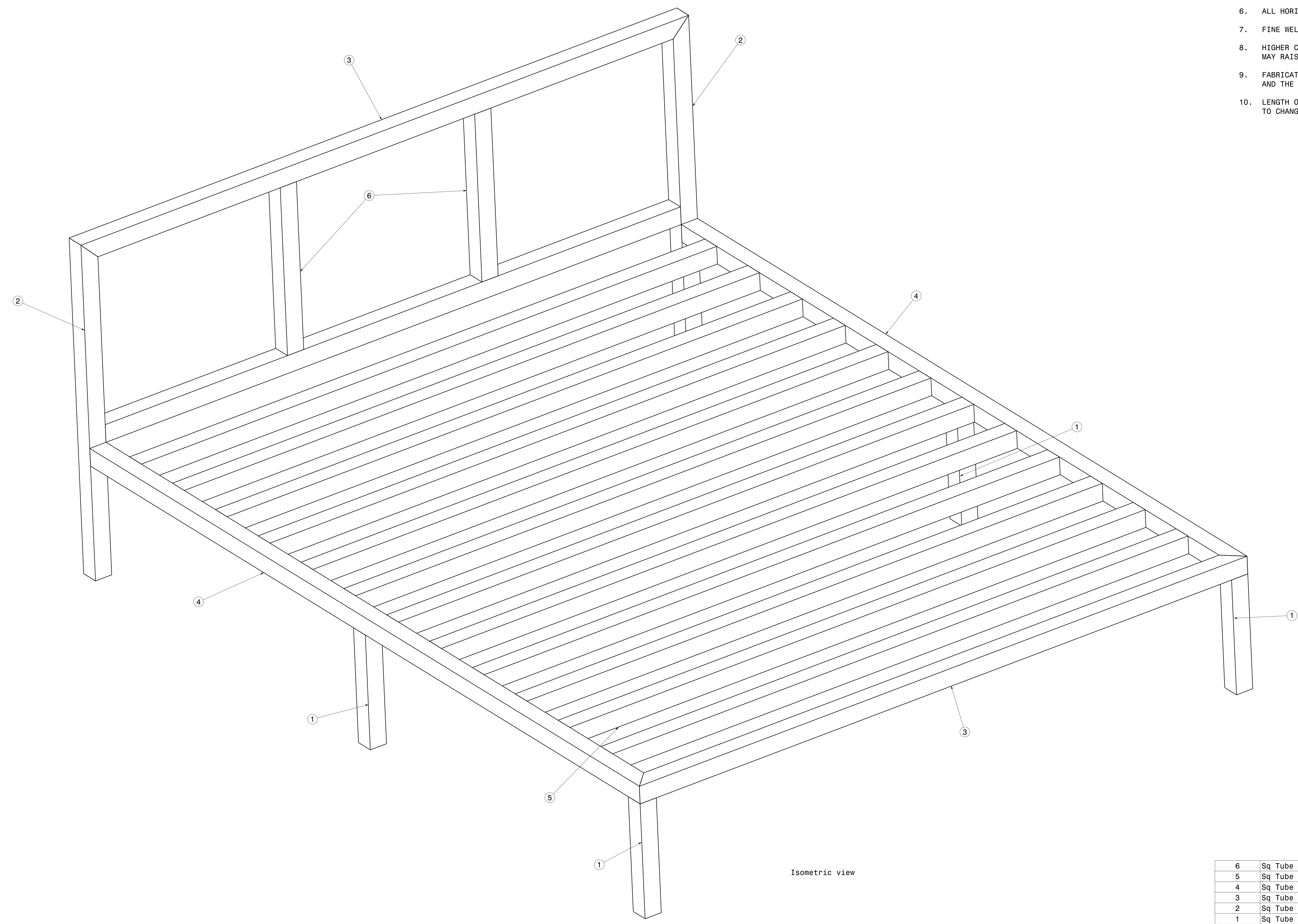

ITEM NO.	PART NUMBER	DESCRIPTION	QTY.	Wt (kg) /Each
6	Sq Tube Bed Frame 6	40 X 40 X 2.9 X 380	2	1.3
5	Sq Tube Bed Frame 5	40 X 40 X 2.9 X 1420	13	4.8
4	Sq Tube Bed Frame 4	40 X 40 X 2.9 X 1860	2	6.2
3	Sq Tube Bed Frame 3	40 X 40 X 2.9 X 1500	2	4.9
2	Sq Tube Bed Frame 2	40 X 40 X 2.9 X 760	2	2.5
1	Sq Tube Bed Frame 1	40 X 40 X 2.9 X 260	4	0.9

This drawing is our property. It can't be reproduced or communicated without our written agreement.		APL APOLLO TUBES LTD.			
DRAWN BY SB		DATE 17/04/2020		DRAWING TITLE BED	
CHECKED BY P2P Analysis & Solutions		DATE 17/04/2020		SIZE A0	DRAWING NUMBER P2P BED
DESIGNED BY P2P Analysis & Solutions		DATE 17/04/2020		SCALE As Indicated	WEIGHT (kg) 0kg
				SHEET 1 OF 5	

UNLESS OTHERWISE SPECIFIED DIMENSION ARE IN MM
VIEWS: THIRD ANGLE PROJECTION

REV	DATE	DESCRIPTION
00	17/04/2020	INITIAL REVISION

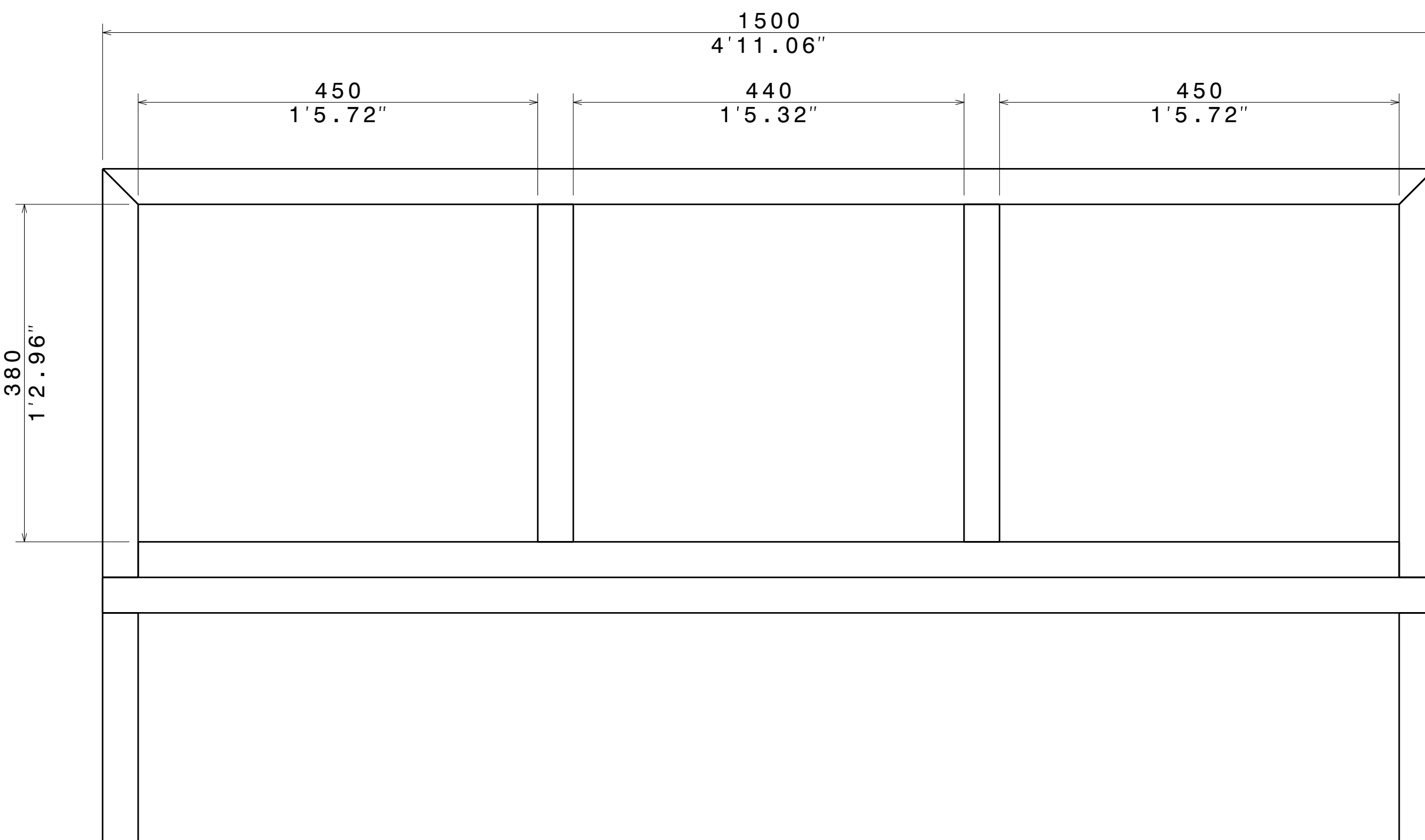
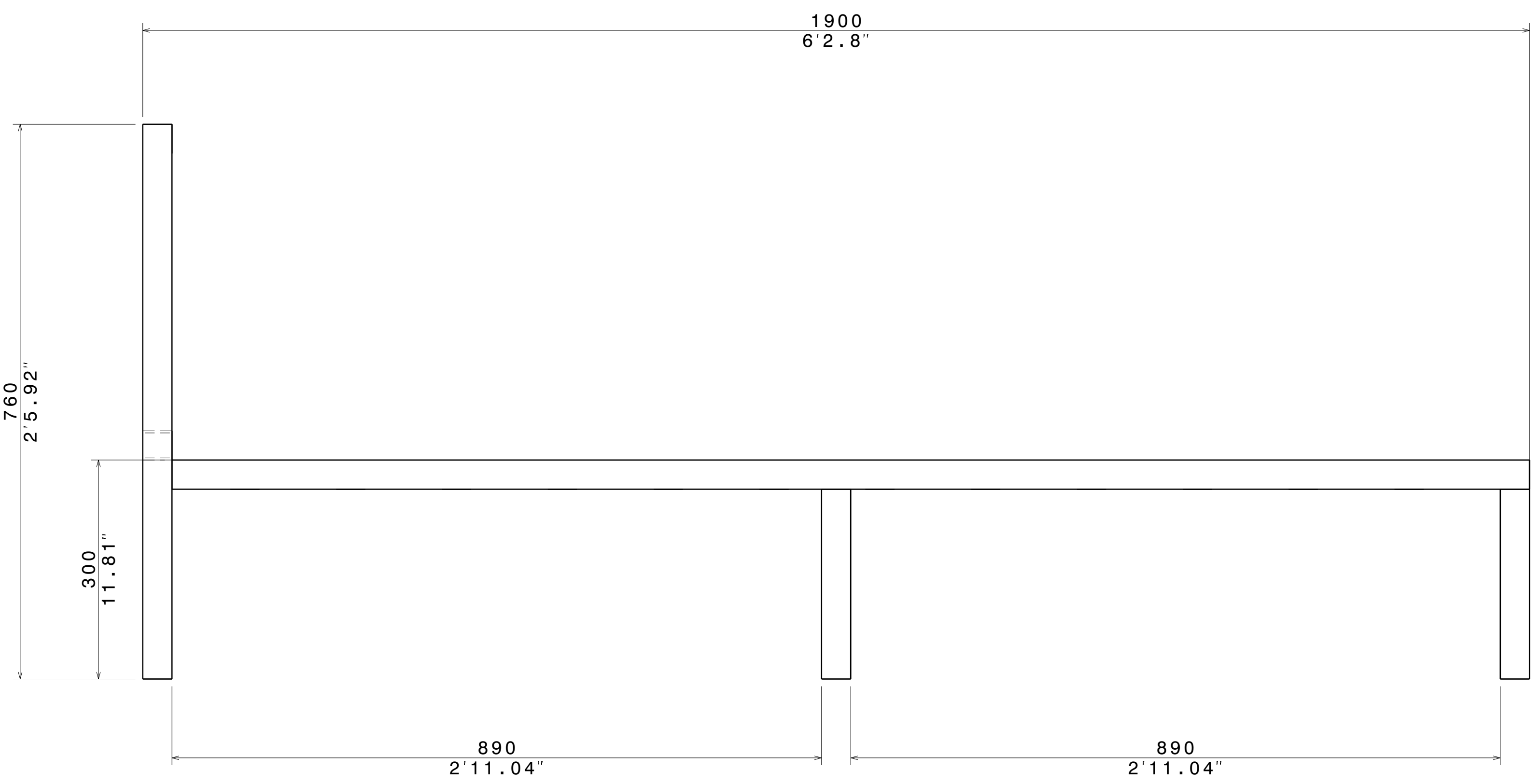
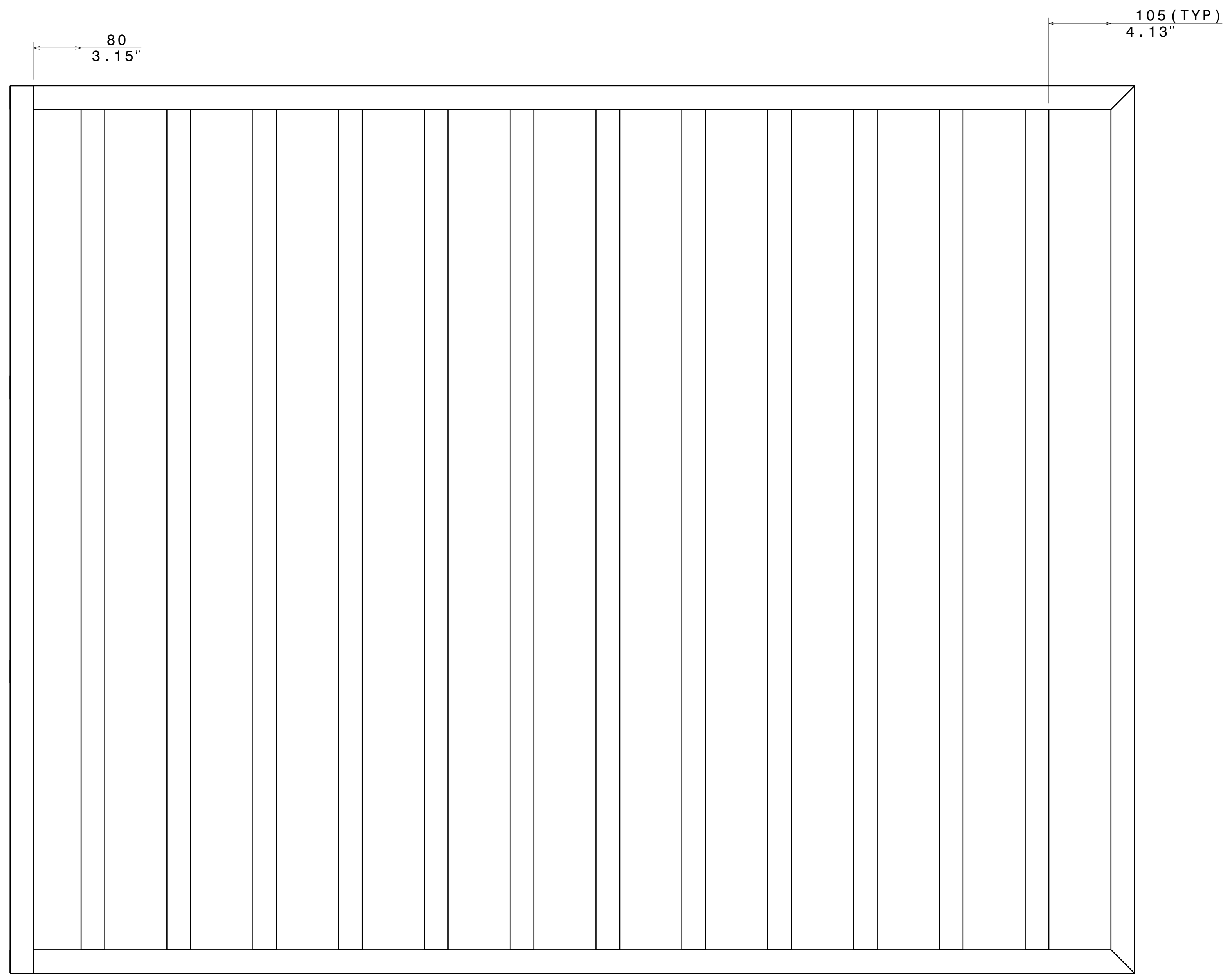

UNLESS OTHERWISE SPECIFIED DIMENSION ARE IN MM
 VIEWS: THIRD ANGLE PROJECTION

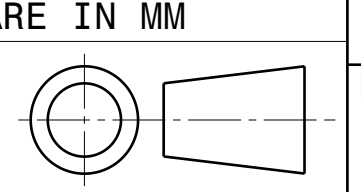

This drawing is our property. It can't be reproduced or communicated without our written agreement.

DRAWN BY	DATE
SB	17/04/2020
CHECKED BY	DATE
P2P Analysis & Solutions	17/04/2020
DESIGNED BY	DATE
P2P Analysis & Solutions	17/04/2020

APL APOLLO TUBES LTD. 

DRAWING TITLE: BED

SIZE	DRAWING NUMBER	REV
A0	P2P BED	00
SCALE	NONE	WEIGHT (kg) XXX

SHEET 2 OF 5

REV	DATE	DESCRIPTION
00	17/04/2020	INITIAL REVISION

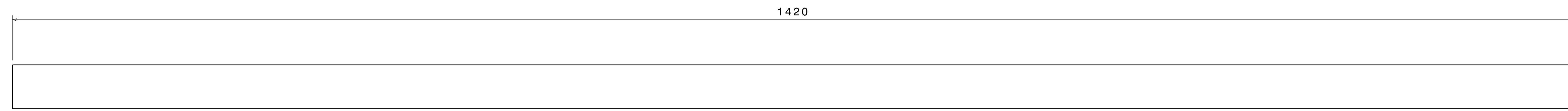

ITEM 5 DETAILS
Sq Tube Bed Frame 5

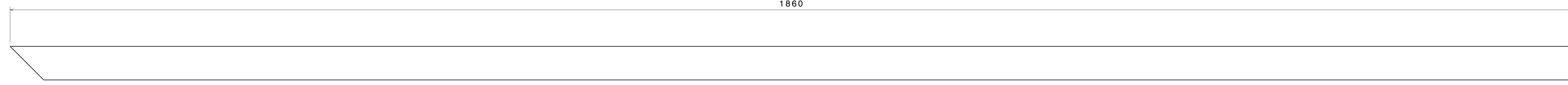

ITEM 4 DETAILS
Sq Tube Bed Frame 4

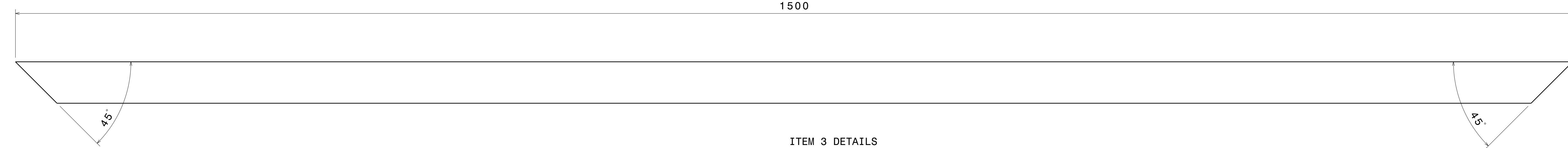

ITEM 3 DETAILS
Sq Tube Bed Frame 3

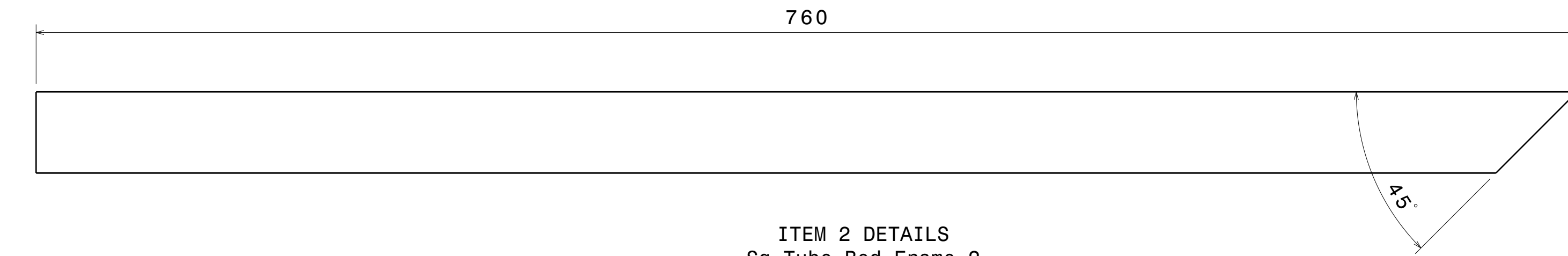

ITEM 2 DETAILS
Sq Tube Bed Frame 2

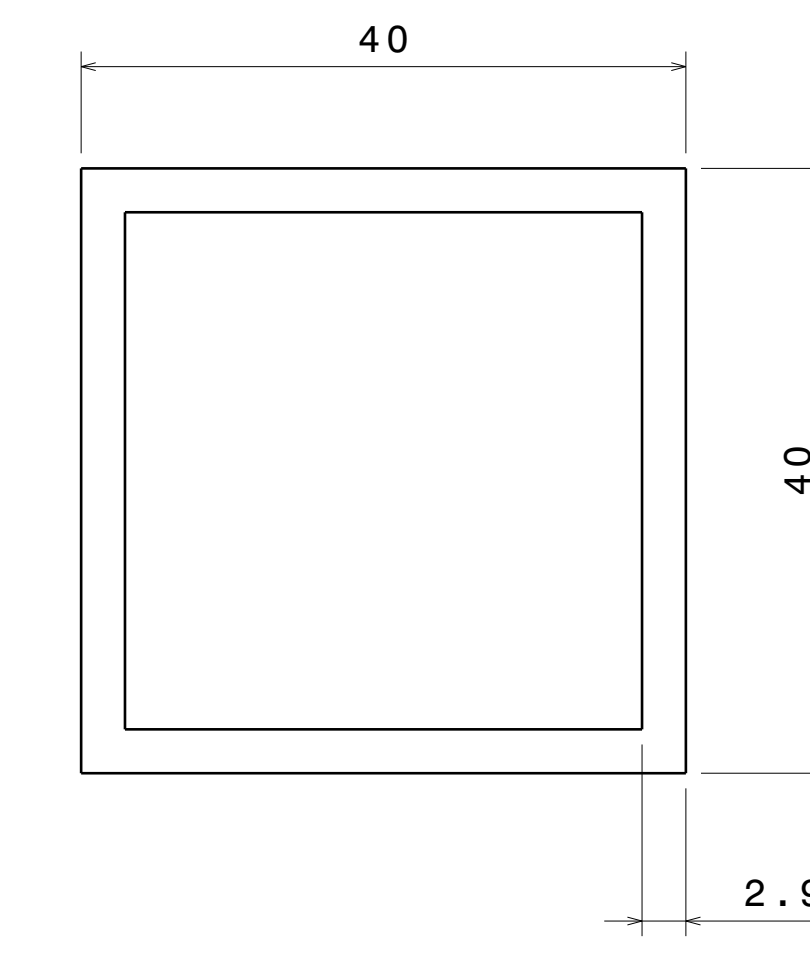

Section Detail of ITEM 1,2,3,4,5 & 6
Scale: 2:1

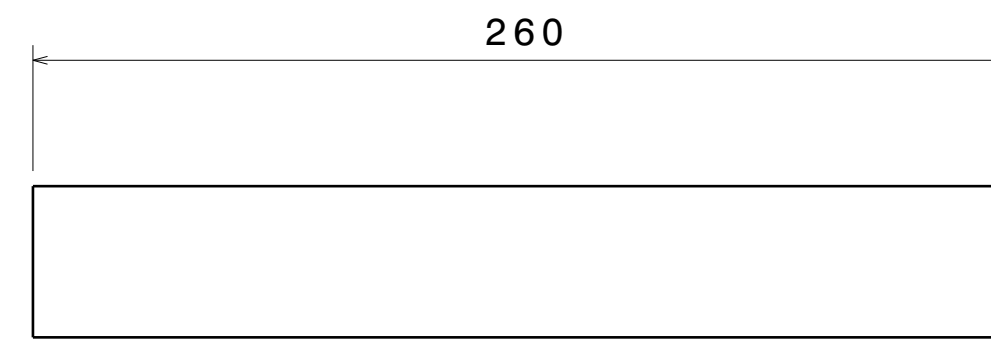

ITEM 1 DETAILS
Sq Tube Bed Frame 1

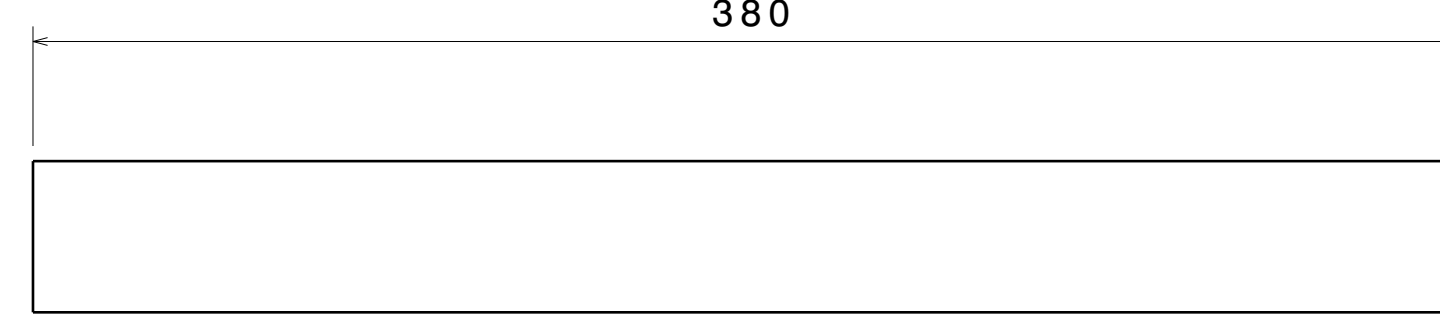

ITEM 6 DETAILS
Sq Tube Bed Frame 6

UNLESS OTHERWISE SPECIFIED DIMENSION ARE IN MM
VIEWS: THIRD ANGLE PROJECTION

This drawing is our property. It can't be reproduced or communicated without our written agreement.

DRAWN BY	DATE
SB	17/04/2020
CHECKED BY	DATE
P2P Analysis & Solutions	17/04/2020
DESIGNED BY	DATE
P2P Analysis & Solutions	17/04/2020

APL APOLLO TUBES LTD.	
DRAWING TITLE	
BED	
SIZE	DRAWING NUMBER
A0	P2P BED
SCALE	WEIGHT (kg)
NONE	XXX
REV	SHEET 3 OF 5
00	