

			DO NOT SCALE DRAWING		REVISION
			TITLE:		
	NAME	SIGNATURE	DATE	DWG NO. <b>CENTER TABLE 9</b>	
DRAWN					
CHK'D					
APPVD				SCALE:1:20	SHEET 1 OF 3
					<b>A4</b>

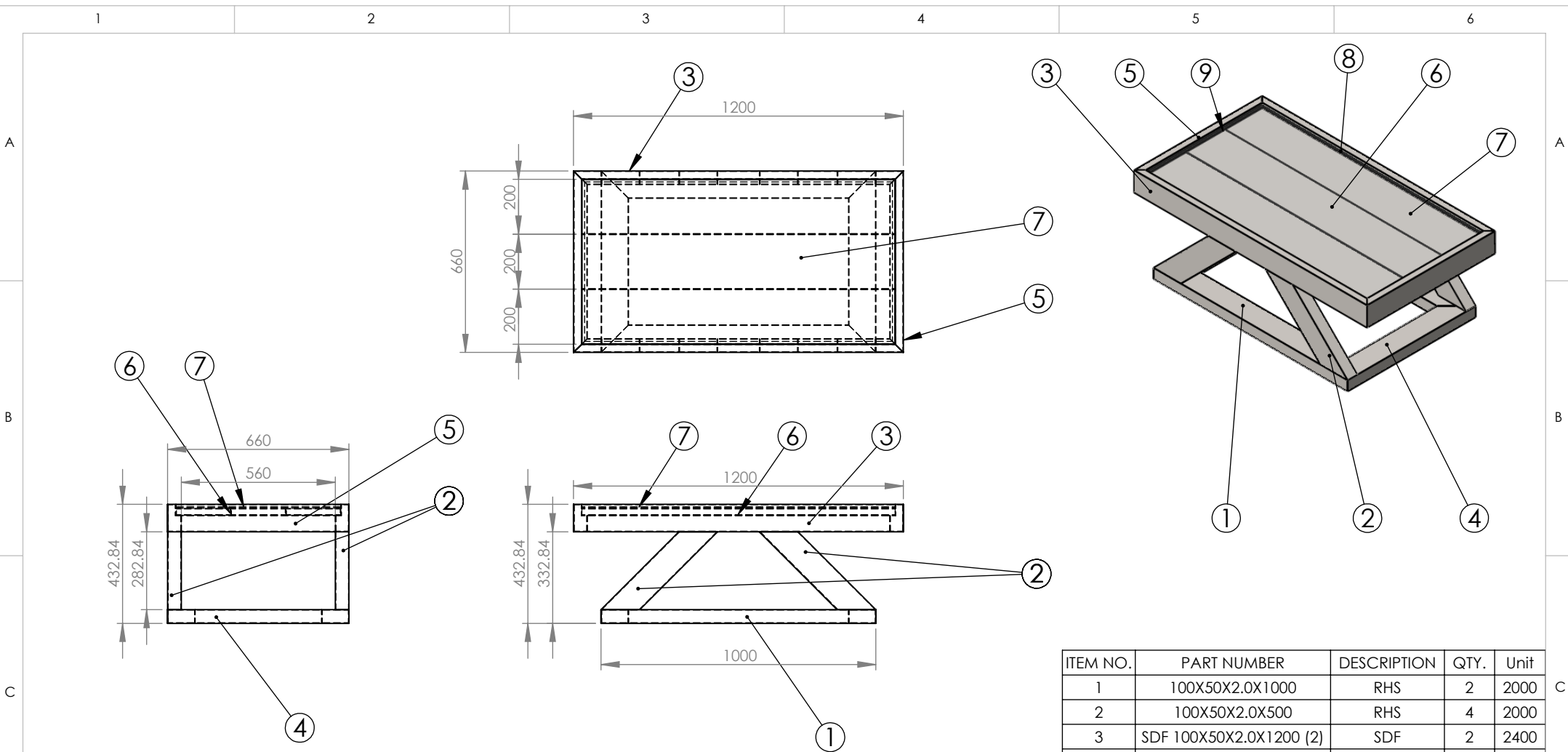

**NOTE :-**

- ALL VERTICAL AND HORIZONTAL SUPPORTS ARE PERFECTLY 90°.
- ∇∇ SURFACE FINISH, MEDIUM TO SMOOTH IS USED.
- ALL TUBES ARE AS PER APL APOLLO STANDARD.
- FINE WELDING IS REQUIRED AS PER MENTION DETAILS AND FINISHING.
- JOINTS ARE WELD TOGETHER BY THE HIGH ACCURACY MIG WELDING.
- ALL DIMENSIONS ARE IN MM.
- HIGHER CURRENT WELDING MAY EFFECT THE BRITTLINESS OF MATERIAL WHICH MAY RAISE TO WEAKENING OF STRUCTURE.

ITEM NO.	PART NUMBER	DESCRIPTION	QTY.	Unit
1	100X50X2.0X1000	RHS	2	2000
2	100X50X2.0X500	RHS	4	2000
3	SDF 100X50X2.0X1200 (2)	SDF	2	2400
4	100X50X2.0X660	RHS	2	1320
5	SDF 100X50X2.0X660	SDF	2	1320
6	PLANK 200X25X2.0X1140	PLANK	3	3420
7	TOUGHENED GLASS 1140X600X10	GLASS	1	
8	RUBBER 1140X10X5	RUBBER	2	
9	RUBBER 600X10X5	RUBBER	2	



DO NOT SCALE DRAWING

REVISION

	NAME	SIGNATURE	DATE	
DRAWN				DWG NO. <b>CENTER TABLE 9</b>
CHK'D				
APPV'D				

SCALE:1:20

SHEET 2 OF 3

**A4**

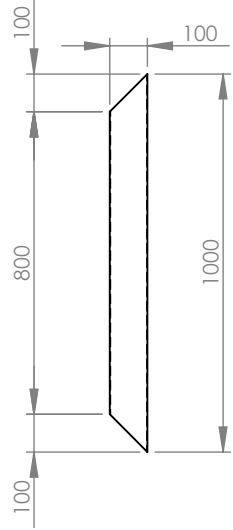

ITEM 1  
RHS 100X50X2.0X1000

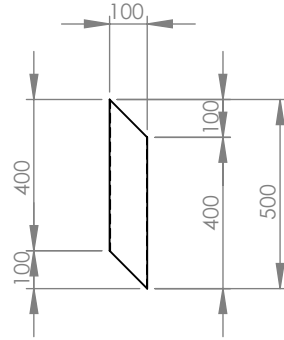

ITEM 2  
RHS 100X50X2.0X500

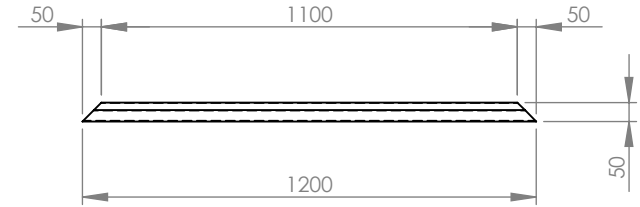

ITEM 3  
SDF 100X50X2.0X1200 (2)

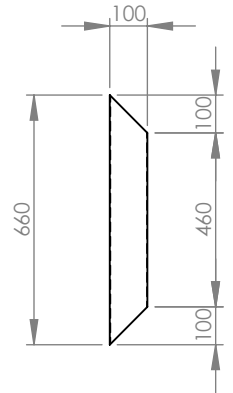

ITEM 4  
RHS 100X50X2.0X660

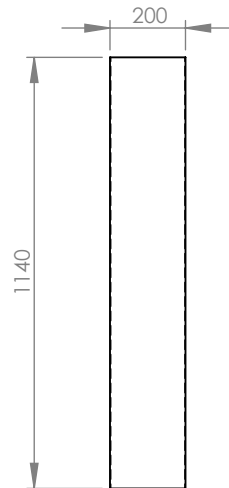

ITEM 5  
PLANK 200X25X2.0X1140

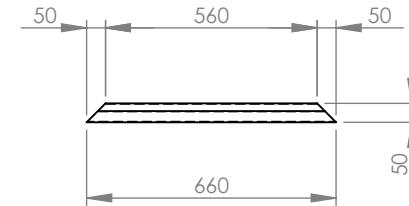

ITEM 6  
SDF 100X50X2.0X660



DO NOT SCALE DRAWING

REVISION

TITLE:

PART DRAWINGS

	NAME	SIGNATURE	DATE
DRAWN			
CHK'D			
APPVD			

DWG NO.

CENTER TABLE 9

SCALE:1:20

SHEET 3 OF 3

A4